

# SOLUS ULTRA™

QUICK-START GUIDE

[diagnostics.snapon.com/solusultra](http://diagnostics.snapon.com/solusultra)

**Snap-on**

# **SOLUS Ultra™**

## **Quick Start Guide**

**September 2011**

**EAZ0075L00A Rev. C**

---

## **Trademarks**

Snap-on, SOLUS Ultra, and Scanner are trademarks of Snap-on Incorporated.

All other marks are trademarks or registered trademarks of their respective holders.

## **Copyright Information**

©2011 Snap-on Incorporated. All rights reserved.

## **Disclaimer of Warranties and Limitation of Liabilities**

The information, specifications and illustrations in this manual are based on the latest information available at the time of printing. While the authors have taken due care in the preparation of this manual, nothing contained herein:

- Modifies or alters in any way the standard terms and conditions of the purchase, lease, or rental agreement under the terms of which the equipment to which this manual relates was acquired.
- Increases in any way the liability to the customer or to third parties.

Snap-on reserves the right to make changes at any time without notice.

---

### **IMPORTANT:**

Before operating or maintaining this unit, please read this manual carefully paying extra attention to the safety warnings and precautions.

---

### **Visit our websites at:**

<http://diagnostics.snapon.com> (North America)

[www1.snapon.com/diagnostics/uk](http://www1.snapon.com/diagnostics/uk) (United Kingdom)

### **For Technical Assistance Call**

1-800-424-7226 (North America)

CALL +44 (0) 845 601 4736 (United Kingdom)

E-mail [DiagnosicsUKproductsupport@snapon.com](mailto:DiagnosicsUKproductsupport@snapon.com) (United Kingdom)

---

# Contents

<b>Connections and Controls</b> .....	<b>4</b>
Connections.....	4
Controls .....	5
<b>Basic Steps</b> .....	<b>6</b>
Battery Pack Installation .....	6
Power Supply Connection .....	7
Powering on the SOLUS Ultra.....	7
<b>Navigation</b> .....	<b>8</b>
Title Bar .....	8
Toolbar .....	8
Screen Messages.....	11
<b>Operations</b> .....	<b>12</b>
Scanner .....	12
OBD-II/EOBD .....	13
Previous Vehicles & Data .....	13
Tools.....	14
Demonstration Program .....	14
Printing and Storing Saved Data .....	15
<b>SOLUS Ultra Kit Contents</b> .....	<b>16</b>

# Connections and Controls

## Connections

All of the ports for connecting the SOLUS Ultra to a vehicle, personal computer, or power source are located on the top panel of the unit.

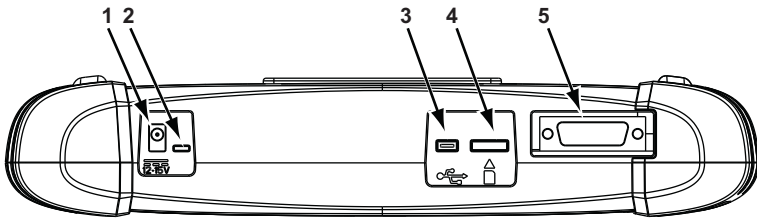

- 1— **DC Power Supply Input Port**—use for connecting the AC/DC power supply.
- 2— **Battery Status Indicator**—a multi-color light emitting diode (LED) that illuminates to indicate battery status, interpret as follows:
  - Green indicates the battery is fully charged
  - Red indicates the battery is being charged
  - Amber indicates a battery issue. This is usually caused by excessive battery temperature (above 104°F/40°C), which disables charging. Allow the unit to cool down and make sure the ventilation ports are not obstructed if the LED is amber.
- 3— **Mini USB Client Port**—use for connecting the scan tool to a personal computer.
- 4— **Micro secure digital (uSD) Card Port**—holds the uSD card that contains the operating system programming.
- 5— **Data Cable Port**—use for connecting the scan tool to a test vehicle.

**Figure 2-1** *Connections*

**IMPORTANT:**

The uSD card must be installed for the scan tool to operate. Do not remove the uSD card while the unit is powered on.

## Controls

The external controls on the SOLUS Ultra are simplified since most operations are controlled through the touch screen. Touch screen navigation is menu driven, which allows you to quickly locate the needed test, procedure, or data through a series of choices and questions.

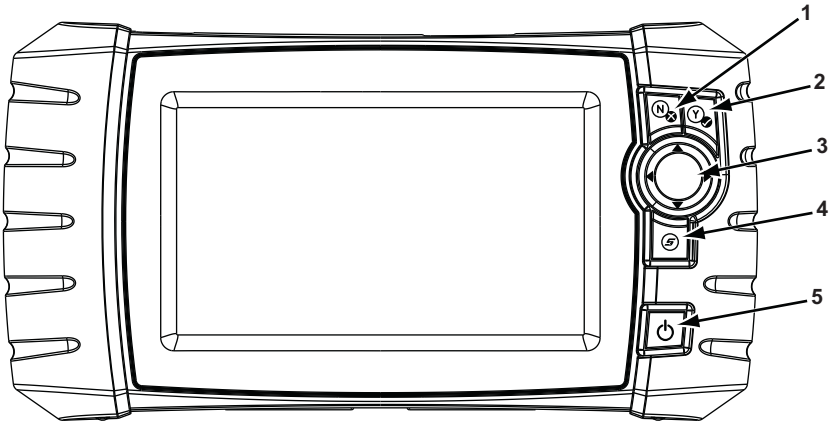

- 1— **N/x Button**—exits a menu or program, returns to the previous screen, or answers no to a question on the screen.
- 2— **Y/✓ Button**—selects a menu or program, advances to the next screen, or answers yes to a question on the screen.
- 3— **Directional Buttons**—moves the highlight on the display screen up (▲), down (▼), left (◀), and right (▶), as indicated by the arrows.
- 4— **Shortcut Button**—can be programmed to provide a shortcut for performing a variety of routine tasks.
- 5— **Power Button**—switches the unit on and off.

**Figure 2-2** Controls

# Basic Steps

To begin operating your SOLUS Ultra scan tool:

1. Install the battery pack (2-04650A) into the SOLUS Ultra unit (EESC318).
2. Connect the AC/DC power supply to the SOLUS Ultra unit to charge the battery pack.
3. Power on the scan tool.

## Battery Pack Installation

Use the following procedure to install the battery pack.



### To install the battery pack:

1. Loosen the two captive screws that secure the battery cover to the back of the unit.
2. Lift to open the battery cover.

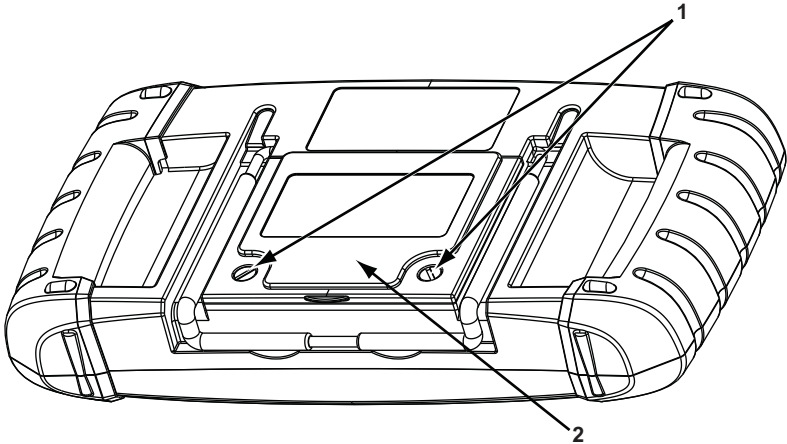

**1— Captive Screws**

**2— Battery Cover**

**Figure 3-1** *Battery pack*

3. Position the new battery pack and slide it into its seated position in the battery compartment.
4. Make sure the battery pack is fully seated.
5. Fit the battery cover.
6. Tighten the two captive screws.

## Power Supply Connection

Use the following procedure to connect the power supply.



### To connect the AC/DC power supply:

1. Insert the power cord of the AC/DC power supply into a service outlet.
2. Fit power supply cable jack into the DC port (marked 10-30V) on the top of the SOLUS Ultra unit.

An LED alongside the DC port illuminates to indicate power is being supplied. Once the scan tool is powered on, an icon in the upper right corner of the display screen indicates the battery state of charge, refer to the *SOLUS Ultra User Manual* for details.

## Powering on the SOLUS Ultra

The SOLUS Ultra unit will be switched on when the AC/DC power supply is connected, there is no need to wait for the battery pack to be charged. Press the power button on the face of the unit to switch the SOLUS Ultra unit on, the scan tool initializes and opens to the Home screen.



**Figure 3-2** Power button



---

# Navigation

Scan tool screens typically include three sections:

- **Title bar**—shows test and tool status
- **Toolbar**—contains test controls
- **Main body**—displays menus and test data

## Title Bar

The title bar at the top of the screen, provides information about current tool operating conditions. Title bar options vary depending upon vehicle make and model, what test is being performed or what menu is selected.













Depending upon what is being displayed in the main body of the screen, either the vehicle ID or the active menu is shown at the left side of the title bar.

An icon at the far right side of the title bar indicates whether the tool is being powered by the internal battery pack, the test vehicle, or the AC/DC power supply.

A communication icon displays to the left of the power source indicator whenever the scan tool is actively communicating with a test vehicle or a personal computer.

## Toolbar

The toolbar, located under the title bar, contains a number of selectable buttons that control tool functions. What buttons appear on the toolbar varies, as only buttons that are active or available for the current screen and test mode display. A brief description of common toolbar button operations are shown in the table that follows:

Button	Icon	Function
Back		Returns to the previously viewed screen. This button is always at the left-hand edge of the toolbar.
Home		Returns to the Home screen. This button is always alongside the Back button on the left side of the toolbar.
Custom Data List		Allows you to select which parameters to display from the list. This button displays when viewing a data list.
Graph		Switches between PID List and Graph display modes. This button displays when viewing a data list.
Lock/Unlock		Locks or unlocks the highlighted parameter. This button displays when viewing a data list.
Save		Saves the current datastream information to tool memory.
Tools		Opens the tools menu, which allows you to adjust basic tool settings.
Pause		Indicates live data from the vehicle is being displayed.
Play		Indicates the data being displayed is paused when reviewing a movie.
Previous Frame		Moves back one frame when viewing recorded or paused data.
Next Frame		Moves forward one frame when viewing recorded or paused data.
PID Triggering		Opens a menu that allows you to set, arm, and clear threshold values to automatically begin recording data.
Zoom		Increases and decreases the scale of the data graphs.

## 4.1 Main Body

The main body is the lower portion of the screen, which displays a menu of available tests or data from the vehicle. A vertical scroll bar appears when there is additional data either above or below what is currently shown on the screen.



- 1— Go to beginning
- 2— Go up 1 page
- 3— Slider (position indicator)
- 4— Go down 1 page
- 5— Go to end

**Figure 4-1** *Sample scroll bar*

Tap the arrowheads at the ends of the scroll bars to move in the direction of the arrow one page at a time. An arrowhead that points to a line moves you directly to the top, bottom, beginning, or end of the data. The slider in the center portion of the scroll bar indicates the relative position of the current screen to the total available data.

# Screen Messages

Four types of on-screen messages may display while operating the scan tool:

- Loading and connecting
- Confirmations
- Warnings
- Errors

## Loading and Connecting Messages

Loading and connecting messages display when the scan tool is performing an internal operation, such as loading a database, initiating a test, or establishing communications with the vehicle. The message automatically clears once the internal operation is complete.

## Confirmation Messages

Confirmation messages display when the action you are about to perform cannot be reversed, or when the selected action requires an acknowledgment to continue.

When a response is not required, the message displays briefly, then disappears.

## Warning Messages

Warning messages inform that completing the selected action may result in an irreversible change or loss of data.

## Error Messages

Error messages display when a system or procedural error, such as a cable disconnection or loss of signal, occurs.

# Operations

The Home screen opens when SOLUS Ultra is powered on. Touch-sensitive buttons on the Home screen are used to select from the four primary functions of the scan tool:

- Scanner
- OBD-II/EOBD
- Previous Vehicles & Data
- Tools

## Scanner



The **Scanner** button opens a list of available vehicle manufacturers and begin the process of identifying the vehicle to be tested.

Because the scan tool presents data provided by the ECM of the vehicle being tested, certain attributes of the test vehicle must be entered into the scan tool to ensure the data displays correctly.

The vehicle identification sequence is menu driven, simply follow the screen prompts and make a series of choices. Each selection advances you to the next screen. Exact procedures may vary somewhat by the make, model, and year of the test vehicle.

A confirmation screen displays once all of the identification information has been entered. Select **OK** at the confirmation screen to continue. The database for the identified vehicle loads and a list of systems available for testing displays.

## OBD-II/EOBD



The **OBD-II/EOBD** button opens a menu that allows you to perform generic OBD-II/EOBD system tests without first identifying a specific vehicle. The OBD-II/EOBD menu includes:

- OBD Health Check
- OBD Diagnose

OBD Health Check offers a way to quickly check for and clear generic diagnostic trouble codes (DTCs) and to check readiness monitors. Selecting opens a submenu of options, chose from the submenu and follow the screen prompts.

OBD Diagnose opens a menu with the following options:

- Start Communication—begins the test session.
- Select Communication Protocol—allows you to select which communication protocol to use.
- Connector Information—provides data link connector (DLC) location details for most models.

## Previous Vehicles & Data



The **Previous Vehicles & Data** button allows you to quickly configure the scan tool to the identity of a recently tested vehicle, and to access saved data files. A menu with three options opens when this button is selected:

- Vehicle History—opens a list you can use to recall the identification information of previously tested vehicles.
- View Saved Data—opens a list of all the data movies and screen images that are stored in scan tool memory.
- Delete Saved Data—allows you to permanently erase saved files from scan tool memory.

## Tools



The **Tools** button allows you to adjust tool settings to your personal preferences, access scan tool system information, and perform other special operations.

Selecting **Tools** opens a menu of options:

- **Connect To PC**—use to transfer and share files with a personal computer (PC).
- **Configure Shortcut Button**—use to change the functionality of the shortcut button.
- **System Information**—use to display configuration information for your scan tool.
- **Settings**—use to configure certain characteristics of the scan tool.
- **Configure Units**—use to choose between US customary or metric units of measure.

Selecting a menu item either opens a submenu of additional choices or a dialog box that includes instructions. Choose from the menus and follow the screen prompts to configure your SOLUS Ultra to your preferences.

## Demonstration Program

Your SOLUS Ultra includes a demonstration program that allows you to become familiar with many of the capabilities of the scan tool without actually connecting to a vehicle. Sample data and mock test results help you quickly learn how to navigate the menus and perform basic operations.



### To start the demonstration program:

1. From the Home screen, tap **Scanner**.  
The manufacturer menu, which lists all of the makes available for testing, displays. The list also includes a **Demonstration** button.
2. Tap the **Demonstration** button to select it.

A screen advising you are in simulation mode displays, select **Continue**.



---

**NOTE:**

The demonstration takes you through a simulated vehicle identification process, simply accept the default data as it displays on the screen to continue.

---

3. Follow the on-screen instructions and select as needed until the Systems menu displays.
  4. Select **OK** on the confirmation screen to load the selected database.
  5. Select **OK** from the Demo mode message screen. A systems menu, which shows all of the systems available for testing, displays
  6. Select from any of the systems listed, then select from the submenus.
- 

**IMPORTANT:**

Do not connect a vehicle to the scan tool while in the Demonstration mode.

---

## Printing and Storing Saved Data

The SOLUS Ultra does not directly interface with a printer. Instead, the scan tool connects to your personal computer (PC) through the USB port (see Tools & Setup). Once connected to the PC, SOLUS Ultra files can be printed, transferred, and copied using ShopStream Connect. ShopStream Connect is a free software application download available at:

*<http://diagnostics.snapon.com/ssc>*



# SOLUS Ultra Kit Contents

---

**IMPORTANT:**

Be sure to read all of the safety messages in the Important Safety Instructions provided before operating this product.

---

Remove all of the SOLUS Ultra components from the packaging and verify the contents:

**Table 6-1** *SOLUS Ultra kit contents*

Description	Part Number	Description
SOLUS Ultra	EESC318	Scan tool assembly
Battery Pack	2-04650A	Lithium-ion battery
Power Supply	2-60666A	AC/DC Power Supply
Scanner Cable Assembly Set	EAX0068L00B	OBD II Cable Assembly
	EAX0066L05B	USB Cable (Micro B to Host)
Carrying Case	EAC0088L17C	Plastic Case
Information Packet	EAZ0042B15B	Important Safety Instructions
	EAZ0075L00A	Quick Start Guide
	3-58528A00C1	Documentation CD
	8-13963A03	Software License Agreement
	8-15163A01	Warranty Statement
	EAZ0042L30A	Registration Notice