

VERLIS® Edge

User Manual



ZEEMSAU330A Rev. E

Legal Information

Trademarks

Snap-on, ShopStream Connect, SureTrack, Fast-Track Troubleshooter, ProDemand, ShopKey Pro and VERUS are trademarks registered in the United States and other countries of Snap-on Incorporated. All other marks are trademarks or registered trademarks of their respective holders.

The *Bluetooth* word mark and logos are registered trademarks owned by Bluetooth SIG, Inc. and any use of such marks by Snap-on Incorporated is under license.

Copyright Information

© 2018 Snap-on Incorporated. All rights reserved.

Disclaimer of Warranties and Limitation of Liabilities

All pictures and illustrations shown are for reference purposes only. All information, specifications and illustrations in this manual are based on the latest information available at the time of printing and are subject to change without notice. While the authors have taken due care in the preparation of this manual, nothing contained herein:

- Modifies or alters in any way the standard terms and conditions of the purchase, lease, or rental agreement under the terms of which the equipment to which this manual relates was acquired.
- Increases in any way the liability to the customer or to third parties.

Snap-on[®] reserves the right to make changes at any time without notice.

IMPORTANT:

Before operating or maintaining this unit, please read this manual carefully paying extra attention to the safety warnings and precautions.

Manuals / Technical Documentation - The information in this manual is periodically revised to ensure the latest information is included. Download the latest version of this manual and other related technical documentation from the Snap-on Diagnostics website.

Software License Information

Use of Software is governed by the terms and conditions of the End User License Agreement. The diagnostic tool should not be initially operated until the End User License Agreement is read. Use of the device acknowledges your acceptance of the End User License Agreement. The Snap-on Incorporated Software End User License Agreement may be provided with the diagnostic tool, and is available at: <https://eula.snapon.com/diagnostics>

Patent Information

For a listing of Snap-on products that are protected by patents in the United States and elsewhere, visit: <https://patents.snapon.com>

Contact Information (Australia and New Zealand)

Visit our websites at:

<http://snapontools.com.au>

http://www.snapontools.com.au/diagnostics/diagnostic_helpdesk_registration

ShopStream Connect

http://snapontools.com.au/diagnostics/downloads/shopstream_connect_software

For Technical Assistance

Phone / E-mail:

(Australia) 1800 810 581 / sota.diagnostics@snaapon.com

(New Zealand) 0800 762 766 / sota.diagnostics@snaapon.com

For technical assistance in all other markets, contact your selling agent.

IMPORTANT INFORMATION

Operating System (OS)

Your VERUS[®] Edge delivers exclusive coverage, more capabilities, superior performance and runs on a special version of the Microsoft[®] Windows[®] 7 operating system.

DO NOT install another operating system on this diagnostic tool. The modification or installation of a different OS or OS version will damage the diagnostic tool and void its warranty.

Safety Information

READ ALL INSTRUCTIONS

For your own safety, the safety of others, and to prevent damage to the product and vehicles upon which it is used, it is important that all instructions and safety messages in this manual and the accompanying *Important Safety Instructions* manual be read and understood by all persons operating, or coming into contact with the product, before operating. We suggest you store a copy of each manual near the product in sight of the operator.

For your safety, read all instructions. Use your diagnostic tools only as described in the tool user's manual. Use only manufacturer recommended parts and accessories with your diagnostic tools.

This product is intended for use by properly trained and skilled professional automotive technicians. The safety messages presented throughout this manual and the accompanying *Important Safety Instructions* manual are reminders to the operator to exercise extreme care when using this product.

There are many variations in procedures, techniques, tools, and parts for servicing vehicles, as well as in the skill of the individual doing the work. Because of the vast number of test applications and variations in the products that can be tested with this instrument, we cannot possibly anticipate or provide advice or safety messages to cover every situation. It is the responsibility of the automotive technician to be knowledgeable of the system being tested. It is essential to use proper service methods and test procedures. It is important to perform tests in an appropriate and acceptable manner that does not endanger your safety, the safety of others in the work area, the equipment being used, or the vehicle being tested.

It is assumed that the operator has a thorough understanding of vehicle systems before using this product. Understanding of these system principles and operating theories is necessary for competent, safe and accurate use of this instrument.

Before using the equipment, always refer to and follow the safety messages and applicable test procedures provided by the manufacturer of the vehicle or equipment being tested. Use the product only as described in its user manual. Use only manufacturer recommended parts and accessories with your product.

Read, understand and follow all safety messages and instructions in this manual, the accompanying *Important Safety Instructions* manual, and on the test equipment.

Environmental Conditions:

- This product is intended for indoor use only
- This product is rated for Pollution Degree 2 (normal conditions)

Safety Signal Words

All safety messages contain a safety signal word that indicates the level of the hazard. An icon, when present, gives a graphical description of the hazard. Safety Signal words are:

DANGER

Indicates an imminently hazardous situation which, if not avoided, will result in death or serious injury to the operator or to bystanders.

WARNING

Indicates a potentially hazardous situation which, if not avoided, could result in death or serious injury to the operator or to bystanders.

CAUTION

Indicates a potentially hazardous situation which, if not avoided, may result in moderate or minor injury to the operator or to bystanders.

Safety Message Conventions

Safety messages are provided to help prevent personal injury and equipment damage. Safety messages communicate the hazard, hazard avoidance and possible consequences using three different type styles:

- Normal type states the hazard.
- **Bold type states how to avoid the hazard.**
- *Italic type states the possible consequences of not avoiding the hazard.*

An icon, when present, gives a graphical description of the potential hazard.

Safety Message Example

WARNING



Risk of unexpected vehicle movement.

- **Block drive wheels before performing a test with engine running.**

A moving vehicle can cause injury.

Important Safety Instructions

For a complete list of safety messages, refer to the accompanying *Important Safety Instructions manual*.

SAVE THESE INSTRUCTIONS

Contents

Safety Information	iv
Contents	vi
Chapter 1: Using This Manual	1
Conventions.....	1
Bold Text.....	1
Symbols	1
Terminology	1
Notes and Important Messages	2
Procedures.....	2
Hyperlinks	2
Tool Help.....	2
Chapter 2: Introduction.....	3
Features and Specifications	3
Diagnostic Tool	3
Scope Module	7
Scan Module (Wireless).....	9
Chapter 3: Basic Operation and Navigation	11
Turning On/Off, Sleep Mode and Emergency Shutdown	11
Turning On	11
Turning Off	11
Sleep Mode	12
Emergency Shutdown	12
Shortcut (S) Button	13
Configure Shortcut (S) Button	14
Advanced (menu selection)	14
Changing the Units of Measurement	15
LED Indicator.....	16
Basic Navigation.....	16
Touch Screen and Stylus.....	16
Starting the ShopStream Diagnostic Suite Program	18
Home Screen Layout	18
Function Icons.....	19
Toolbar	20
Windows Taskbar	22
Virtual Keyboard	22
Camera Operation	24
Operating the Camera	24
Viewing Pictures	25
Wi-Fi Setup.....	25
Printing / Printer Setup	27
USB Printer Setup.....	27
Wireless Printer Setup	28

Default Printer Setting	30
Checking/Installing Adobe® Reader	31
Chapter 4: Scanner Function	32
Demonstration Program	32
Basic Operation and Navigation	33
Screen Messages	33
Making Selections	33
Scanner Screen Layout	34
Menu Options	42
Scanner Operation	45
Vehicle Identification	45
Connecting the Scan Module	46
Vehicle System Selection	47
Saving the Vehicle System Report	50
Vehicle Test Selection	53
Stopping Communication and Exiting the Scanner	64
Chapter 5: Scan Module Operation	65
Overview	65
Pairing The Scan Module	66
Checking Scan Module Paired Status	67
Data Cable Connection	68
Troubleshooting	69
No Communication Message	69
Signal Loss / Out of Range Alarm	69
Checking Hardware Status	70
Recovery Procedure	72
Updating Scan Module Firmware	74
Chapter 6: OBD Direct Operations	78
OBD Health Check	79
Global OBD II Code Check	79
Global OBD II Clear Codes	80
Readiness Monitors	80
MIL Status	81
OBD Diagnose	81
Start Communication	81
Connector Information	85
Manual Protocol Selection	85
Chapter 7: Guided Component Test Operations	86
Vehicle Identification	86
Menu Options, Guided Component Test	87
Creating a Favorites List	87
Identifying a Test Vehicle	88
Training and Classes	90
Features Benefits	91
Power User Tests	91
How To	91
Operations	91

Component Information	92
Tests	93
Chapter 8: Scope and Multimeter Operations	97
Using the Scope Module Remotely	97
Getting Started	99
Capabilities	99
Leads, Probes and Adapters	100
Menu Options, Scope Multimeter.....	103
Navigation.....	105
Screen Layout.....	105
Making Selections.....	109
Operations.....	110
Starting the Scope and Multimeter.....	110
Measurement Out of Range.....	112
Scope and Multimeter Setup.....	112
Chapter 9: Vehicle History Operations.....	126
Screen Layout	126
Vehicle History Main Body (Records List).....	126
Vehicle History Toolbar	127
Chapter 10: Data Manager Operations	132
Screen Layout	132
Navigation	133
Operations	134
My Data.....	134
Up	134
Open	134
New.....	135
Delete.....	136
Rename	137
Properties.....	138
Shortcut.....	138
Email	139
Vehicle System Report Data Folder	144
Vehicle System Report Data	144
Viewing Saved Files	145
ShopStream Connect™	145
Saved File Structure	145
Scanner DataViewer Operation.....	146
Menu Bar	147
Display Toolbar	150
Navigation Tools	151
Customizing the Display.....	153
Customizing the Parameter List.....	154
Scope Viewer	156
Image Viewer	157
Chapter 11: Help Operations	158
Using the Help Toolbar.....	158

- Chapter 12: System Settings Operations 159**
 - Paired Devices 159
 - Scan Module Pairing 160
 - Paring the M2 Scope/Meter (optional equipment)..... 161
 - Shop Information 164
 - Code Scan (Timestamp)..... 165
 - Data Backup 166
 - Backup Settings (message) 166
 - Backup 166
 - Restore 167

- Chapter 13: ShopStream Update Tool (SST) 168**
 - Basic Operation 168
 - End User License Agreement..... 170
 - Manual Download..... 171
 - Installing Software Updates..... 173
 - Installing Software Upgrades..... 174

- Chapter 14: Maintenance 176**
 - Diagnostic Tool..... 176
 - Cleaning 176
 - Cleaning the Touch Screen 176
 - Battery Service..... 176
 - Calibrating the Touch Screen 180
 - Screen Protector Installation..... 181
 - Stylus Tip Replacement 183
 - Operating System Restore..... 184
 - Scan Module..... 184
 - Cleaning and Inspecting the Scan Module 184
 - Replacing the Protective Handgrip..... 184

This manual contains basic operating instructions and is structured in a manner to help you become familiar with your diagnostic tool features and perform basic operations.

The illustrations in this manual are intended as reference only and may not depict actual screen results, information, functions or standard equipment. Contact your sales representative for availability of other functions and optional equipment.

1.1 Conventions

1.1.1 Bold Text

Bold emphasis is used in procedures to highlight selectable items such as buttons and menu options.

Example:

- Select **Functions**.

1.1.2 Symbols

The “greater than” arrow (>) indicates an abbreviated set of selection instructions.

Example:

- Select **Utilities > Tool Setup > Date**.

The above statement abbreviates the following procedure:

1. Select the **Utilities** icon.
2. Select the **Tool Setup** submenu.
3. Highlight the **Date** option from the submenu.

1.1.3 Terminology

The term “select” describes tapping/touching an icon on the touch screen, or highlighting an icon or menu choice and then selecting the confirmation menu choice such as **Continue, Accept, OK, Yes**, or other similar choice.

Example:

- Select **Reset**.

The above statement abbreviates the following procedure:

1. Navigate to the **Reset** icon.
2. Select the **Reset** icon with your stylus.

1.1.4 Notes and Important Messages

The following messages are used.

Note

A note provides helpful information such as additional explanations, tips, and comments.

Example:

**NOTE:**

For additional information refer to...

Important

Important indicates a situation which, if not avoided, may result in damage to the test equipment or vehicle.

Example:

IMPORTANT:

Disconnecting the USB cable during vehicle communication can cause damage to the ECM.

1.1.5 Procedures

An arrow icon indicates a procedure.

Example:

**To change screen views:**

1. Select **View**.
The dropdown menu displays.
2. Select an option from the menu.
The screen layout changes to the format you selected.

1.1.6 Hyperlinks

Hyperlinks, or links, that take you to other related articles, procedures, and illustrations are available in electronic documents. Blue colored text indicates a selectable hyperlink.

Example:

IMPORTANT:

Read all applicable [Safety Information](#) before using this tool!

1.1.7 Tool Help

To display help topics for this tool, select a help option from the Help menu.

This chapter introduces the basic features of the Diagnostic Tool, including the control buttons, data ports, battery pack, and power sources. Your Diagnostic Tool is a specialized personal automotive diagnostic solution that combines information with test instrumentation to help you diagnose symptoms, codes, and complaints quickly and efficiently. There are three main components to the system:

- **Diagnostic Tool**—central processor and monitor for the system
- **Scope Module**—device for sampling circuits and signals
- **Scan Module**—wireless device for accessing vehicle data

This manual describes the operation of these three devices and how they work together to deliver diagnostic solutions.

2.1 Features and Specifications

2.1.1 Diagnostic Tool

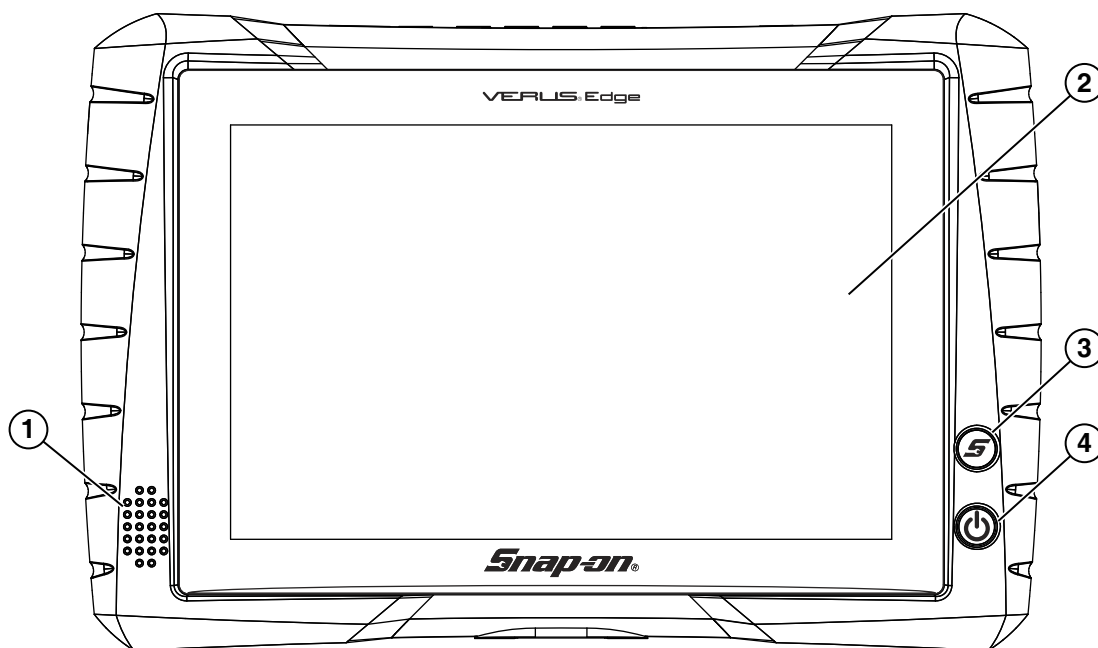

- 1— Audio Speaker
- 2— Capacitive Touch Screen
- 3— Shortcut (S) Button (special functions)
- 4— Power Button (with backlit LED functions)

Figure 2-1 Front view

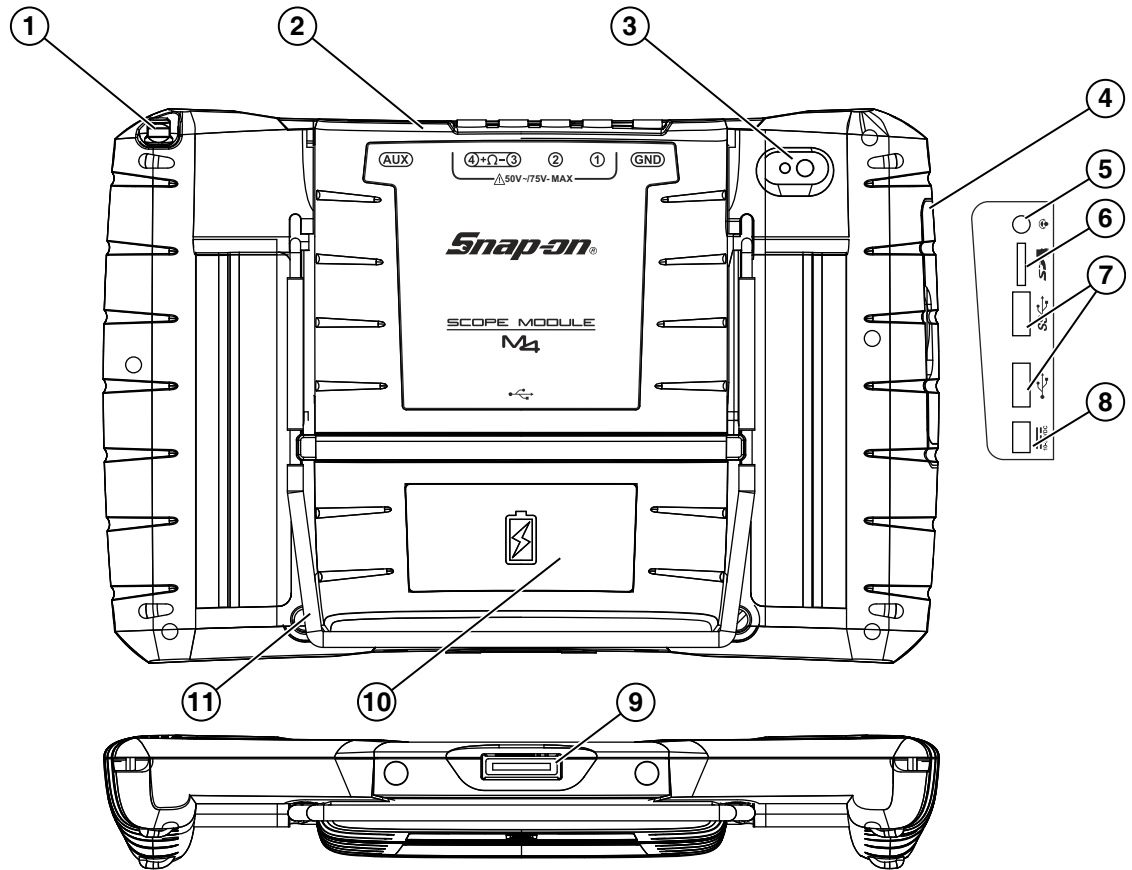

- 1— Stylus Storage
- 2— Scope Module M4 (removable)
- 3— Camera Lens
- 4— Communication and Power Jacks Cover
- 5— Head Phone Jack
- 6— Micro uSD Card Slot
- 7— USB (universal serial bus) Jacks (2)
- 8— DC Power Supply Input Jack
- 9— Docking Station Connector
- 10— Battery Pack
- 11— Collapsible Stand

Figure 2-2

Technical Specifications

Item	Description / Specification
Touch Screen	Capacitive Touch Panel
Display	10.1 inch diagonal, TFT Color LCD
	1280 x 800 resolution (WXGA)
Processor	Intel Quad Core N2930, 1.8GHz
Operating System	Microsoft® Windows® Embedded 7
Communications	Wi-Fi standard (802.11 b/g/n)
	Bluetooth® 2.1 Technology
Battery	Rechargeable Lithium Ion Smart Battery Pack, 11.1VDC
	Approximate 5 hour run time
	Approximate 3.5 hour charge time
Power Supply	Supply Rating; 19 VDC, 3.4A
DC Operating Voltage	10 to 32 VDC
Width	12.4 in. (316 mm)
Height	8.23 in. (209 mm)
Depth	2.0 in. (51 mm)
Weight (including battery pack without Scope Multimeter Module)	3.80 lb (1.73 kg)
Weight (including battery pack and Scope Multimeter Module)	4.40 lb (2.00 kg)
Operating Temperature Range (ambient)	At 0 to 90% relative humidity (non-condensing) 32 to 113°F (0 to 45°C)
Storage Temperature (ambient)	At 0 to 70% relative humidity (non-condensing) -4 to 140°F (-20 to 60°C)
Operating Altitude	Maximum 2000 m
Environmental Conditions	This product is intended for indoor use only
	This product is rated for Pollution Degree 2 (normal conditions)

Built-in Stand

The built-in stand extends from the back of the Diagnostic Tool to allow hands-free viewing. The stand clips into the Diagnostic Tool for storage and pivots out so the display is at a 45 degree angle when in use.

Power Sources

Your Diagnostic Tool can receive power from any of the following sources:

- [Internal Battery Pack](#)
- [AC/DC Power Supply](#)
- [Vehicle Power](#)
- [Docking Station \(Optional\)](#)

Internal Battery Pack

The Diagnostic Tool can be powered from the internal rechargeable battery pack. A fully charged standard battery pack provides sufficient power for about 5 hours of continuous operation. The LED backlit power button indicates the battery status.

AC/DC Power Supply

The Diagnostic Tool can be powered from a standard AC outlet using the AC/DC power supply. When connected to the Diagnostic Tool, the AC/DC power supply also recharges the internal rechargeable battery pack.

Vehicle Power

The Diagnostic Tool can be powered from a standard 12VDC vehicle power port using the Diagnostic Tool DC power port adapter. The DC power port adapter connects to the DC power supply jack on the left side of the Diagnostic Tool.

Docking Station (Optional)

The Diagnostic Tool can be powered (when connected) by the optional docking station. When connected to the docking station, the internal rechargeable battery pack is recharged. Contact your sales representative for additional details.

2.1.2 Scope Module

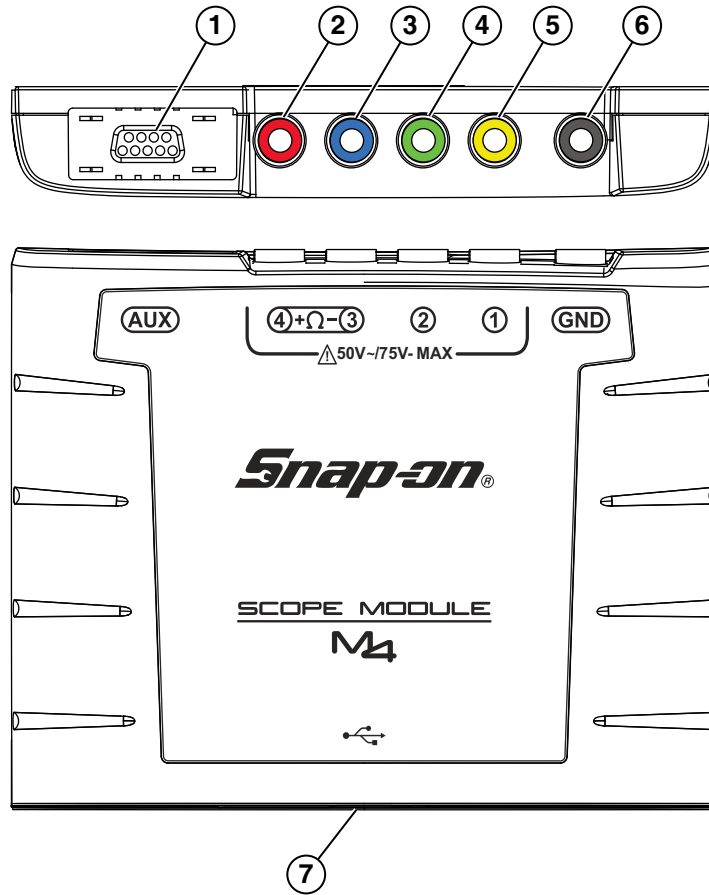

- 1— Auxiliary (DB9) Connector
- 2— Channel 4 Jack
- 3— Channel 3 Jack
- 4— Channel 2 Jack
- 5— Channel 1 Jack
- 6— Common (Ground) Jack
- 7— USB Jack (not shown - used for remote operation)

Figure 2-3 Scope Module, removed from Diagnostic Tool

Remote Operation

If needed, the Scope Module (M4) can be removed from the Diagnostic Tool, then connected to the Diagnostic Tool with a USB cable. This increases the range of mobility for the Diagnostic Tool while monitoring signals on the test vehicle. Use the Type A/B USB cable, which is provided with your kit, to make the connection. For additional information see, [Using the Scope Module Remotely](#) on page 97.

Technical Specifications

Item	Description / Specification
USB Power	5V @ 500mA
Agency Approval - Rating	IEC 61010-1, UL Listed 61010-1 - Category 1
Width	6.3 in. (160 mm)
Height	4.6 in. (118 mm)
Depth	1.1 in. (28 mm)
Weight	0.62 lb (0.28 kg)
Operating Temperature Range (ambient)	At 0 to 90% relative humidity (non-condensing) 32 to 113°F (0 to 45°C)
Storage Temperature (ambient)	At 0 to 70% relative humidity (non-condensing) -4 to 140°F (-20 to 60°C)
Operating Altitude	Maximum 2000 m
Environmental Conditions	This product is intended for indoor use only
	This product is rated for Pollution Degree 2 (normal conditions)

Power Sources

The Scope Module operates on USB power (5V @ 500mA) supplied by the Diagnostic Tool. Power is provided either through direct connection to the Diagnostic Tool, or through a USB cable when the Scope Module is removed from the Diagnostic Tool.

Auxiliary Connector

The auxiliary connector is used for connection of the optional RPM inductive pickup and the pressure transducer split lead adapter. For additional information contact your sales representative and see, [Using the Scope Module Remotely](#) on page 97.

2.1.3 Scan Module (Wireless)

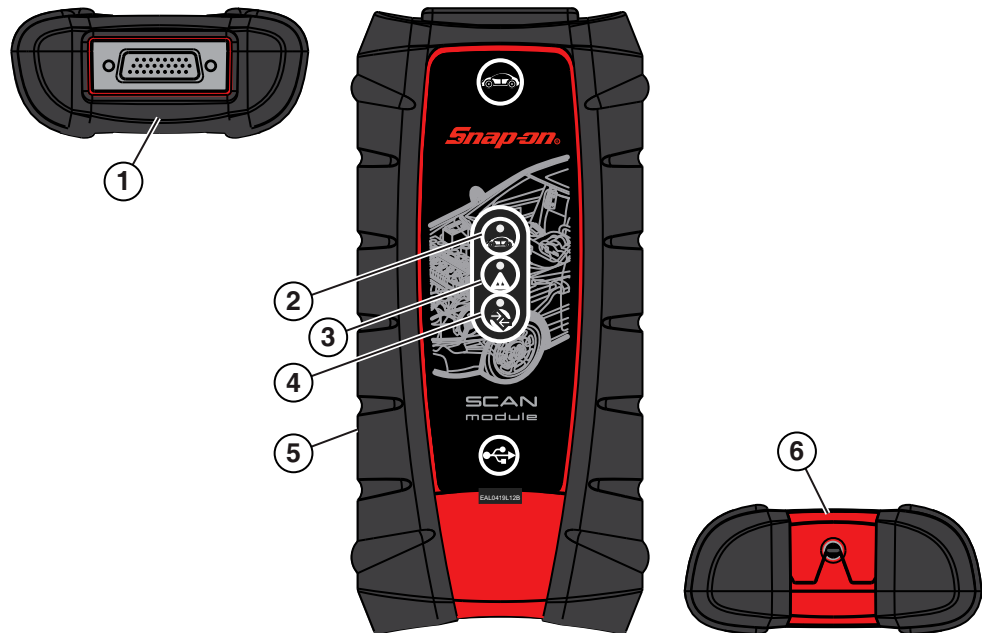

- 1— Data Cable Connector
- 2— Vehicle Power LED (green)
- 3— Communication Issue LED (red)
- 4— Bluetooth LED (green)
- 5— Memory Card Port (remove protective hand grip for access)
- 6— Universal Serial Bus (USB) Jack (remove protective hand grip for access)

Figure 2-4 Scan Module

Wireless Communication

The Scan Module is a wireless communications device that transmits vehicle data to the Diagnostic Tool without a physical connection. A signal lost due to moving out of range automatically restores itself when the Diagnostic Tool is brought closer to the Scan Module. The Scanner sounds a tone when the signal is lost.

Technical Specifications

Item	Description / Specification
Communications	Wireless <i>Bluetooth</i> [®] 2.1 Technology
USB Power	5V @ 500mA
Data Cable Connector Power	8V to 32V, Maximum 12 Watts
Width	8.04 in. (204.3 mm)
Height	3.82 in. (97 mm)
Depth	1.66 in. (42.1 mm)
Weight	0.9 lb (0.408 kg)
Operating Temperature Range (ambient)	At 0 to 90% relative humidity (non-condensing) 32 to 113°F (0 to 45°C)
Storage Temperature (ambient)	At 0 to 70% relative humidity (non-condensing) -4 to 140°F (-20 to 60°C)
Operating Altitude	Maximum 2000 m
Environmental Conditions	This product is intended for indoor use only
	This product is rated for Pollution Degree 2 (normal conditions)

Power Sources

The Scan Module operates on 12V or 24V vehicle power, which it receives through the data cable connector. The Scan Module powers on whenever it is connected to an OBD-II/EOBD compliant data link connector (DLC). For non OBD-II/EOBD compliant vehicles, the Scan Module can be powered from a suitable power port on the test vehicle using the auxiliary power cable supplied with your kit.

Basic Operation and Navigation

This chapter describes the basic operation, and navigation of the Diagnostic Tool.

3.1 Turning On/Off, Sleep Mode and Emergency Shutdown

The following sections describe how to turn the Diagnostic Tool on and off, use Sleep Mode and perform an emergency shutdown.

Before using the Diagnostic Tool, make sure the battery is fully charged or is connected to an AC/DC power supply. See [Power Sources](#) on page 6.

3.1.1 Turning On

Press and release the **Power** button ([Figure 2-1](#)) to switch the Diagnostic Tool on. The system boots up, then opens the Home screen ([Figure 3-6](#)).

Table 3-1 Power button

Name	Button	Description
Power Button / LED Indicator		Turns the Diagnostic Tool on. See LED Indicator on page 16 for LED indicator information.

3.1.2 Turning Off

IMPORTANT:

All vehicle communication must be terminated BEFORE turning off the Diagnostic Tool. A warning message displays if you attempt to turn the Diagnostic Tool off while communicating with the vehicle. Forcing a shut down while communicating may lead to ECM problems on some vehicles. Never disconnect the Data Cable when the Diagnostic Tool is communicating with the vehicle ECM.

Before turning the Diagnostic Tool off, it is highly recommended to back up personal and saved data to a USB mass storage device on a regular basis to prevent loss in the event of system corruption or hard disk drive failure.



To turn off the Diagnostic Tool:

1. Navigate to the Home screen.
2. Select the **Exit** icon.
3. From the Windows desktop, open the Windows **Start** menu.
4. Select **Turn Off Computer**.
5. Select **Turn Off** in the dialog box.

The open programs close and the power turns off.

3.1.3 Sleep Mode

The Windows operating system uses Sleep Mode to conserve power by stopping all processes and turning off the display screen, while keeping the diagnostic tool on and open applications active. When you are ready to resume work, the diagnostic tool can be started up again quickly, just by pressing the Power button.

Sleep Mode settings can be found in Windows **Control Panel > Power Options**. For additional information, refer to Windows 7 user documentation.

IMPORTANT:

It is recommended that you terminate any current vehicle communication and save any open working files or data **before** entering Sleep Mode, to avoid any vehicle ECM problems or data loss from any unforeseen circumstances (e.g. power loss).

**NOTE:**

If Sleep Mode is accidentally activated during active vehicle communication, vehicle communication will stop, and vehicle selection will be reset to “no active vehicle”.

**To enter Sleep Mode:**

- Press and release the **Power** button.

The display screen will turn off and the LED backlit power button will light up red, blinking on and off at two second intervals.

**To exit Sleep Mode (wake up):**

1. Press and release the **Power** button.

The display screen will turn on and resume the last open application. Depending on settings, you may need to select your user ID icon to open the last application.

3.1.4 Emergency Shutdown

IMPORTANT:

Using the emergency shutdown procedure while communicating with the vehicle ECM may lead to ECM problems on some vehicles.

During normal operation turn the Diagnostic Tool off using the *Turning Off* procedure above. The emergency shutdown procedure should only be used as the last option, if the Diagnostic Tool does not respond to navigation or control buttons or exhibits erratic operation.

To perform an emergency shutdown:

1. Press and release the **Power** button.

The display screen will turn off and the LED backlit power button will turn red and begin blinking.

2. Press and hold the **Power** button again, until the LED in the power button stops blinking.

3.2 Shortcut (S) Button

The shortcut (S) button (Figure 3-1) located on the front of the diagnostic tool, and is a customizable button that can be set to perform various routine functions.



Figure 3-1



NOTE:

You can open the Shortcut menu at anytime by pressing and holding the Shortcut (S) button for 3 seconds.

Pressing the shortcut button (Figure 2-1) (when set to open the shortcut menu), opens a slide-out menu which provides the following selectable icon options:.

Table 3-2

Name	Icon	Description
Screen Capture		Saves a bitmap image (screenshot) of the visible screen. For file retrieval and management information, see Data Manager Operations on page 132.
Camera		Opens the camera application. See Camera Operation on page 24 for additional information.
Keyboard		Opens the virtual keyboard. See Virtual Keyboard on page 22 for additional information.
Brightness		Pressing and releasing the Brightness icon changes the display brightness setting. Use multiple taps to toggle though the settings.
Settings		Opens the Shortcut (S) button configuration menu.

3.2.1 Configure Shortcut (S) Button

This feature allows you to change the function of the **Shortcut (S)** button.



To configure the Shortcut (S) button:

1. Press and release the **Shortcut (S)** button.
2. Select the **Settings** icon from the slide-out menu.
3. Choose the function you would like the Shortcut button to perform when pressed ([Figure 3-2](#)).
The current/active setting is indicated by a yellow highlight box.

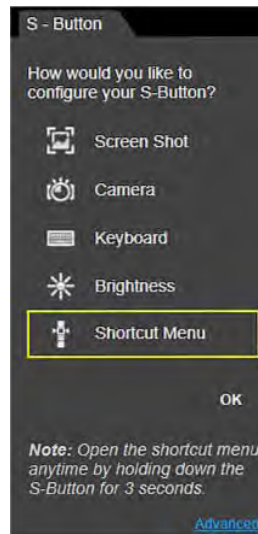

Figure 3-2 Shortcut (S) button configuration menu

4. Select **OK**.

3.2.2 Advanced (menu selection)

The Advanced selection has no functionality under normal operating conditions, and should **ONLY** be selected when directed to do so, by Snap-on customer service.

Selecting **Advanced** displays the advanced diagnostic system information screen. The system state information and functions are **ONLY** used during system troubleshooting, when requested by Snap-on customer service.

3.3 Changing the Units of Measurement

The Diagnostic Suite units of measurement can be changed for temperature, vehicle speed, air pressure and other pressure readings. Choose between US customary or metric units of measure.



To change the units of measurement:

1. Select **Scanner**..
2. Select the **Menu** icon from the lower toolbar.
3. Select **Tools > Units Setup**..

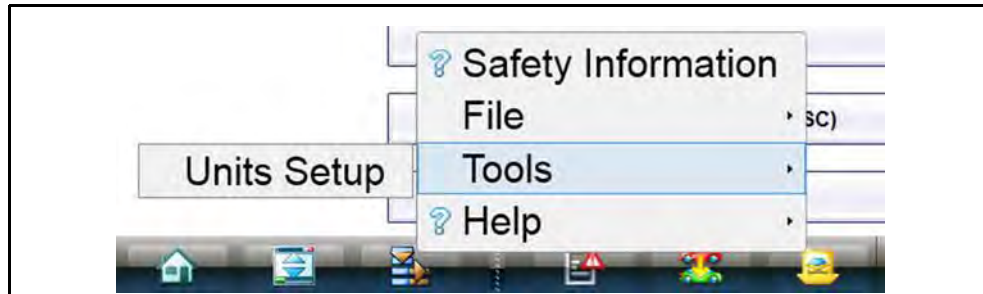

Figure 3-3 Menu icon

The Units setup dialog box opens.

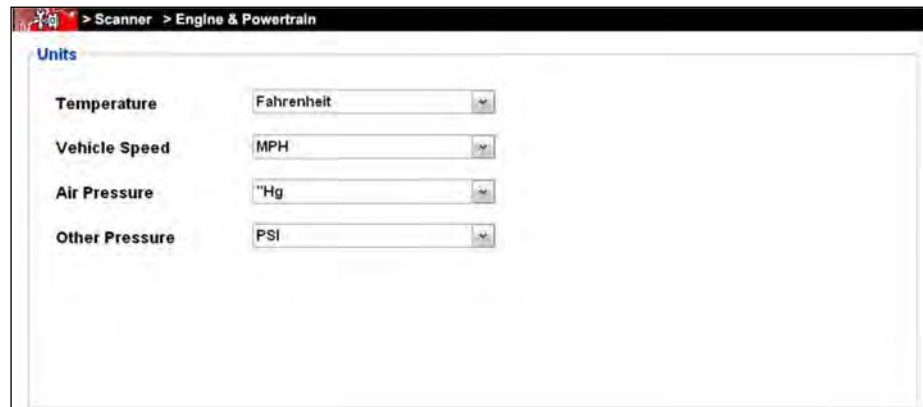



Figure 3-4 Units Setup screen

4. Use the dropdown menus to select the desired value for each item.
5. Select **Accept** to close the dialog box and apply the changes.

3.4 LED Indicator

The power button is backlit by an light emitting diode (LED) (see [Figure 2-1 on page 3](#) for location). The LED is used to indicate battery/power status and sleep mode activation.

Table 3-3

Name	Button
Power Button / LED Indicator	

- Battery Status Indicator LED—three colors are used to show the battery and power status:
 - **Green** indicates either a battery with a full or nearly full charge, or the Diagnostic Tool is being powered by the AC/DC Power Supply.
 - **Orange** indicates a battery that is charging.
 - **Red** indicates a low battery (15% of capacity or less).
- Sleep Mode:
 - A **Red** LED that blinks on and off at two second intervals indicates the Diagnostic Tool is in Sleep Mode. See [Sleep Mode](#) on page 12 for additional information.

3.5 Basic Navigation

3.5.1 Touch Screen and Stylus

The capacitive touch screen is used to control almost all the operations of the Diagnostic Tool. Simply touch the screen with your finger, or use the capacitive stylus to make a selection. The capacitive touch screen also provides you with multi-touch gesture capabilities found on common surface touch devices. Most operations are menu driven, which allows you to quickly locate the test, procedure, or data that you need through a series of choices and questions. Detailed descriptions of the menu structures are found in the chapters for the various functions.

For information on touch screen calibration, maintenance and stylus tip replacement:

Touch screen calibration - see [Calibrating the Touch Screen](#) on page 180

Touch screen maintenance - see [Cleaning the Touch Screen](#) on page 176

Stylus tip replacement - see [Stylus Tip Replacement](#) on page 183

Touch Screen Gestures

This device uses common touch screen gesture motions (e.g. pinch-to-zoom, press and tap, pan and swipe). The terms used to describe the various gestures may vary (industry wide), however the general procedures and usage are similar for specific operations.

Table 3-4

Common Gesture Names	General Procedure	Common Usage
Tap Touch Select	Quickly tap a point (once), then release. Quickly tap a point (twice).	Make a selection (e.g. open application) Insert a cursor in a text string Open alternate menus.
Pinch open/close Pinch-to-zoom Zoom	Touch two points, then move your fingers toward or away from each other.	Zoom the display in or out, to make a selection (e.g. image or picture) larger or smaller.
Touch and hold Select and hold Tap and hold	Touch a point and maintain light pressure.	Make a selection Insert a cursor in a text string Open alternate menus.
Touch and drag Select and drag Tap and drag Pan	Touch a point, then while maintaining light pressure, drag in the desired direction.	Move onscreen controls (e.g. scrollbars and slidebars) Move windows Select text
Swipe Flick	In a quick and continuous motion, select a point and quickly swipe in the desired direction while lifting off the screen.	Quickly scroll or move through content Open alternate menus.
Press and tap Select and tap	Touch a point, then while maintaining light pressure, tap (in the same general area) with another finger.	Open alternate menus (similar to right click).

The information provided in the above table is not inclusive, may vary and is intended as a general guide only. For additional information on Windows touch screen operations, see Windows 7 and Windows “*touch gesture*” user documentation. Also refer to *Pen and Touch* settings in the Windows *Control Panel* for additional information and settings.

3.5.2 Starting the ShopStream Diagnostic Suite Program

The ShopStream Diagnostic Suite program is the main program which is used for all diagnostic functions. The ShopStream Diagnostic Suite program is automatically started when the Diagnostic Tool is turned on through the Windows “start up” folder function. After the program has started, the ShopStream Diagnostic Suite Home Screen displays, see [Home Screen Layout](#) on page 18. The application runs as a normal Windows program and it’s window can be minimized, resized and closed like any other Windows program. To access the Windows desktop, minimize the program window.

If the program is exited or closed, select the ShopStream Diagnostic Suite icon from the Windows desktop to start the program.



Figure 3-5 ShopStream Diagnostic Suite desktop icon



NOTE:

The ShopStream Diagnostic Suite can also be started from the Windows Start menu.

3.5.3 Home Screen Layout

The Home screen includes the diagnostic suite toolbar and the Windows taskbar. The Home screen includes function icons, one for each of the primary Diagnostic Tool functions.











1. **Function Icons**
2. **Toolbar**
3. **Windows Taskbar**
4. **Windows Taskbar Notification Area**

Figure 3-6 Home screen

3.5.4 Function Icons

The Function Icons configure the Diagnostic Tool for the type of test to be performed. [Table 3-5](#) on page 19 gives brief descriptions of the available icons, which operations are available depends upon the individual configuration of your system. Use the stylus or your finger tip to select from the icons.







Table 3-5

Name	Icon	Description
Scanner		Configures the Diagnostic Tool to operate as a scan tool. See Scanner Function on page 32.
OBD Direct		Allows you to perform generic OBD-II or EOBD system tests without identifying the specific vehicle. See OBD Direct Operations on page 78.
Guided Component Test		Opens a diagnostic database of specific tests for the identified vehicle. See Guided Component Test Operations on page 86.
Scope Multimeter		Configures the Diagnostic Tool to operate as a lab scope, graphing multimeter, or digital multimeter. See Scope and Multimeter Operations on page 97.
Vehicle History		Identifies the test vehicle and organizes and manages work in progress and service records. See Vehicle History Operations on page 126.
Data Manager		Opens the organization system for saved data files. See Data Manager Operations on page 132.
Help		Opens the on-line help for the system. See Help Operations on page 158.
System Settings		Establishes and manages connections to peripheral devices, such as the Scan Module. See System Settings Operations on page 159.
Exit		Closes the Diagnostic Tool software and returns the display to the Windows desktop. See Turning Off on page 11.

3.5.5 Toolbar

Operation of the icons located on the toolbar are described in the table below:

Table 3-6

Name	Icon	Description
Home		Selecting this icon returns you to the Home screen from any test.
Desktop		Selecting this icon toggles the Windows taskbar on/off at the bottom of the screen, and allows you access to the Windows desktop.
Menu		Selecting this icon opens a menu that provides information and basic operations and features for the current screen.
Change Vehicle		The currently identified vehicle is shown to the right of the icons, selecting allows you to change the identified test vehicle.
View Record		Selecting the icon opens an editable worksheet of vehicle records.
Hardware Status		Indicates the connectivity status of the Scan Module. Icon changes depending on status.
		Indicates the connectivity status of the Scope Multimeter. Icon changes depending on status.

Menu Options

The Menu icon on the Toolbar at the base of the display screen opens a list of basic operations and features. The list of options varies depending upon which module, or tool function, is active. Selecting a menu item opens a submenu of choices, and some submenus also open an additional menu. A right arrowhead (▶) indicates additional choices are available. Touch an item to select it. The following Menu options are available from the Home Screen:

- [Safety Information](#)—opens the *Important Safety Instructions* document.
- [Help](#)—allows you to view supporting documentation, selecting opens a submenu.

Safety Information

Selecting **Safety Information** opens a PDF copy of the *Important Safety Instructions* that are included in your Diagnostic Tool kit. The *Important Safety Instructions* document should be read and understood prior to using the Diagnostic Tool.

Help

A variety of utilities and additional resources are available through the Help menu. Basic menu options, which are available for all modules, include:

- [User Manual](#)
- [Version Info](#)
- [Activation Status](#)

User Manual

This option opens this document, which provides overall navigation and operation information for the Diagnostic Tool.

Version Info

This option opens a window showing the version of the software and a copy of the Software License Agreement. Select **OK** to close the window.

Activation Status

This option opens a dialog box with version and licensing details for the system, and activation status for the Diagnostic Tool and all other modules.

3.5.6 Windows Taskbar

The standard Windows taskbar displays program icons that are currently running or that you have pinned to the taskbar for quick access. Refer to Microsoft Windows 7 user documentation for additional information.

Windows Taskbar Notification Area

The notification area contains icons that provide active status and notifications of selected programs. The notification area may contain standard Windows application icons (e.g. Wireless Network Connection Status, Audio volume, etc) and specialized application icons designed for use only on this Diagnostic Tool (e.g. ShopStream Update Tool and Virtual Keyboard). Refer to Windows 7 user documentation for additional information for Windows applications. For additional information on the ShopStream Update Tool and Virtual Keyboard, see:

ShopStream Update Tool - [ShopStream Update Tool \(SST\)](#) on page 168

Virtual Keyboard - [Virtual Keyboard](#) on page 22

3.6 Virtual Keyboard

The Windows Touch Keyboard (Virtual Keyboard) allows you to type characters and key in information to complete form and data entry fields, similar to a physical keyboard.

The virtual keyboard is normally running in the Windows background and can be opened in the following ways:

- **Shortcut (S) button** - choose the **Virtual Keyboard** icon from the Shortcut (S) button menu
- **Windows notification area** - choose the **Virtual Keyboard** icon in the Windows notification area
- **Docking area** - By default the virtual keyboard is docked (auto-hide) to the left side of the screen. To access the virtual keyboard, swipe from the left edge of the screen to right (centered top to bottom). A tab will appear on the edge of the screen. Swipe the tab again left to right and the virtual keyboard will display.



NOTE:

As an alternative, you can connect a USB keyboard to the Diagnostic Tool and use it to key in information.



Figure 3-7 Virtual Keyboard icon in notification area

To customize settings and find additional operational information, select **Tools** (Figure 3-8) to open a dropdown menu to access optional settings and Help links.



Figure 3-8 Tools menu

To learn more about the virtual keyboard, select **Help Topics** from the Tools menu to open the Windows Touch Keyboard help and support (Figure 3-9).

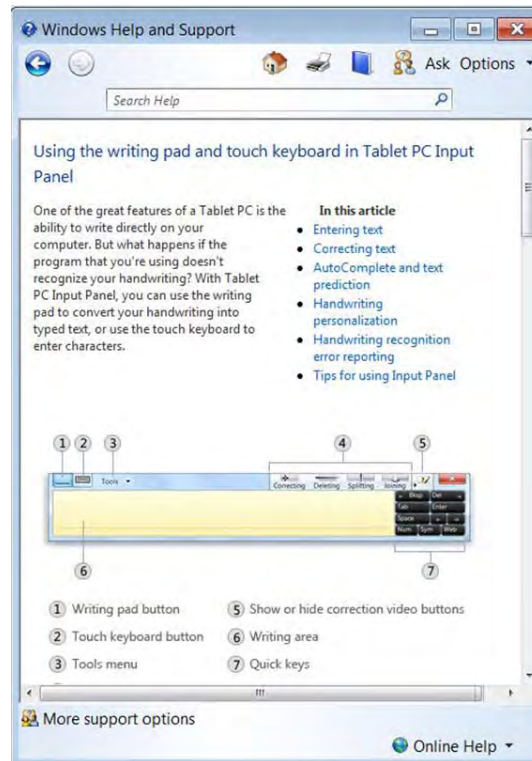









Figure 3-9 Help window

3.7 Camera Operation

3.7.1 Operating the Camera

Selecting **Camera** from the shortcut (S) button menu opens the camera application. The touch screen becomes the view finder and is also used for reviewing photographs that are taken. Icons on the touch screen are used to operate the camera. The icons change depending on which camera function is active:

Table 3-7 *Camera icons*

Name	Icon	Description
Photo		Acts as a shutter to take a photograph of what is visible in the view finder, which is the left-hand portion of the screen.
Gallery		Opens a thumbnail gallery of recently taken pictures.
Exit		Closes the camera application and returns to the previous screen.
Save		Displays after a picture is taken. Selecting saves the photograph and returns to the view finder.
Delete		Displays after a picture is taken and in Gallery mode. Selecting discards the photograph and returns to the previous screen.
Back		Displays in Gallery mode. Selecting returns to the previously viewed screen.
Previous		Displays in Gallery mode. Selecting opens the picture prior to the current image in the gallery.
Next		Displays in Gallery mode. Selecting opens the picture after the current image in the gallery.

**Taking pictures:**

1. Press the **Shortcut (S) Button** and choose **Camera** from the menu.
2. Focus the image to be captured in the view finder.
3. Press the **Photo** icon.
The view finder now shows the captured picture.
4. Select **Save** to save the image, or **Delete** to delete it.
5. Select **Exit** from the live view to close the camera application.

3.7.2 Viewing Pictures

Photographs are stored on the hard drive and can be retrieved two ways:

From the Diagnostic Suite; select **Data Manager** from the Home screen, then open the **Camera Folder**.

From the desktop; select **My Documents > ShopStream > Camera Folder**.

3.8 Wi-Fi Setup

The diagnostic tool uses Windows[®] 7 embedded system software. Wi-Fi connection is controlled through the Windows operating system.

The Wi-Fi connection instructions shown here are intended for quick reference only. For Wi-Fi related instructions / troubleshooting that are outside the scope of these instructions, visit Windows online support.

Wi-Fi connection allows you to:

- Access the Internet using the Windows web browser.
- Use built-in ShopStream Diagnostic Suite Repair Information applications (e.g. SureTrack[®], Tire and Wheel Service, TSBs, Oil Specs and Resets, etc). **Note:** *Repair Information applications are not available on all models, are optional and vary by model.*
- Receive diagnostic software updates
- Receive important product messages.

Connecting to Wi-Fi

**NOTE:**

Whenever the diagnostic tool is turned on, Wi-Fi will automatically try to connect to a network.

1. Turn on the diagnostic tool and allow Windows to bootup, then allow the ShopStream Diagnostic Suite software to open.

After bootup if Wi-Fi is not automatically connected you will notice the Wi-Fi icon in the System Tray (lower right side) is gray with an amber colored star (this indicates Wi-Fi is not connected (shown below)).

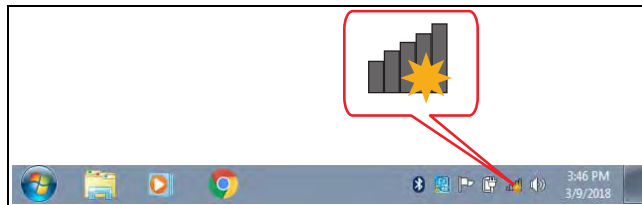

2. To connect to a network, click the Wi-Fi icon in the System Tray. The wireless network connection window opens (shown below).

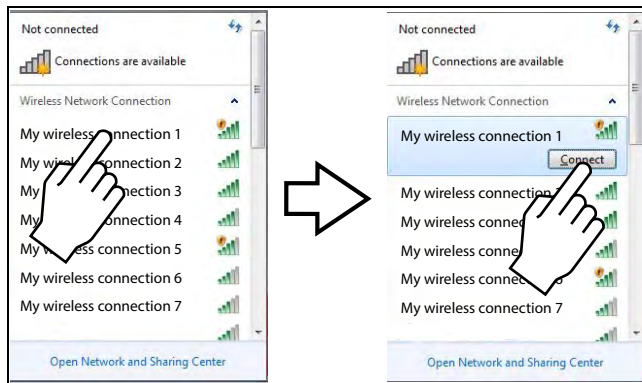

3. Choose your **Wireless Network** from the list of available networks, then select **Connect**.



NOTE: A password is required when choosing a protected network.

A wireless network connection progress window displays as the connection is being made.

4. After the connection is successfully made, the Wi-Fi icon in the System Tray will display as Connected (shown below).

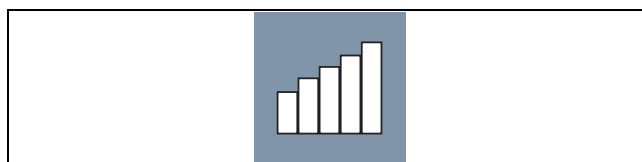

The diagnostic tool is now connected to the Wi-Fi network.



NOTE: Wi-Fi performance varies depending on your wireless network equipment and ISP.

3.9 Printing / Printer Setup

Selecting **Print** opens a standard Windows Print dialog box.

To print, a printer must be installed and set as the system default printer. The following sections provide basic instructions for local printer setup.

**NOTE:**

The factory default printer setting is (.XPS file format). From the standard Windows print dialog box, you can name the file and specify the location that it is saved to. The file can then be viewed onscreen using the Windows XPS Viewer.

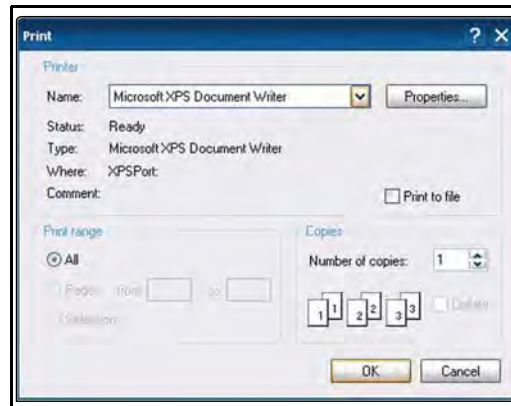

Figure 3-10 Typical Print dialog box

**NOTE:**

To print a code scan Vehicle System Report, Adobe Reader must first be installed. See [Checking/Installing Adobe® Reader](#) on page 31.

The following is intended as a basic printer setup instruction only. Printer setup will vary. For specific instructions and details, refer to your printer setup information and the online Windows printer setup help information.

There are three basic methods to connect a printer to the diagnostic tool, using a USB cable, connecting over a Wireless Network and Direct Wireless connection. Basic connection instructions are provided in the following sections.

3.9.1 USB Printer Setup

1. Turn the printer on.
2. Connect the USB cable from the printer to the diagnostic tool.
3. Windows should automatically detect and install the printer.
4. Follow the onscreen instructions to install the printer and then set the printer as the default printer. See [Default Printer Setting](#) on page 30.

If the printer driver files are not automatically installed, you will have to manually install the printer driver files. Printer driver files may be supplied with the printer (e.g. CD or memory stick), or check the printer manufacturer's website to download the files. Follow the manufacturer's instructions for driver installation.

3.9.2 Wireless Printer Setup

If your printer is Wi-Fi enabled, you may have options to connect the diagnostic tool to the printer using an existing Wi-Fi network (through a router), or connect directly to the printer wirelessly.

Connecting to an existing Wi-Fi network is the most common method, as this allows you to connect to the printer and stay connected to the Internet (if applicable).



NOTE:

You may only connect to one network, therefore when connecting directly to your wireless printer, any other active wireless connection will be disconnected.

Wi-Fi Network Connection

Use the following instructions (as a guide) if you choose to connect the diagnostic tool to the printer through your existing network.

1. Turn your printer on and make sure it is setup per the manufacturers instructions.
2. Connect the printer to your wireless network. A password may be required when connecting to a protected network. Note the printer connection IP address when it connects to the network.
3. From the diagnostic tool, select the **Windows** icon on the desktop (lower left).
4. Select **Devices and Printers** (right-side menu).
5. Select **Add a Printer** from the toolbar.
6. Select **Add Network, Wireless or Bluetooth Printer**.
7. Follow the onscreen instructions to search, locate and install your printer. Windows automatically searches for available printers on the network (Figure 3-11).

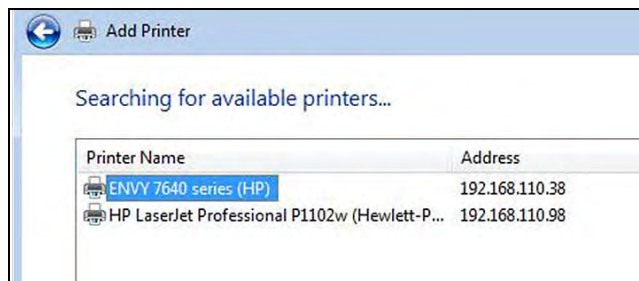

Figure 3-11

**NOTE:**

If other devices are discovered on the network, connect to the printer with the matching IP address from step 2.

It is important that you install the printer driver files when prompted, during setup. Printer driver files may be supplied with the printer (e.g. CD or memory stick), or check the printer manufacturer's website to download the files.

8. Set the printer as the default printer. See [Default Printer Setting](#) on page 30.

Direct Wi-Fi Connection

Use the following instructions (as a guide) if your printer supports direct connection, and you choose to connect the diagnostic tool directly to the printer.

1. Turn your printer on and make sure it is setup per the manufacturers instructions for direct connection. The printer must be able to be wirelessly detected by the diagnostic tool.



NOTE:

You can only connect to one network, therefore when connecting to your wireless printer, any other active wireless connection will be disconnected.

2. From the diagnostic tool, click the Wi-Fi icon in the System Tray (Figure 3-12).

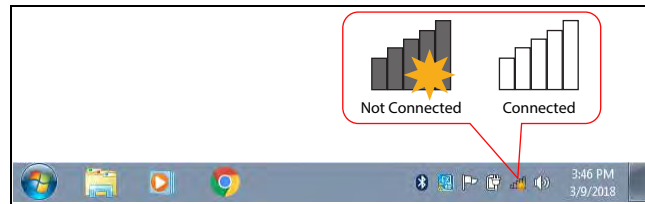

Figure 3-12

3. Choose your **Wireless Printer** from the list of available networks, then select **Connect** (Figure 3-13).

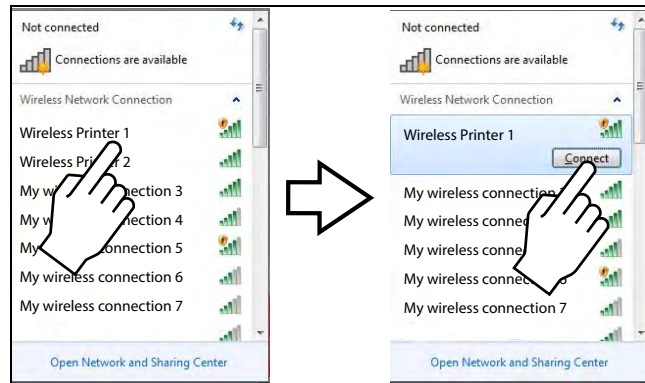

Figure 3-13

4. Enter the security password for your wireless printer. See your printer documentation for details.

A wireless network connection progress window displays as the connection is being made.

Once the diagnostic tool is connected to the Wi-Fi printer, follow these steps to install the printer:

5. Select the **Windows** icon on the desktop (lower left).
6. Select **Devices and Printers** (right-side menu).
7. Select **Add a Printer** from the toolbar.
8. Select **Add Network, Wireless or Bluetooth Printer**.
9. Follow the onscreen instructions to search, locate and install your printer. Windows automatically searches for available printers on the network (Figure 3-11).

It is important that you install the printer driver files when prompted, during setup. Printer driver files may be supplied with the printer (e.g. CD or memory stick), or check the printer manufacturer's website to download the files.

10. Set the printer as the default printer. See [Default Printer Setting](#) on page 30.

3.9.3 Default Printer Setting

To set a default system printer:

1. Select the **Windows** icon on the desktop (lower left).
2. Select **Devices and Printers** (right-side menu).
3. Touch and hold the icon of the printer you want to set as the default, until the optional menu indicator (circle outline) appears ([Figure 3-14](#)) and then release (this is also known as right-click menu). From the menu, select "**Set as default printer**". When set, a check mark is displayed next to the option ([Figure 3-14](#)).

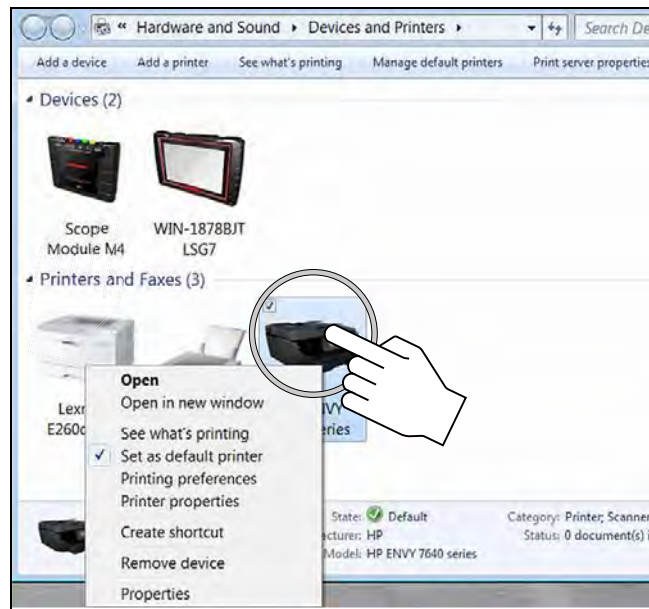

Figure 3-14



NOTE:

The printer right-click menu, also provides access to other printer settings such as properties and preferences.

3.9.4 Checking/Installing Adobe® Reader

To print the Vehicle System Report, Adobe Reader must be installed.

To check if you have Adobe Reader installed:

1. Check if the Adobe Reader shortcut icon is on the desktop, or
2. Select the Windows icon on the desktop (lower left).
3. Select **All Programs** from the menu.

Adobe Reader should appear near the top of the list (depending on what other software you have installed).

To install Adobe Reader:

1. Visit: adobe.com, or get.adobe.com/reader/
2. Follow the instructions to download and install the free version of Adobe Reader for Windows.



NOTE:

Deselect any options such as “Install Acrobat Reader Chrome Extension”, or install optional security, etc. Only Adobe Reader is needed.

The Scanner function allows your Diagnostic Tool to communicate with the electronic control modules (ECMs) of the vehicle being serviced. This allows you to perform tests, view diagnostic trouble codes (DTCs), and view live data parameters from various vehicle systems such as the engine, transmission, antilock brake system (ABS) and more.

4.1 Demonstration Program

A Scanner demonstration program is provided to help you to become familiar with Scanner operations, without connecting to a vehicle. Sample data and test results are provided to help you learn the menus and basic operations.

IMPORTANT:

Do not connect the Scan Module to a vehicle while using the Demonstration mode.



Using the demonstration program:

1. From the Home screen, select the **Scanner** icon to open the manufacturer menu. The manufacturer menu includes all makes for which Scanner information is available. There is also a Demonstration icon included in the list.

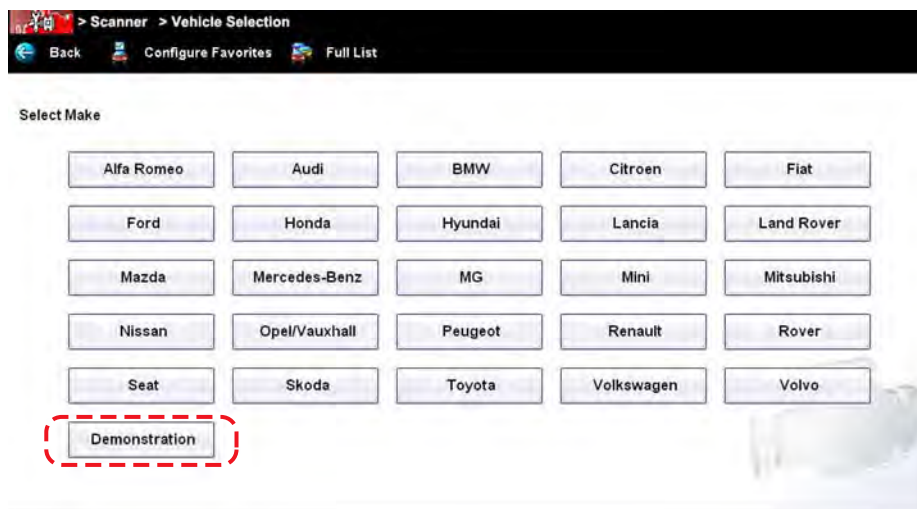

Figure 4-1 Sample demonstration selection

2. Select the **Demonstration** icon.
A menu of demonstration choices displays:
 - Demonstration Vehicle—contains actual data from a selected vehicle to simulate parameter outputs.
 - OBD Training Mode—provides simulated data for an OBD-II/EOBD vehicle that allows you to access any of the standard functions.
3. Select either option and a confirmation message displays.
4. Select **OK** to load the selected database.
5. Follow the on-screen instructions and select as needed until the Systems menu displays.
6. Select from any of the systems listed, then select from the submenus.

4.2 Basic Operation and Navigation

This section describes the basic menus, controls and navigation of the Scanner function and select scanner tests.

4.2.1 Screen Messages

Screen messages appear when additional input is needed before proceeding. There are three types of on-screen messages; confirmations, warnings, and errors.

- **Confirmation Messages** - Confirmation messages inform you when you are about to perform an action that cannot be reversed or when an action has been initiated and your confirmation is needed to continue. When a user-response is not required to continue, the message displays briefly before automatically disappearing.
- **Warning Messages** - Warning messages inform you when completing the selected action may result in an irreversible change or loss of data.
- **Error Messages** - Error messages inform you when a system or procedural error has occurred. Examples of possible errors include a disconnected cable or a peripheral, such as a printer, is powered off.

4.2.2 Making Selections

The Scanner interface is a menu driven program that presents a series of choices one at a time. As you select from a menu, the next menu in the series displays. Each selection narrows the focus and leads to the desired test. Use your fingertip or the stylus to make menu selections.

4.2.3 Scanner Screen Layout

The Scanner screens typically include three sections (Figure 4-2):

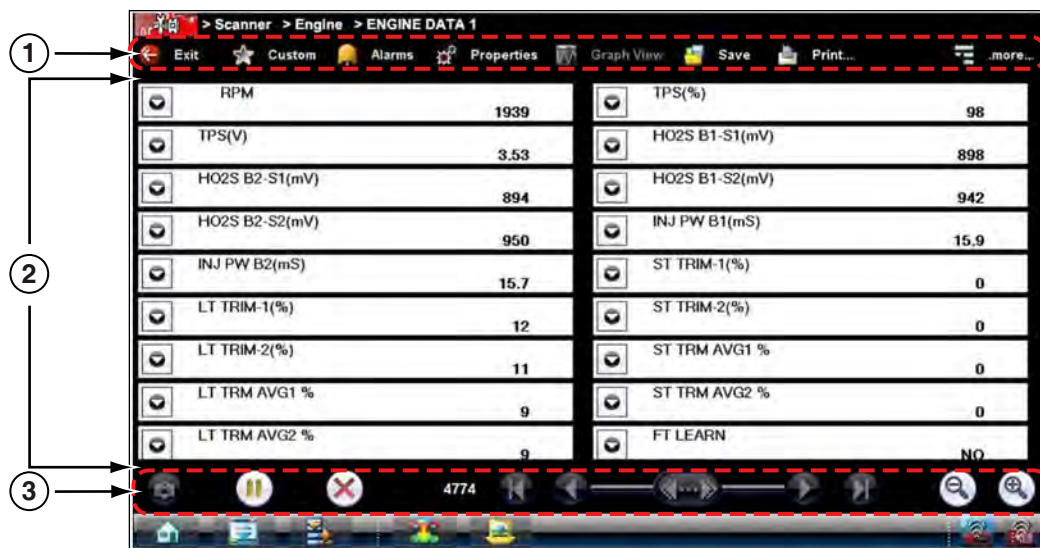

- 1— Scanner Toolbar
- 2— Main Body
- 3— Lower Toolbar

Figure 4-2 Scanner screen layout





Scanner Toolbar

The Scanner toolbar contains a number of icons that allow you to configure the displayed data and to exit. The table below provides a brief explanation of the Scanner toolbar icon operations:

Table 4-1 Scanner toolbar icons (sheet 1 of 2)

Name	Icon	Description
Exit		Closes the current test and returns you to the menu.
Back		When available, returns to the previously viewed screen.
Custom		Allows you to select which parameters are displayed on the screen.
Alarms		Allows you to set an alarm on certain data parameters when the signal goes above or below the alarm setting.
Properties		Allows you to adjust the display characteristics for all of the data screens.
Graph View		Allows you to simultaneously view up to 16 data graphs at a time.

Table 4-1 Scanner toolbar icons (sheet 2 of 2)

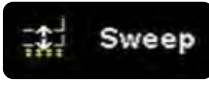
Name	Icon	Description
Save		Saves a copy of the current frame of data that can be viewed using Data Manager.
Print		Opens a standard Windows Print dialog box for saving a print copy of the current frame of data. See Printing / Printer Setup on page 27.
More		Opens a dropdown menu of the additional options shown below.
Scale		Switches the scale values, displayed along the left-hand side of the graphs, on and off.
Sweep		Switches the sweep values, displayed at the base of the graphs, on and off.

The Scanner toolbar is used to configure certain aspects of the displayed data and to exit. The following sections explain how to use the toolbar.

Custom

The **Custom** icon on the Scanner Toolbar is used to determine which specific parameters display. Minimizing the number of parameters on the data list allows you to focus on any suspicious or symptom-specific data parameters. You can add or remove most parameters from the list. Any parameter that has a lock icon next to it cannot be removed from the list.

IMPORTANT:

Limiting the number of parameters that display allows for a faster refresh rate of the data. A smaller data list also reduces the amount of memory used for saved files.



To create a custom data list:

1. Select **Custom** on the Scanner Toolbar.
The parameter selection dialog box with all of the parameters selected opens ([Figure 4-3](#)).
2. Select the **Deselect All** icon to clear the highlights from the screen.
3. Create a custom data list by selecting the parameters to be included. Highlighting indicates a parameter that displays, parameters that are not highlighted do not display.

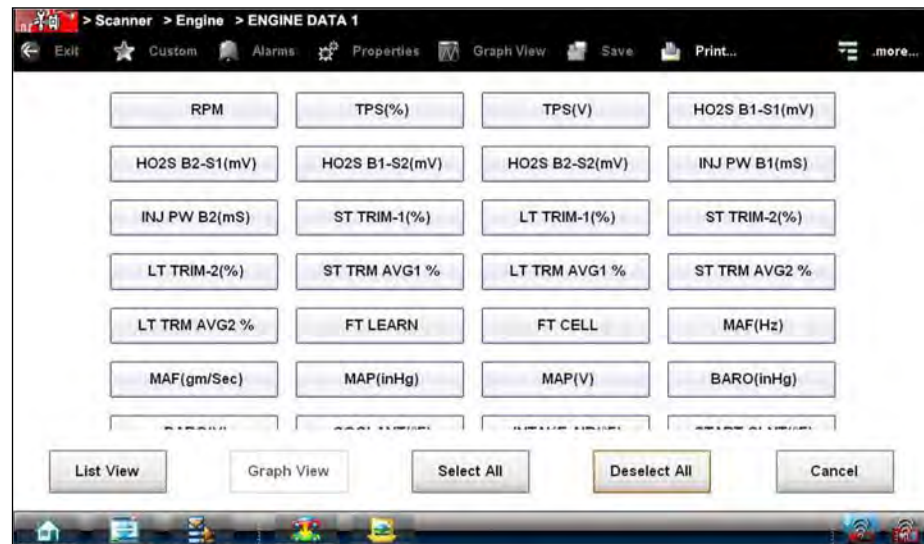

Figure 4-3 Sample custom configuration screen

Keep the following in mind when configuring a custom data list:

- Gesture scroll if the list of parameters is longer than what is shown on the screen.
 - Use the **Select All** icon to display the complete list.
 - Use the **Deselect All** icon to remove all the currently selected parameters from the list.
 - Select individual parameters to highlight and include them in the list.
 - Select individual highlighted parameters to remove them from the list.
 - Use the **Cancel** icon to return to the data display.
4. Once all desired parameters have been selected, return to the data list:
- Use the **List View** icon to return to a data screen in PID List format.
 - Use the **Graph View** icon to return to a data screen in Graph View format, see [Graph View](#) on page 38 for details.



NOTE:

Graph View is only available when 16 or fewer parameters (the number that can display on a single screen) were selected for the custom list. Make sure that no more than 16 parameters are highlighted if the screen displays a single graph when the Graph View icon is selected.

Alarms

Alarms are visual indicators alongside a parameter in the data display list that change color to show the signal status. A green alarm indicates on, a gray alarm indicates off. Only digital parameters, those with a range limited to two states, can have alarms. Parameters with continuous ranges, such as variable voltage and pressure values, cannot have alarms. The alarm indicator assignments remain as selected until you exit the data list:



To configure alarm settings:

1. Select the **Alarms** icon on the Scanner Toolbar.
The Alarm List dialog box opens.
2. Check the parameters that you want to show alarms.
3. Select **Save**.

Alarm indicators now appear next to the selected parameters in the Data List (Figure 4-4).

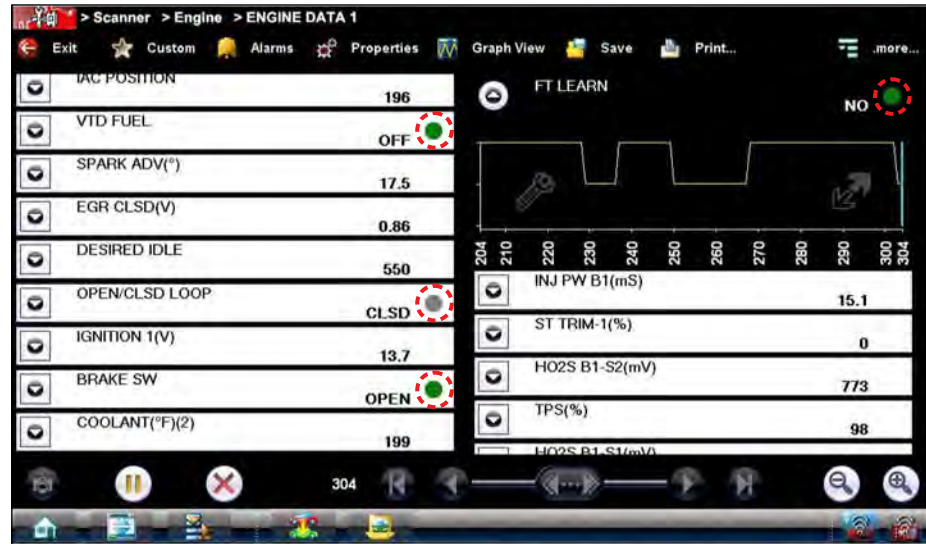

Figure 4-4 Sample alarm indicators



NOTE:

Alarms can only be set for certain parameters. If the Alarm List dialog box is empty, no parameters are available and alarms cannot be set.

Properties

The **Properties** icon on the Scanner Toolbar is used to configure certain characteristics of the parameter graph display. Selecting opens a Properties dialog box that allows you to adjust colors, settings, and sweep (Figure 4-5).

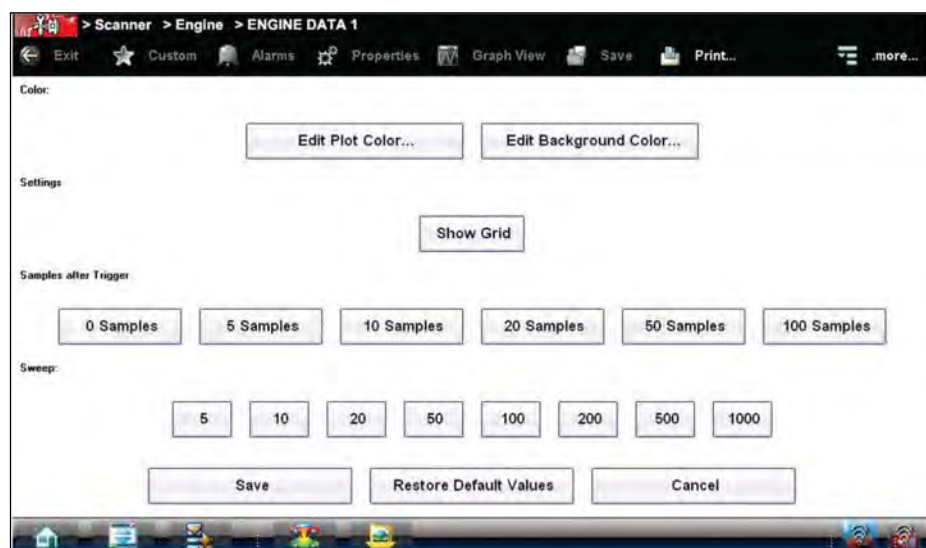

Figure 4-5 Sample properties dialog box

Selecting either color option, **Edit Plot Color** or **Edit Background Color** opens a standard color selection dialog box. Select a color, then select **OK** to close the dialog box.

The Show Grid icon is used to switch a background grid pattern on the data graphs on and off:

- To switch the grid on; select to highlight **Show Grid**, then select **Accept**.
- To switch the grid off; select **Show Grid** twice so it is not highlighted, then select **Accept**.

The Samples After Trigger setting determines how many data samples are recorded following a triggering event. The highlighted samples icon indicates the number of frames that are included in the recording after a triggering event.

The sweep options let you choose the amount of data that displays across the graph. Values are in sample points, or frames of data. A frame of data equals one complete transmission of the serial data by the electronic control module.

Graph View

Graph View allows you to simultaneously display up to 16 parameter graphs (Figure 4-6). The graphs must first be opened in the data list in order to be included when **Graph View** is selected from the toolbar. The display defaults to a single graph if more than 16 graphs are open when the toolbar icon is selected. Should this happen, return to the data list and close some of the graphs.

A toolbar in Graph View allows you switch scale and sweep values on and off, and to return to the List View. The Data Buffer toolbar at the base of the screen remains active.



NOTE:

The screen does not scroll in Graph View mode, it adjusts to show only the selected parameters.



Figure 4-6 Sample Graph View screen

Graph View mode can also be engaged from the custom data list configuration screen. Refer to [Custom](#) on page 35 for details.

Save

The **Save** icon is used to record movies of vehicle datastream values. Saved files can be helpful when trying to isolate an intermittent problem or to verify a repair during a road test.



To save a movie:

- Select **Save**.

A save movie dialog box displays while data is being saved. The movie is saved when the message box disappears.



Figure 4-7 Sample save dialog box

To open saved Scanner data files, from the Home screen select **Data Manager > Scanner Data Folder**, see [Scanner DataViewer Operation](#) on page 146.

Print

See [Printing / Printer Setup](#) on page 27.

More

Whenever the More icon appears on the toolbar it indicates that there are additional options available. Selecting the **More** icon from the Scanner toolbar opens a dropdown menu that offers two choices that only apply to data graphs:

- Scale
- Sweep

Scale

The **Scale** option switches the scale values, displayed along the left-hand side of the data graphs, on and off ([Figure 4-8](#)). The dropdown menu closes once a selection is made.

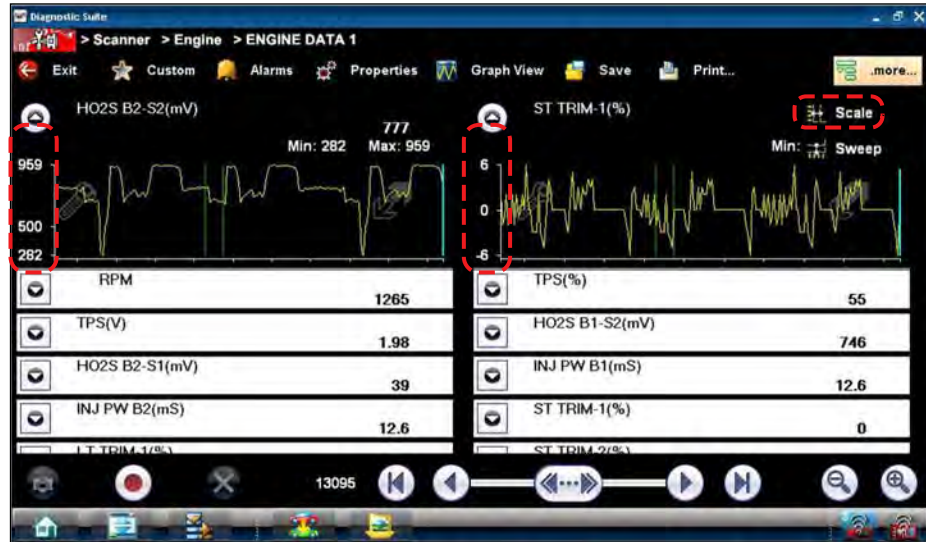

Figure 4-8 Sample data graph scales

Sweep

The Sweep option switches the sweep values, displayed below the data graphs, on and off (Figure 4-9). The dropdown menu closes once a selection is made.

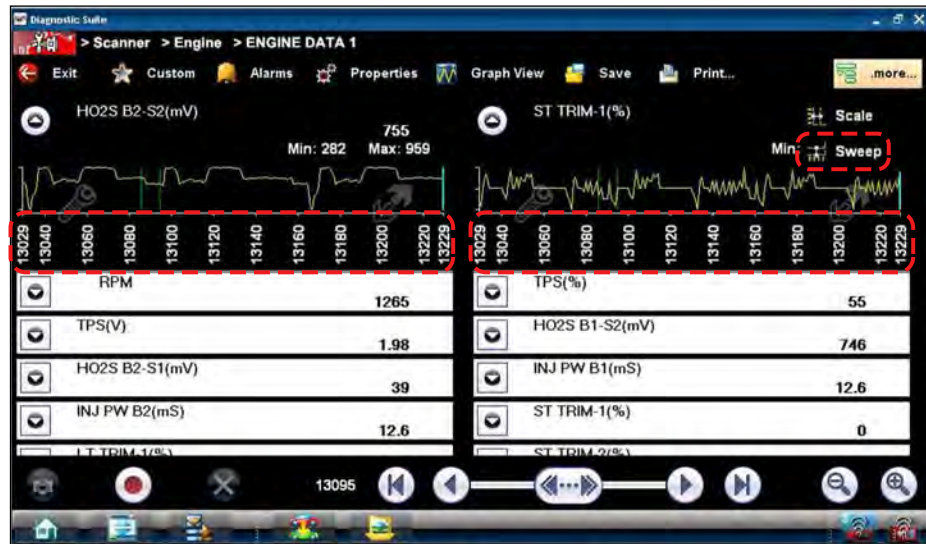

Figure 4-9 Sample data graph sweep











Main Body

The main body of the screen varies depending on the stage of operation. The main body can show vehicle identification selections, the main menu, test data, instructions, troubleshooting information, controls, and other diagnostic information.

Lower Toolbar

Whenever communication is established with a vehicle, the Scanner continuously records data transmitted by the ECM in the data buffer. The toolbar below the main body of the screen contains the icons for navigating the buffered data and other options ([Table 4-2](#)).

Table 4-2 Data buffer toolbar icons

Name	Icon	Description
Snapshot		Arms the software to take a snapshot of vehicle data
Go To Start		Moves to the first frame in the data buffer
Pause		Suspends data capture and changes to show the Play icon
Play		Starts or resumes data capture and changes to show the Pause icon
Go To End		Moves to the last frame in the data buffer
Clear		Erases data in the data buffer
Step Back		Moves to the previous frame in the data buffer
Frame Counter		Indicates the data buffer frame currently displayed
Step Forward		Moves to the next frame in the data buffer
Zoom In		Increases the magnification by decreasing the sweep of the graph
Zoom Out		Decreases the magnification by increasing the sweep of the graph

Use the slider in the middle of the toolbar to quickly move through paused data.



Figure 4-10 Sample data buffer slider

4.2.4 Menu Options

The Toolbar Menu icon at the base of the screen opens a menu near the top of the display.

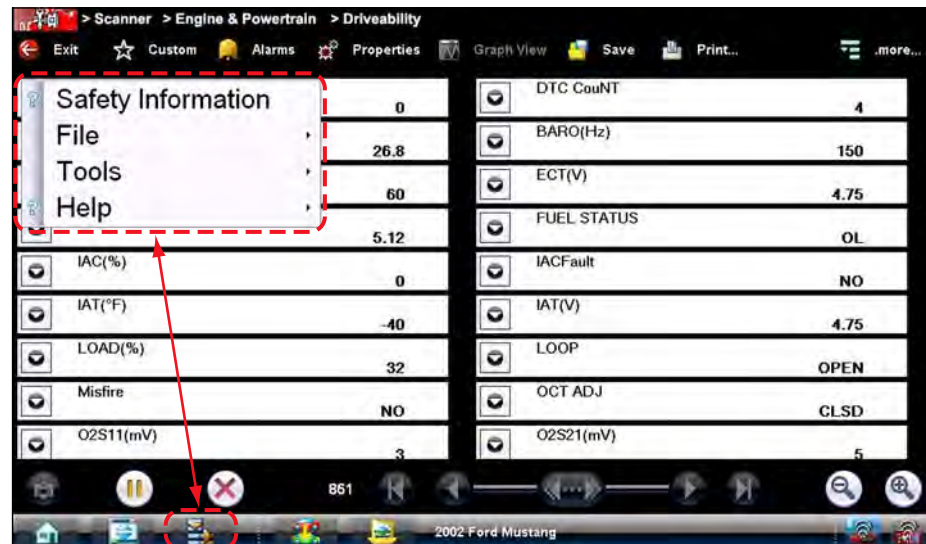

Figure 4-11 Sample Scanner Menu icon options

The following Menu options are available:

- [Safety Information](#)—opens the *Important Safety Instructions* document.
- [File](#)—allows you to print or save the data being viewed.
- [Tools](#)—allows you to perform certain maintenance operations and adjust tool settings.
- [Help](#)—allows you to view supporting documentation.

File

Use to print or save a copy of the data currently being viewed. Menu options include:

- **Save**—opens a submenu with these options:
 - **Screenshot**—saves a graphic image of the current screen.
 - **Collected Data**—saves a recording of all the data currently in the buffer plus the number of frames designated after the trigger event (see [Properties](#) on page 37).
 - **Print**—opens a submenu with these options: (see [Printing / Printer Setup](#) on page 27)
 - **Screen**—sends the current screen image to a printer.
 - **Troubleshooter**—prints the full text of the troubleshooter topic shown in the main body.
- Selecting an option opens a Windows Print dialog box for printing or saving the file.

Tools

This option allows you to adjust tool settings to your personal preferences. Selecting **Tools** opens a menu with two options:

- [Units Setup](#)
- [Display BEN](#)

Units Setup

The units of measurement can be changed for temperature, vehicle speed, air pressure and other pressure readings. Choose between US customary or metric units of measure.



To change the units setup:

1. Select **Tools > Units Setup**.

The Measurement Units Setup dialog box opens.

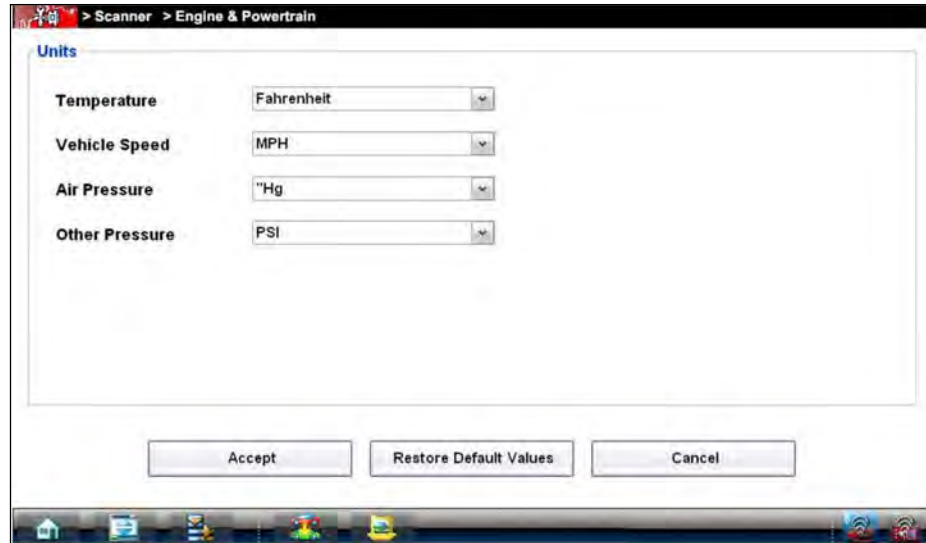

Figure 4-12 Sample Units Setup screen

2. Use the dropdown menus to select the desired value for each item.
3. Select **Accept** to close the dialog box and apply the changes.

Display BEN

Selecting opens a screen with the Balco Engine Number (BEN) of the currently identified vehicle. The BEN is used internally for data coordination, and you may be asked to provide it to a Customer Care representative for troubleshooting communication problems.

Help

A variety of utilities and additional resources are available through the Help menu:

- [User's Manuals](#)
- [About Scanner Hardware Version](#)
- [About Scanner](#)

The User Manual, Version Info, and Activation Status options are the same as explained previously, see [Menu Options](#) on page 42 for details. Other options are explained below.

User's Manuals

This option opens a menu of additional support documentation, such as vehicle communication software manuals, available to assist in your diagnosis. These manuals provide connection information, detailed test procedures, and other resource material for specific vehicles.

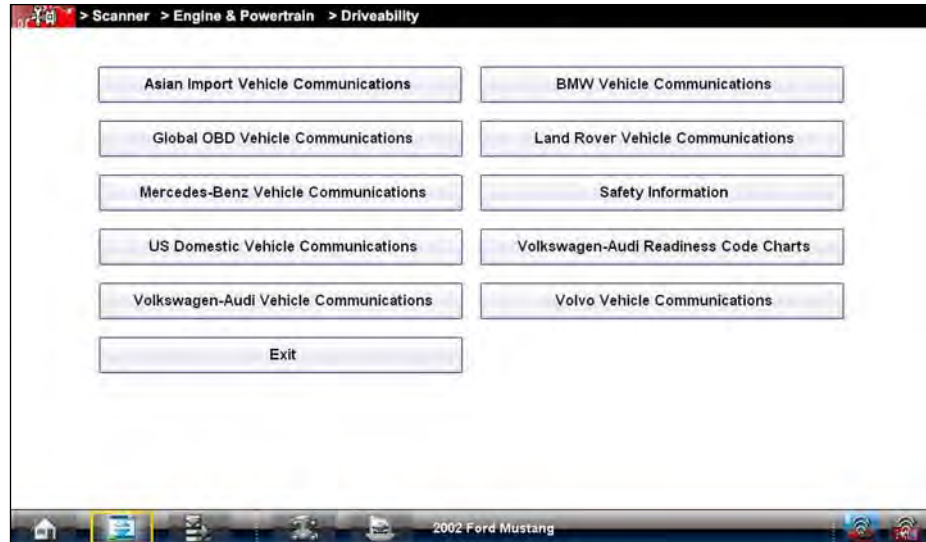

Figure 4-13 Sample User's Manuals menu

Select **Exit** to close the Help module and return to the Scanner.

About Scanner Hardware Version

This option opens a dialog box showing the hardware version and other details about the Scanner module. A **Copy to Clipboard** icon allows you to paste the information to a document or e-mail.

About Scanner

This option opens a dialog box that shows the software version and other Scanner module details. A **Copy to Clipboard** icon allows you to paste the information to a document or e-mail.

4.3 Scanner Operation

The Scanner function has two main operation features:

- **Scanner**—allows communication with the vehicle ECMs to review DTCs, view parameter data, and perform functional tests.
- **Fast-Track Troubleshooter**—provides access to troubleshooting information from a database of experienced based information developed by master technicians.



Basic Scanner Operation Steps

1. **Open Scanner**—Select Scanner on the Home screen.
2. **Identify the vehicle**—Identify the test vehicle by selecting from the menu options.
3. **Connect the data cable to the vehicle**—Follow the on-screen connection instructions to connect the Scan Module to the test vehicle.
4. **Select a system**—Select the system to be tested from the systems menu.
5. **Select a test**—Select the desired test.

4.3.1 Vehicle Identification

The Scanner communicates with the ECMs of the test vehicle and provides vehicle specific data and test results. Vehicle identification is the initial step in using the Scanner function. Once vehicle identification information is entered it is saved in Vehicle History and can be selected again for later use to save time when testing the same vehicle.

The vehicle identification sequence is menu driven, each selection advances to the next screen. A Back icon in the upper left corner of the screen returns to the previous screen. Menu items and procedures may vary by vehicle.



Identifying a vehicle:

1. Select the **Scanner** Function icon from the Home screen.
A list of manufacturers displays ([Figure 4-14](#)).

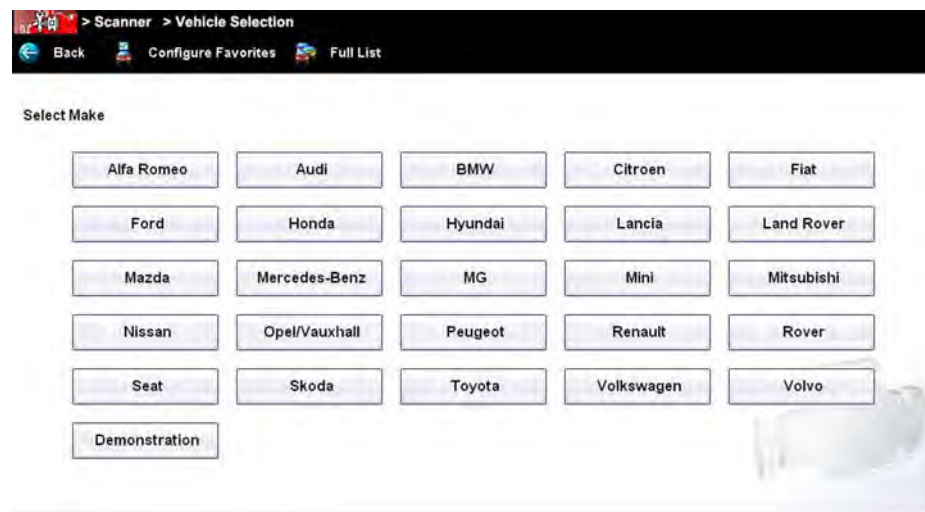

Figure 4-14 Sample manufacturer list

2. Select the manufacturer of the test vehicle from the list.
A model year menu displays.

**NOTE:**

You can limit the number of manufacturers that appear on the list by selecting **Configure Favorites** from the toolbar. See [Creating a Favorites List](#) on page 87 for details.

3. Select the year of the test vehicle from the menu.
A list of vehicle types or models displays. Several selections may be required to identify the vehicle type and model, follow the screen prompts and enter the required information.
A confirmation page showing the identified vehicle displays once all the required data has been entered. Review the information to make sure it is correct.
4. Select **OK**.

Alternative Vehicle Identification

Occasionally, you may try to identify a test vehicle that the Scanner does not recognize, the database does not support, or has some unique characteristics that prevents it from communicating with the Scanner. In these instances, there is an alternate choice that allows you to establish communication with the vehicle:

- **OBDII/EOBD Function**—this function allows you to connect to the OBDII equipped vehicle and perform basic OBD-II or EOBD diagnostic functions, see [OBD Direct Operations](#) on page 78 for additional information.

4.3.2 Connecting the Scan Module

The Scan Module is a wireless device that is connected (using the vehicle data cable) to the vehicle and transmits vehicle data to the Diagnostic Tool. To use the Scanner function the Scan Module must be paired with the Diagnostic Tool. If the Scanner tries to communicate with the vehicle and the Scan Module is not connected to the vehicle, a Connect Data Cable confirmation screen will display. For Scan Module connection and operation information, see [Pairing The Scan Module](#) on page 66.

4.3.3 Vehicle System Selection



Selecting a vehicle system:

1. After the vehicle has been identified, a list of available systems for testing displays (Figure 4-14). Select a system to continue.

The System menu can be displayed in two views, by individual system categories or by common vehicle system categories. To change the view, select/deselect the **Category View** checkbox in the upper toolbar. Typical views are shown in (Figure 4-15 and Figure 4-16).

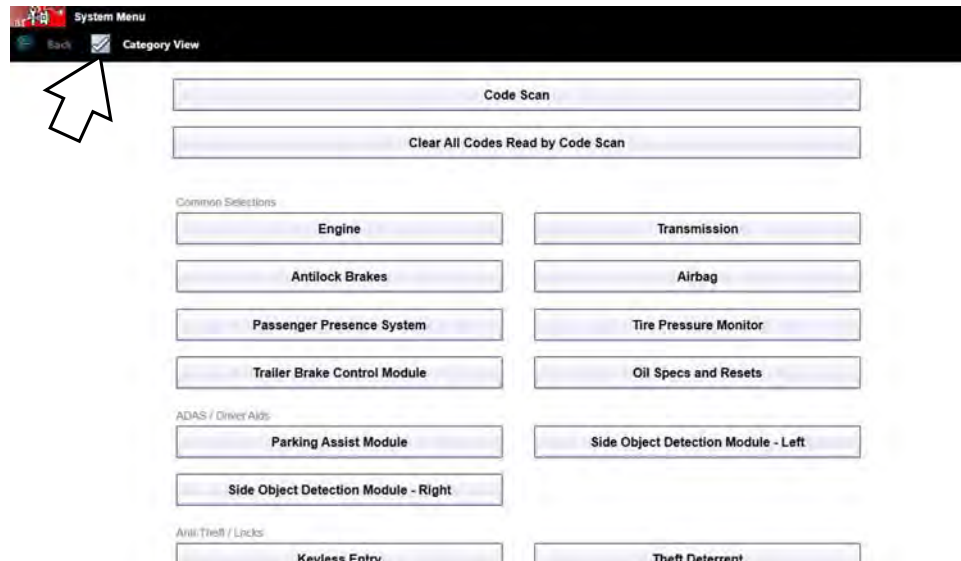

Figure 4-15 Systems menu "Category View" Selected

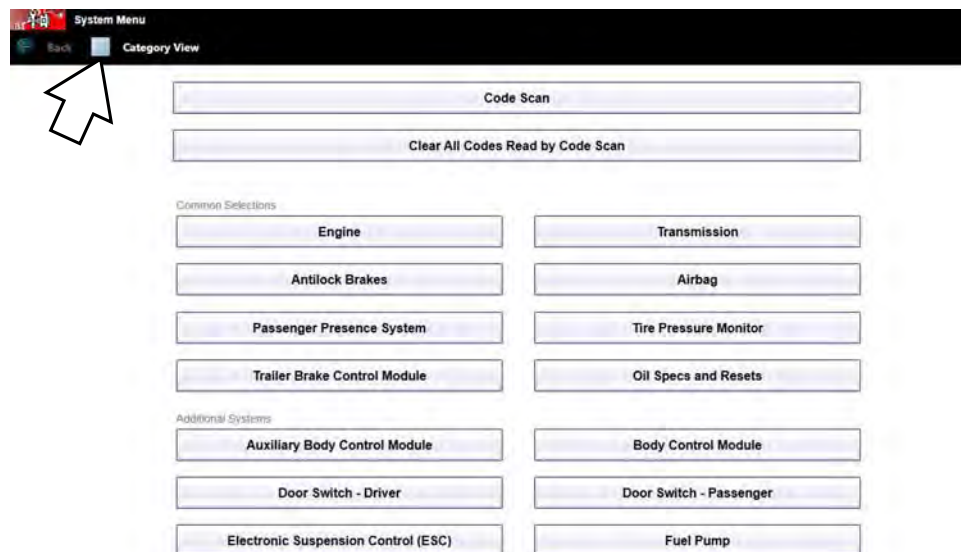

Figure 4-16 Systems menu "Category View" Not Selected

Code Scan (with Vehicle System Report)



NOTE:

Depending on the vehicle, the Code Scan option may be available from the systems menu.

Selecting **Code Scan** starts an active scan of vehicle control modules, and opens the Code Scan results screen (Figure 4-17). A green progress bar is shown at the top of each section indicating the active scanning progress. Once completed, the results are displayed by system category. Depending on the vehicle, the Code Scan option (if supported) may be available from the menu.

The following Code Scan toolbar options are used:

Toolbar Function
Save - Saves the Vehicle System Report as a PDF, see Saving the Vehicle System Report on page 50. Save also attaches the report to the current vehicle record (viewable using the Attachments icon from the vehicle record toolbar).
Print - Allows you to print the Vehicle System Report to your printer, see Printing the Vehicle System Report on page 50.
Refresh - Refreshes the code scan data (restarts the code scan)

The following results are displayed progressively as the modules are scanned:

- **The total number of systems (modules) detected** (Figure 4-17).



Figure 4-17 Code Scan systems analyzed result total

- **A list of all the systems analyzed with DTCs totals.** A categorized system list with DTC totals is displayed in the order they are scanned. To view the main menu for a system in the list, select the system title (Figure 4-18).

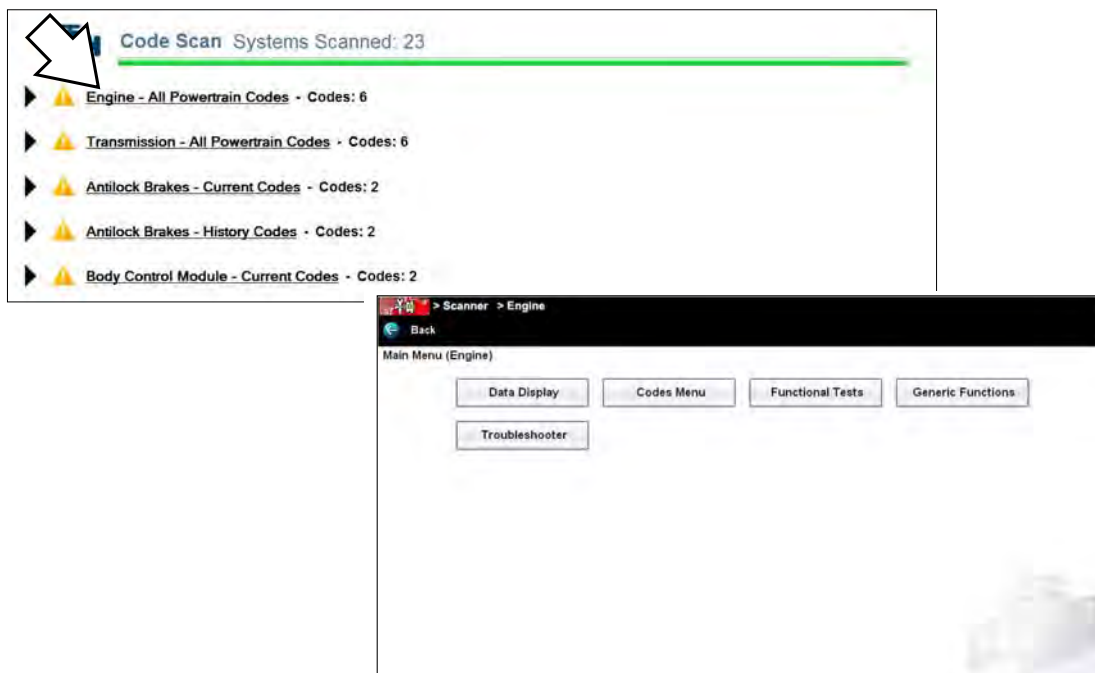

Figure 4-18 System icon (opens Main Menu)

Select the **expand/collapse** icon (Figure 4-19) on the left side of a system category title to expand or collapse a systems' DTC list.

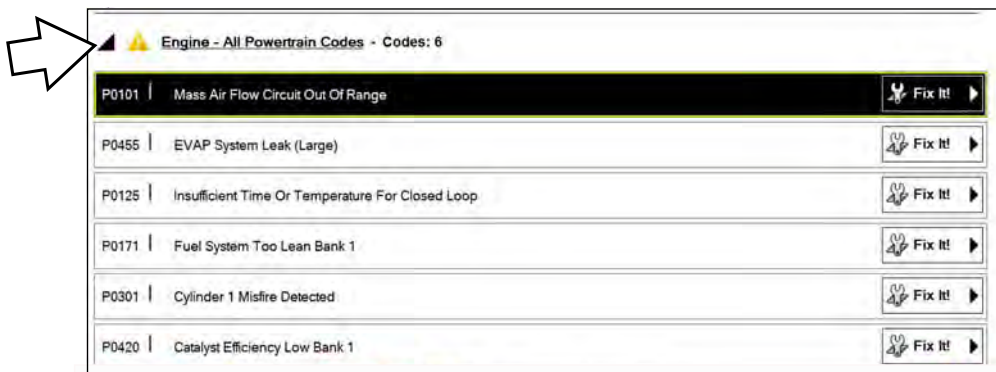

Figure 4-19 Expand/Collapse Icon (expanded result)

- **Global OBDII DTCs.** Towards the end of the Code Scan Report Global OBDII DTCs are displayed (if applicable).
- **Readiness Monitor Test Status.** At the end of the Code Scan Report, readiness monitor test results are displayed as "Tests Complete" or "Not Complete".

4.3.4 Saving the Vehicle System Report

The code scan can be saved as a Vehicle System Report in PDF file format.

The PDF file can be accessed from either of the following locations:

- Vehicle Record attachment field.
- Vehicle System Report Data Folder (in Data Manager).

To save the Vehicle System Report:

1. Perform a code scan.
2. After the code scan has completed, select **Save**.

A confirmation message is displayed indicating that the file was saved and its location.

Message Example: The file is attached to the vehicle record, and can be accessed from Vehicle History or Data Manager. It is located in the System Code Scan Data Folder. File name (example): **C:\Users\ShopstreamUser\Documents\ShopStream\Vehicle System Report Data Folder\Vehicle System Report (date).pdf**.

3. To print or view the file, see [Printing the Vehicle System Report](#) on page 50.

Edit Vehicle System Report Shop Information

To edit the Shop Information displayed on the Vehicle System Report header, see [Shop Information](#) on page 164.

Hide / Show Vehicle System Report Timestamp

See [Code Scan \(Timestamp\)](#) on page 165.

Printing the Vehicle System Report

Before you can print you must install a printer and have a current version of Adobe Reader installed.

To install a printer, see [Printing / Printer Setup](#) on page 27.

To check and/or install Adobe Reader, see [Checking/Installing Adobe® Reader](#) on page 31.

- The Vehicle System Report may be directly printed by selecting the **Print** icon from the code scan toolbar.
- If the file was saved (toolbar Save icon) it may also be printed from either the Vehicle Record attachment, or from the Vehicle System Report Data Folder within Data Manager.

The following sections describe these methods.

Printing (From Code Scan Screen)

After a code scan has been performed, the Vehicle System Report can be directly printed by selecting the **Print** icon from the toolbar.

When print is selected, the file is sent directly to the default printer. The file may be displayed momentarily in the PDF viewer and then minimized (this is normal).

Note: The file is not saved using this method, To save the file, see [Saving the Vehicle System Report](#) on page 50.

Printing (From Data Manager)

When a code scan is saved, the file is saved as a PDF file in the Vehicle System Report Data Folder within Data Manager.

To print the file from Data Manager:

1. Select **Data Manager** from the Home Screen
2. Select and open the Vehicle System Report Data Folder (Figure 4-20).

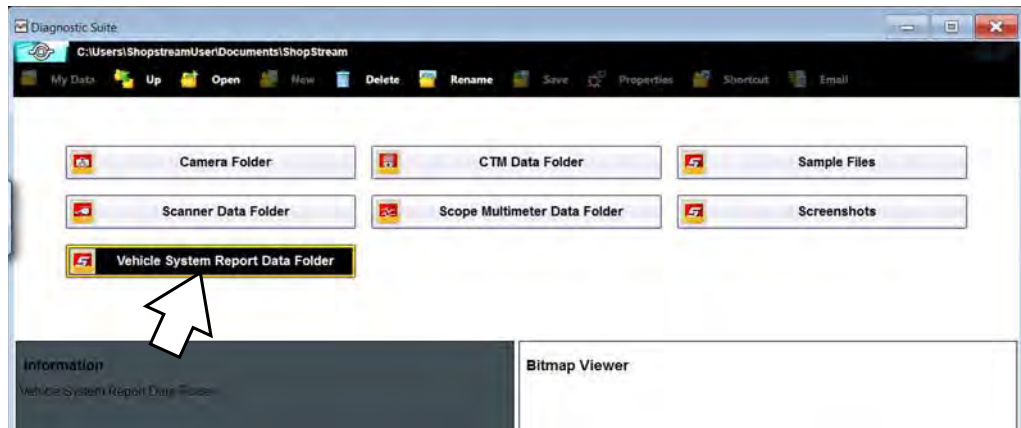

Figure 4-20

3. Select and open the Vehicle System Report PDF file from the list.
4. From the PDF viewer use the menu or toolbar print options to print the file (Figure 4-21).

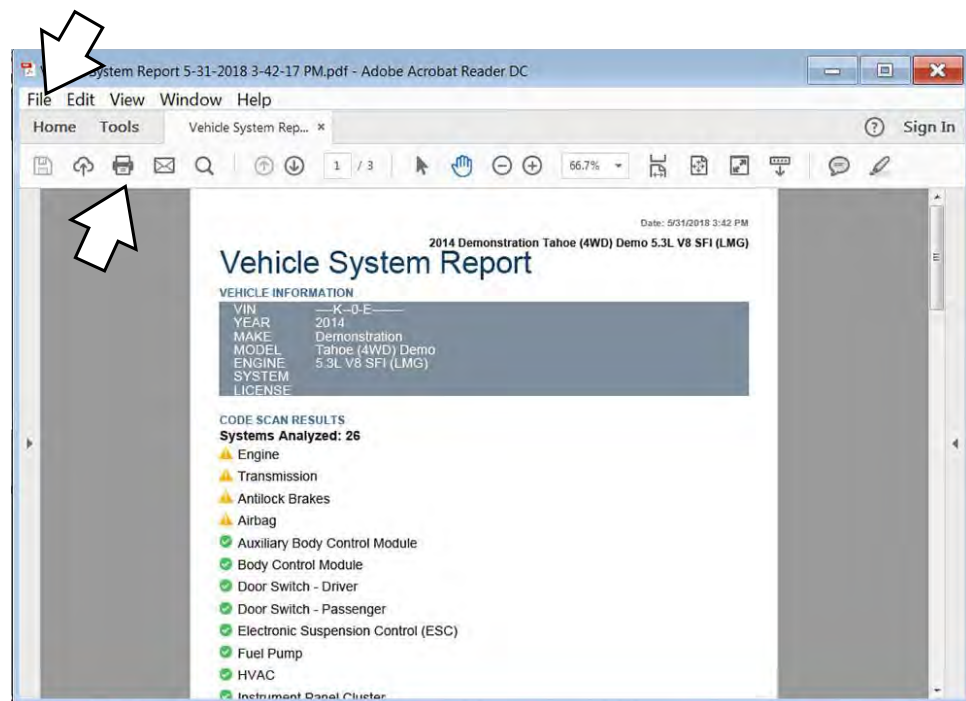

Figure 4-21

Printing (From Vehicle History Record)

When a code scan is saved, the file is saved as a PDF file in the attachments section of the current Vehicle Record.

To print the file from the Vehicle History Record:

1. Select **Vehicle History** from the Home Screen
2. Select and open the vehicle record from the list.
3. Select and open the Vehicle System Report PDF file from the attachments box (Figure 4-22).

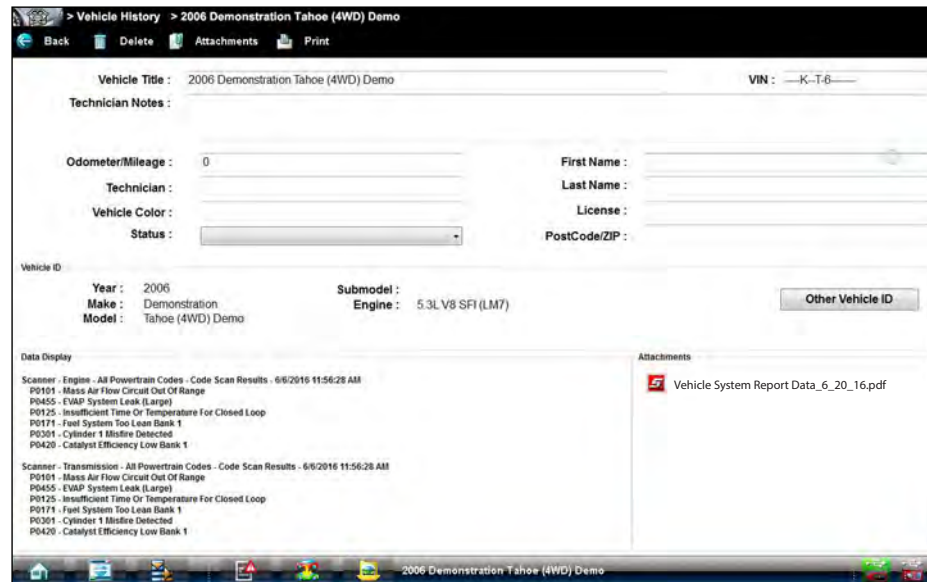

Figure 4-22

4. From the PDF viewer use the menu or toolbar print options to print the file (Figure 4-21).

Clear All Codes Read by Code Scan

Selecting **Clear All Codes Read by Code Scan** erases all DTCs from all vehicle system modules that were read by Code Scan.

4.3.5 Vehicle Test Selection



Selecting a vehicle test:

1. After a system is selected and the Scanner establishes communication with the vehicle, the Scanner Main menu displays available tests. Select a menu item to continue.

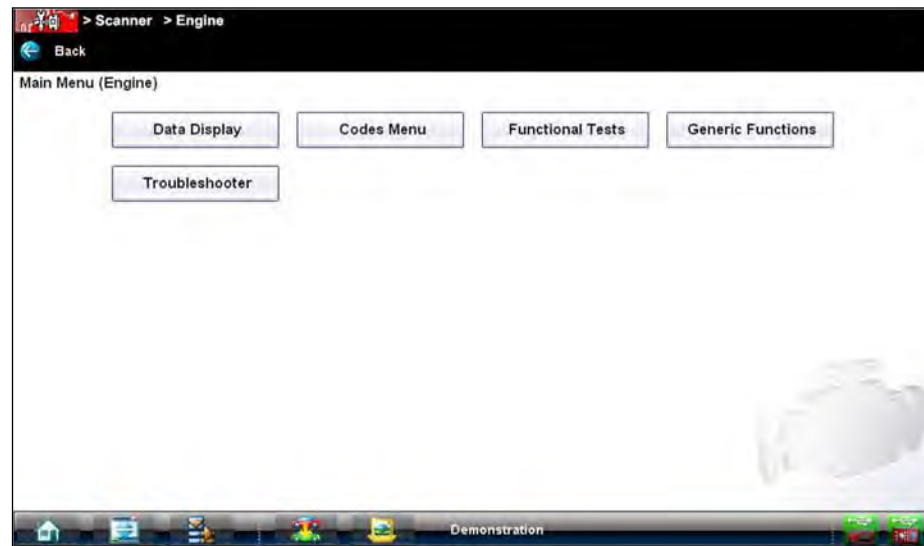

Figure 4-23 Scanner Main menu

Main menu options vary slightly by year, make, and model. The main menu may include:

- **Data Display**—displays data parameter information from the vehicle electronic control module (ECM). Selecting may open a submenu of viewing options.
- **Codes Menu**—displays diagnostic trouble code (DTC) records from the vehicle electronic control module. Selecting may open a submenu of viewing options.
- **Clear Codes**—erases DTC records and other data from the ECM. This selection is found on a Codes submenu for some models.
- **Functional Tests**—provides specific subsystem and Guided Component Tests. The tests vary depending on the manufacturer and model.
- **Actuator Tests**—similar to functional tests, checks the operation of certain actuators, such as solenoid valves and relays.
- **Memory Resets**—allows you to reprogram adaptive values for certain components after making repairs. Selecting opens a submenu. These options are found on the Functional Tests Menu for some models.
- **System Tests**—provides specific subsystem testing. Performing these tests is similar to functional tests.
- **Generic Functions**—lets you access certain available Generic OBD II functions from a proprietary menu (1996 and newer vehicles only).
- **Troubleshooter**—provides step-by-step procedures, integrating parameter data and retrieving trouble codes when appropriate, for specific symptoms of the identified vehicle.

Codes Menu

This selection may appear as Codes, Codes Menu, Codes Only, Codes (No Data), or something similar on the menu. Selecting opens a list of data parameter viewing options that may include:

Display Codes

Selecting opens either a list of diagnostic trouble codes (DTCs) stored in the selected electronic control module (ECM), or a submenu of DTC viewing options. Submenu options may include:

- **Trouble Code Information**—opens a list of codes in ECM memory.
- **History Codes**—opens a list of codes whose symptoms are not currently present. History codes indicate an intermittently occurring problem.
- **Failed This Ignition**—opens a list of codes that set during the current ignition cycle.
- **MIL SVS or Message Requested**—displays ECM requests to light the malfunction indicator lamp (MIL) or service vehicle soon (SVS) lamp, or display a driver information alert.
- **Last Test Failed**—displays a complete list of failed tests.
- **Test Failed Since Code Cleared**—displays a list of tests that failed since the last time codes were cleared from ECM memory.

The code list includes the DTC, and a brief description ([Figure 4-24](#)).

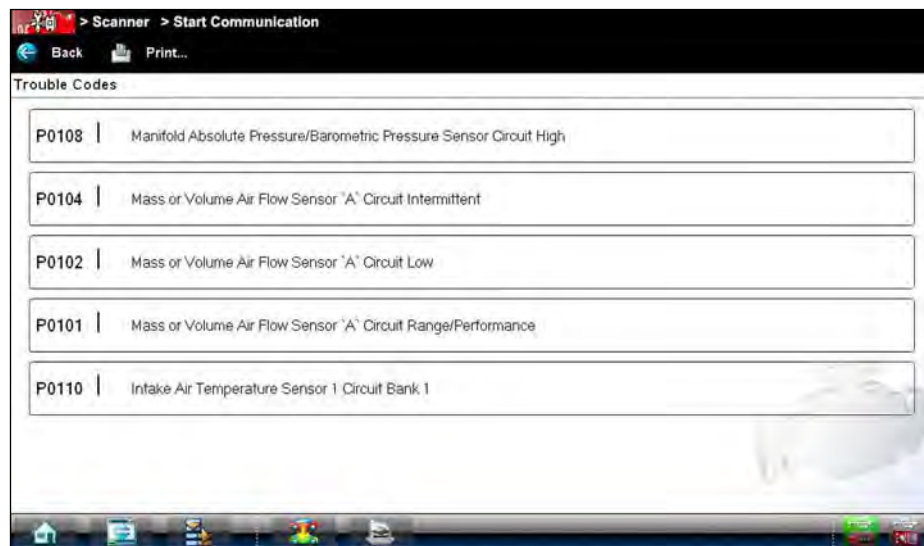

Figure 4-24 Sample code list

Clear Codes

The Scanner clears trouble codes from the ECM memory on some vehicles. If this function is not available on the test vehicle, Clear Codes does not appear as a menu option.



To clear codes:

1. Select **Clear Codes** from the Codes Menu.
A confirmation message displays.
2. Make sure any conditions shown on the confirmation message are met, then select **Yes**.
A “codes cleared” message displays once the operation is complete.
3. Select **Continue** to return to the Codes Menu.

Freeze Frame/Failure Records

This selection displays the DTC that was set, along with corresponding data, when the ECM commanded the malfunction indicator lamp (MIL) to turn on.

DTC Status

This selection allows you to view the records of a particular DTC.



To check DTC status

1. Select **DTC Status** from the Codes Menu.
The DTC Status entry field displays and the virtual keyboard opens ([Figure 4-25](#)).
2. Use the virtual keyboard to enter the characters of the DTC.
3. Select the virtual keyboard **Backspace** icon if needed to erase a character.
4. Select the virtual keyboard **Return** key once all the code characters are entered.

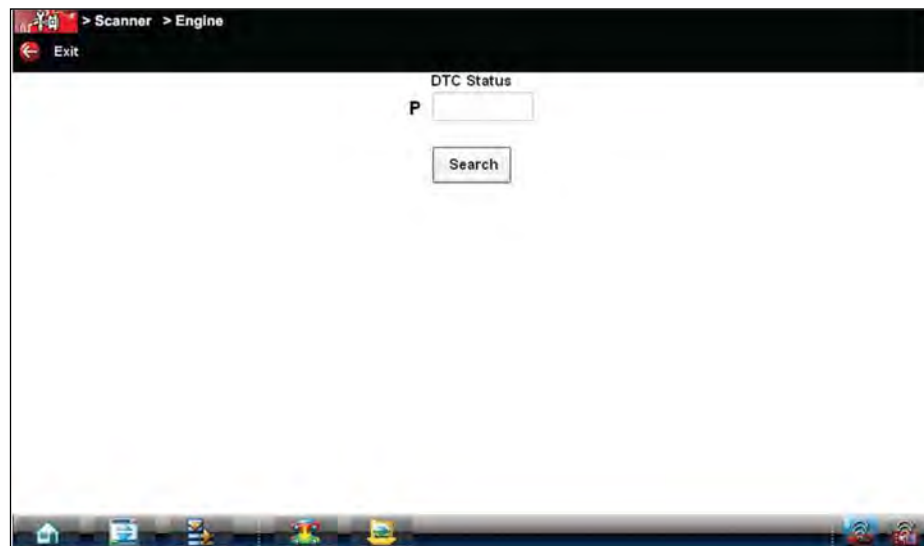

Figure 4-25 Sample DTC Status entry field

The DTC status report displays ([Figure 4-26](#)).

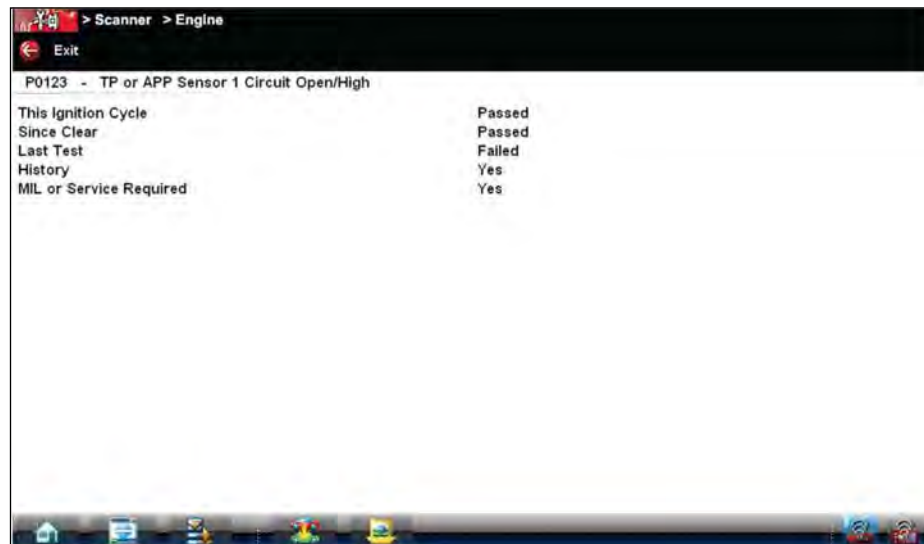

Figure 4-26 Sample DTC status report

5. Select **Exit** to return to the DTC status entry screen.
6. Select **Exit** again to return to the Codes menu.

Data Display

Depending upon the test vehicle, this selection may appear as Data, Data Display, Data Only, Data (No Codes), or something similar. All are similar. Selecting has one of the following results:

- A submenu of data viewing choices displays.
- Vehicle data displays.

A submenu displays when more than one data viewing mode is available on the identified vehicle. On some models, the engine must be started or cranked before data can be displayed. For these models, a “Waiting to Communicate” message displays if the engine was not cranked or started.

Data Screens

When a Data selection is made, the screen displays the data list for the selected module. The items available for any ECM vary from one vehicle to another.

Data is presented in a 2-column format. An abbreviated parameter name is at the left of each column and its value is at the right edge of the column. Parameters display in the order that they are transmitted by the ECM, so expect variation between vehicles.

Gesture scrolling allows you to quickly move through the data list. Simply touch the screen and drag your finger up or down to reposition the parameters being displayed. Position bars momentarily appear to the right of each column to indicate the position of the current screen in relation to the entire list as you scroll. Each column of parameters scrolls independently of the other column. [Figure 4-27](#) shows a typical data screen.

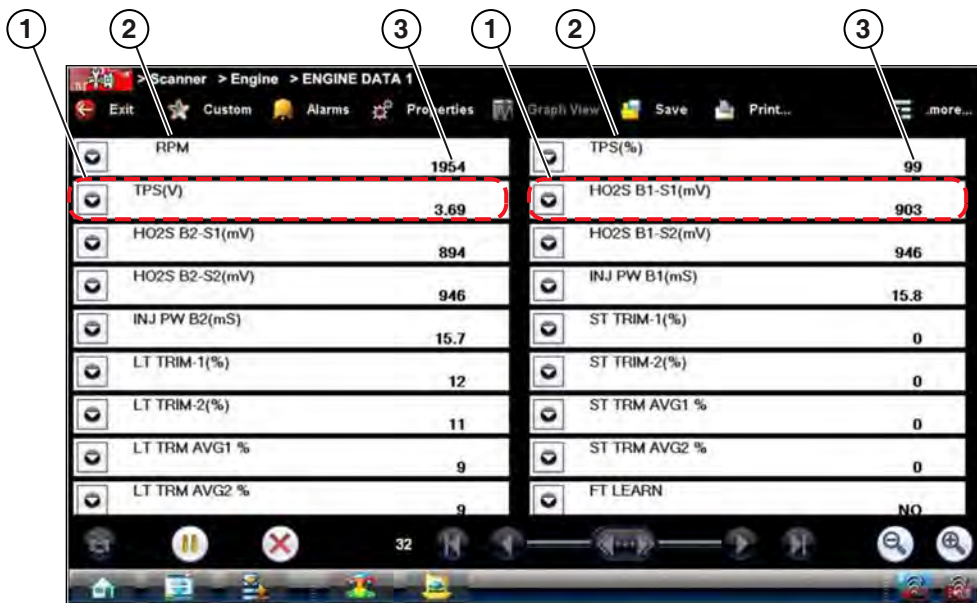

- 1— Graph icon
- 2— Parameter name
- 3— Parameter value

Figure 4-27 Sample data screen

Data Graphs

Select the **Graph** icon to open a data graph for that parameter (Figure 4-28). Selecting a parameter for graph view moves it to the top of the list. Select the **Graph** icon again to close the graph for that parameter and return to a data list view.

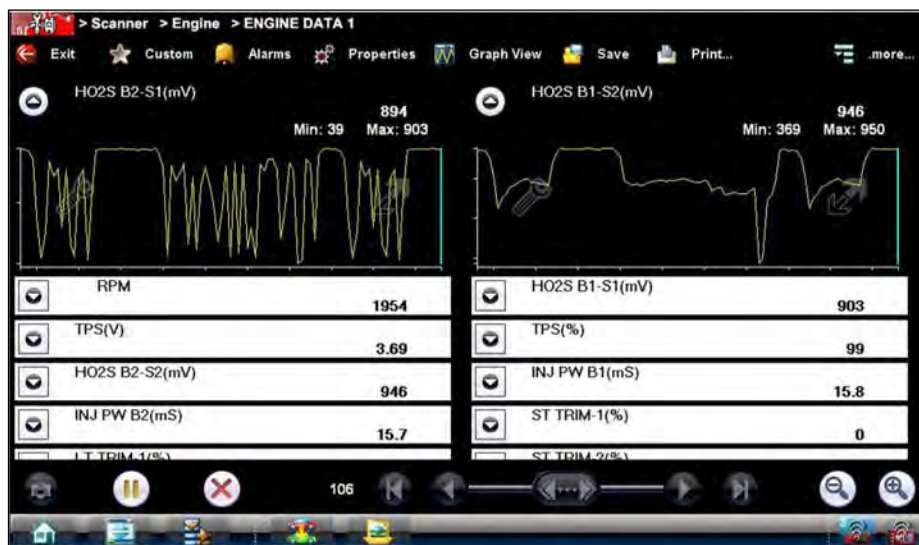



Figure 4-28 Sample graph view

The icons that display on each data graph allow you configure settings for the selected graph only:

Table 4-3 Data graph icon operations

Name	Icon	Description
Expand/Collapse		Select to expand the graph to fill the entire screen, select again to collapse the graph to the standard view.
Graph Properties		Select to open the Graph Properties dialog box, which allows you to set triggers for recording a snapshot and to adjust the scale.

Triggers

Triggers establish threshold values, an upper limit and a lower limit, for recording a data snapshot. A snapshot allows you to closely evaluate conditions that caused the triggering event.

When a snapshot is taken, the Scanner captures additional data after the trigger point is detected, data collection pauses, and the buffered information is automatically saved as a movie. This gives you a complete picture of what was happening before the fact, what occurred at the trigger point, and what happened after the fact.

Data collection is paused following a trigger event. Select the **Play** icon to resume viewing live data. A vertical line now appears on each of the data graphs to indicate the triggering point. The trigger line on the parameter that triggered the snapshot is a different color than those on the other graphs. This makes it easy to determine which parameter caused the trigger when triggers are set for multiple parameters.



To adjust the amount of data collected after a trigger:

1. Select the **Properties** icon on the Scanner toolbar to open the dialog box.
2. Highlight one of the **Samples After Trigger** options:
3. Select the Accept icon to close the dialog box.



NOTE:

You can also adjust the amount of data collected after a triggering event using the Properties icon on the Scanner toolbar. See [Properties](#) on page 37 for additional information.



To set triggers and record a snapshot:

1. Select the Graph Properties icon on the parameter graph you wish to set triggers on.
The Graph Properties dialog box opens.
2. From the Graph Properties dialog box, select **Triggers On**.
A check mark appears in the box and the Min and Max fields activate ([Figure 4-29](#)).
3. Select either **Max:** (maximum) or **Min:** (minimum) to activate that field and open the keyboard.
4. Type the desired trigger value into the field.
5. Select the other field and enter a trigger value, then close the virtual keyboard.
6. Select **Save** to close the dialog box.
Trigger lines (blue for upper and red for lower) display on the selected parameter graph.

The area between the upper and lower trigger lines establishes the triggering condition. Any data points that register outside of the set trigger conditions initiates a snapshot.

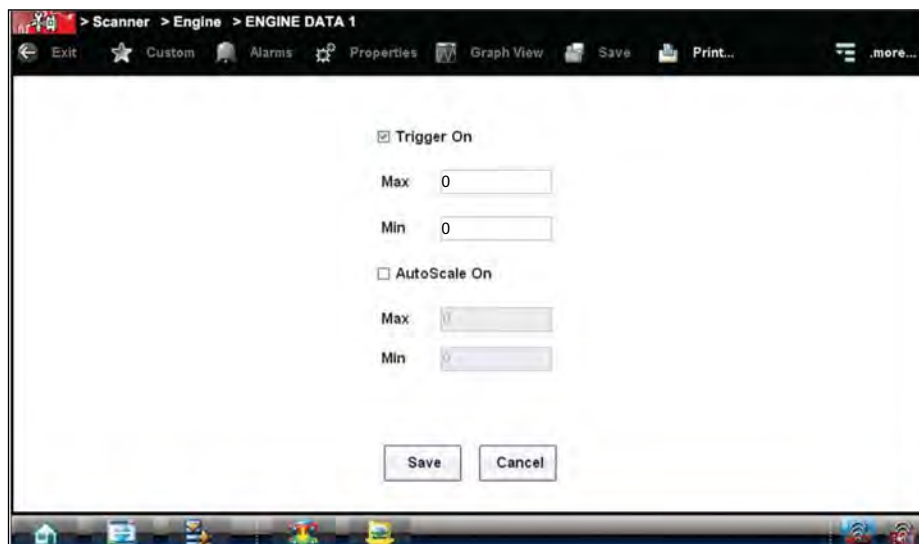

Figure 4-29 Sample Graph Properties dialog box

7. Select **Snapshot** on the Data Buffer Toolbar to arm the snapshot. The Snapshot icon changes color to indicate it has been armed (Figure 4-30).



Figure 4-30 Sample armed Snapshot icon

Once all of the data is compiled, data collection pauses and the information is saved as a movie. A confirmation screen displays to let you know the name automatically assigned to the saved file and where to locate it.



Figure 4-31 Sample saved movie confirmation screen

8. Select **OK** to close the confirmation screen.
9. Select the **Play** icon on the toolbar to resume viewing live data.

**NOTE:**

Selecting an armed Snapshot icon disarms it.

Scale

Scale adjusts the upper and lower values displayed on the vertical axis of a data graph. Two scale modes are available; auto scale and manual scale. Auto scale, which is the default setting, automatically adjusts the graph scale based upon the minimum and maximum values transmitted by the ECM. Manual scale allows you to set the minimum and maximum values.

**To manually set the scale on a graph:**

1. Select the Graph Properties icon to open the dialog box for the graph you wish to scale.
2. From the Graph Properties dialog box (Figure 4-32), select **Auto Scale On**.
The check mark is cleared from the box and the minimum and maximum fields activate.
3. Select either **Max:** (maximum) or **Min:** (minimum) to activate that field and open the keyboard.
4. Type the desired scale value into the field.
5. Select the other field and enter a value, then close the virtual keyboard.
6. Select **Save** to close the dialog box.

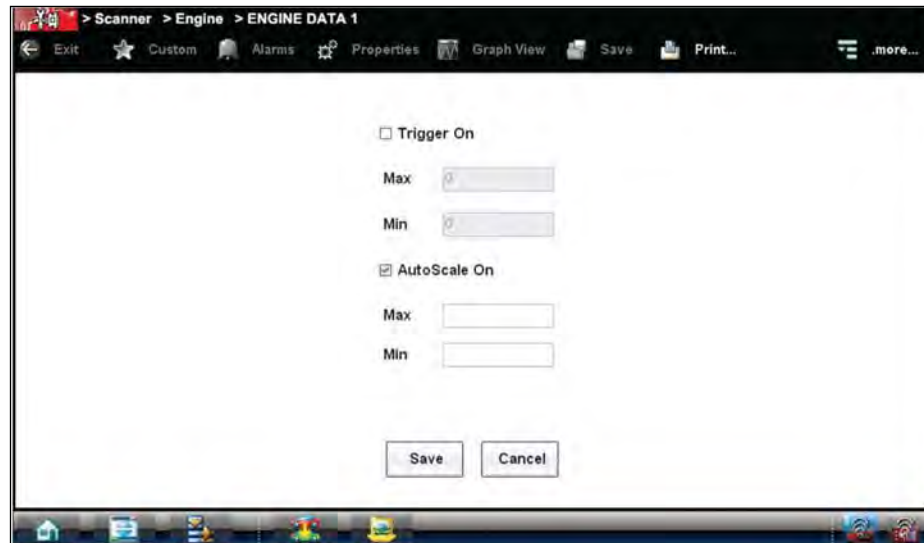

Figure 4-32 Sample manual scale selection

The dialog box closes and the parameter scale is now at the set values.

Using Zoom

The zoom options on the Data Buffer toolbar allow you to change the magnification level of the sweep when viewing data graphs. Use the **Zoom In (+)** icon to increase magnification, and the **Zoom Out (-)** icon to decrease magnification.

Functional Tests

The **Functional Tests** selection is used to access vehicle-specific subsystem and guided component tests. Available tests vary by manufacturer, year, and model, and only the available tests display in the menu.

There are four general types of functional test operations:

- **Information Tests**—are read-only tests, like selecting “VIN” from a Functional Tests menu to display the VIN of the identified vehicle.
- **Toggle Tests**—switch a component, such as a solenoid, relay, or switch, between two operating states.
- **Variable Control Tests**—command a certain value for a system or component, such as varying the spark timing in 1° increments or the EGR valve duty cycle in 10% increments.
- **Reset Tests**—reset the adaptive, or learned, values that are stored in the electronic control module.

Selecting **Functional Tests** opens a menu of test options that varies by make and model. Selecting a menu option either activates the test or opens a submenu of additional choices. Follow all screen instructions while performing tests. How and what information is presented on the screen varies according to the type of test being performed.

IMPORTANT:

Do not enter any functional tests while driving on a road test. During some functional tests, the ECM makes changes to ignition timing, fuel delivery, and other engine functions, which may affect engine operation and vehicle control.

Some toggle and variable control tests display functional test controls at the top of the screen with data stream information below ([Figure 4-33](#)).

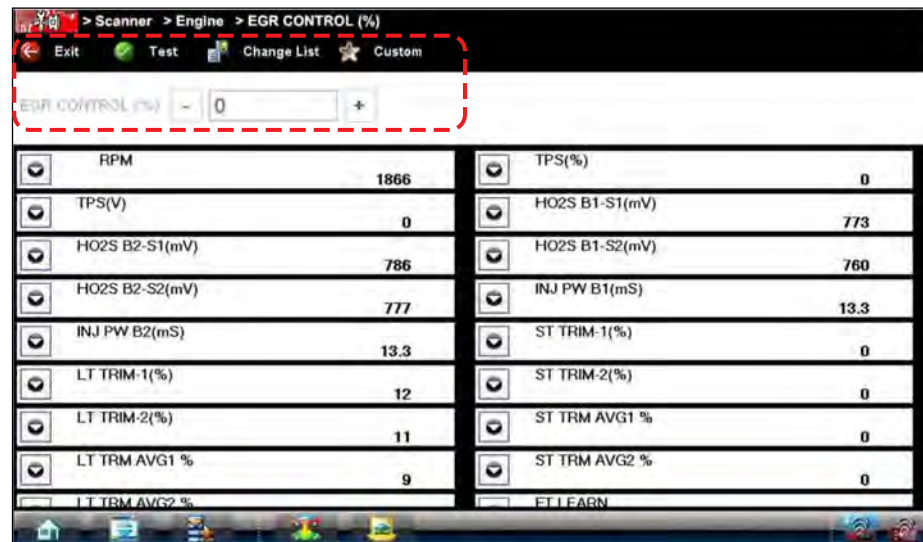

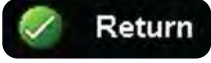

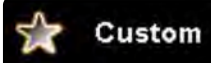



Figure 4-33 Sample functional test controls

Functional test controls allow you manipulate the test signal as shown in Table 4-4.

Table 4-4 Functional test control icons

Name	Icon	Description
Test		Activates the test.
Return		Moves focus back to the data list.
Change List		Allows you to switch data lists.
Custom		Allows you to select which parameters display during the functional test.
Minus		Switches an item to low or off, or incrementally reduces a variable signal.
Plus		Switches an item to high or on, or incrementally increases a variable signal.

Generic Functions

The **Generic Functions** selection opens a menu of available OBD-II/EOBD functions on 1996 and newer vehicles. For additional information on generic functions refer to the *Global OBD Vehicle Communications Software Manual*. Menu options typically include:

- MIL Status - displays the ID and status of the Malfunction Indicator Lamp (MIL)
- Fast Track[®] Troubleshooter - displays a menu of available experience-based tests and tips
- Readiness Monitors—displays the status of the OBD-II/EOBD required monitors
- (\$01) Display Current Data - displays a screen containing Generic OBD PID data
- (\$02) Freeze Frame—displays data stored in ECM memory when a DTC is set
- (\$05) Oxygen Sensor Monitoring—displays on-board oxygen sensor monitoring test results
- (\$06) On-Board Monitored Systems—displays the status of system monitors
- (\$08) Request Control of On-Board System—establishes bidirectional ECM communication
- (\$09) Calibration Identification—displays the ECM calibration identification numbers
- (\$09) Calibration Verification Number—displays the ECM calibration
- (\$09) In-Use Performance Tracking—displays a monitoring conditions report
- (\$09) Vehicle Identification Number—displays the VIN
- (\$0A) Emissions Related Fault with Permanent Status—displays a record of permanent codes

Troubleshooter

Fast-Track[®] Troubleshooter is a database of experience-based information of validated real-world repair strategies that have been compiled by top-notch technicians. Troubleshooter simplifies the diagnosis process, as it contains information on virtually all common diagnostic trouble code (DTC) problems and driveability symptoms.

Troubleshooter information is organized into a series of diagnostic tips that are designed to quickly lead you to the root cause of a particular problem. The tips are vehicle-specific, which means only tips that relate to the identified vehicle are presented. Selecting opens a menu that may include:

- **Code Tips**—provides detailed information on setting conditions, testing, and interpreting test results for specific codes.
- **Symptom Tips**—provides diagnostic tests and procedures based on vehicle operation.
- **Time Savers**—provides supplemental information, such as firing order and #1 cylinder location, that may be needed to make a diagnosis.
- **Common Problems**—provides advice and remedies for certain “pattern failures” that have been experienced on vehicles of the same model.
- **Tests and Procedures**—explains how to perform certain tests on the specific test vehicle. Some tips provide specifications and installation information as well.
- **Fast-Track Data Scan (Normal Values)**—contains information and guidelines on how to validate data readings for certain sensors and actuators, live data values are provided.



NOTE:

Troubleshooter appears in a Scanner menu only if tips are available for the system selected on the identified vehicle.

Certain live data parameter values display directly within the tip when performing Troubleshooter tests and procedures. A tip may also contain a hyperlink to a Troubleshooter Reference, another test or procedure, or a supplemental operation, such as Clear Codes. Hyperlinks are shown in blue, and selecting them opens the link. Troubleshooter References open in a separate window. (Figure 4-34).

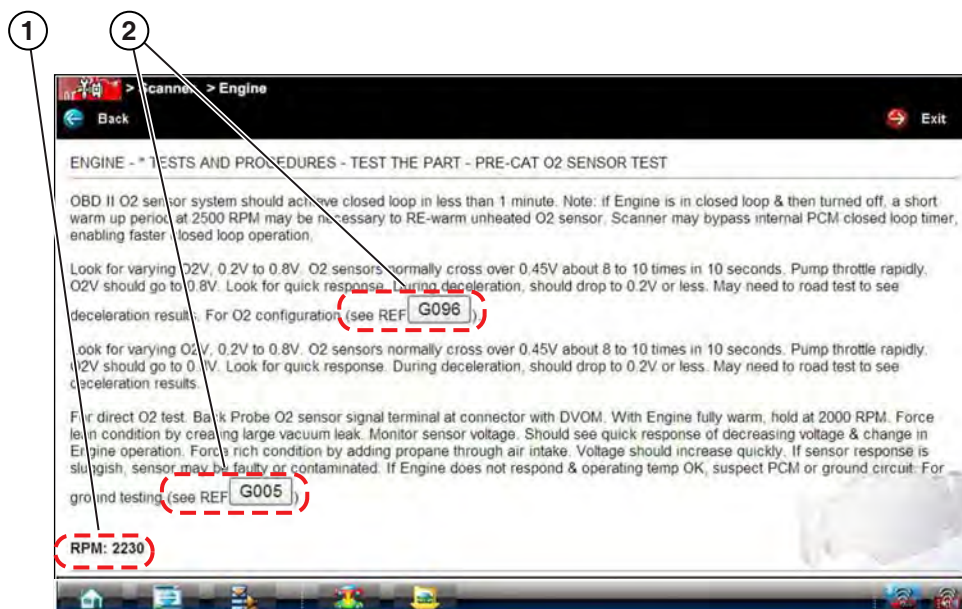

1— Live data values

2— Hyperlink

Figure 4-34 Sample data values within a Troubleshooter tip

4.4 Stopping Communication and Exiting the Scanner

The Scanner remains open as long as there is an active communication link with the vehicle. You must first stop communication with the vehicle in order to exit from the Scanner function. A warning message displays if you attempt to exit from the Scanner while it is communicating with the vehicle ECM.

**NOTE:**

Damage to the vehicle electronic control module (ECM) may occur if communication is disrupted. Make sure the data cable and the USB cable are properly connected at all times during testing. Exit all tests before disconnecting the test cable or turning off the tool.

**To exit Scanner and disconnect from a vehicle:**

When disconnecting the Diagnostic Tool from the vehicle, make sure the Scanner software is not communicating with the vehicle.

1. From a codes or data display screen, select the **Exit** icon on the upper toolbar.



Figure 4-35 Exit icon

The screen goes to the codes or data menu.

2. Select the **Back** icon on the upper toolbar.



Figure 4-36 Back icon

The screen goes to the system menu.

3. Select the **Back** icon on the upper toolbar.
A "stopping communication" message briefly displays followed by the systems menu.
4. Select the **Change Vehicle** icon on the Toolbar.



Figure 4-37 Change Vehicle icon

The vehicle description on the toolbar should now read "No Active Vehicle".

5. Select the **Home** icon on the Toolbar.



Figure 4-38 Home icon

The Home screen displays.

6. Disconnect the data cable from the vehicle diagnostic connector.

This chapter describes the connection, operation, troubleshooting and updating of the Scan Module.

5.1 Overview

The Scan Module is a wireless device that is connected to the vehicle and transmits vehicle data to the diagnostic tool.

The Scan Module operates on 12 or 24VDC vehicle power, supplied through the vehicle's data link connector (DLC).

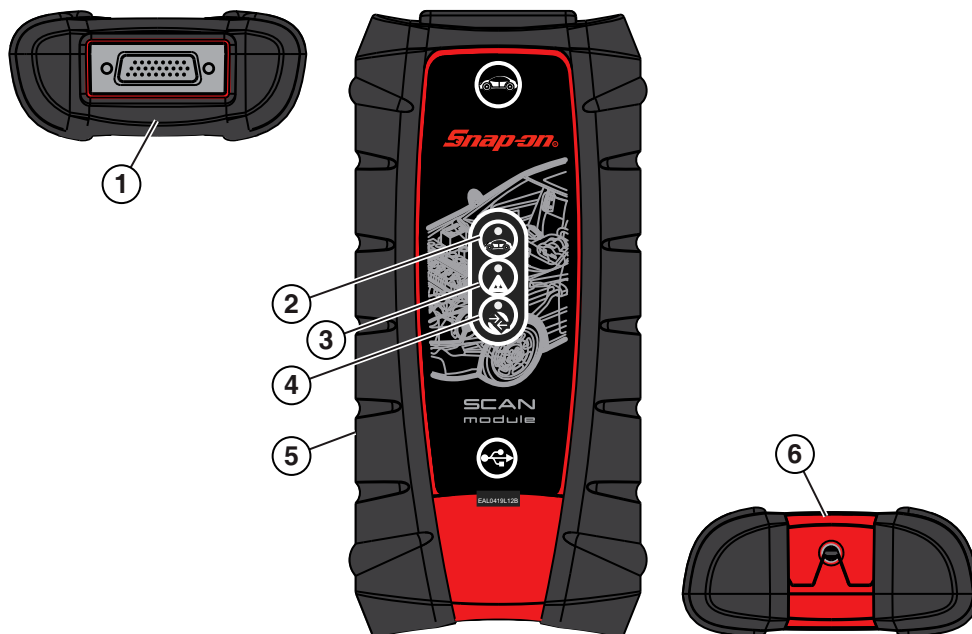

- 1— Data cable connector
- 2— Vehicle power LED (green)
- 3— Communication issue LED (red)
- 4— Bluetooth LED (green)
- 5— Memory card port (remove protective hand grip for access)
- 6— Universal serial bus (USB) jack (remove protective hand grip for access)

Figure 5-1 Scan Module

5.2 Pairing The Scan Module

To use the Scan Module with the Scanner or OBD-II/EODB functions, it must first be paired with the diagnostic tool.

Pairing is the wireless connection (identification) process used to connect the Scan Module to your diagnostic tool.

The Scan Module only needs to be paired once before it's initial use. The connection configuration should remain in memory for all future uses, unless the connection configuration is removed or lost.

**NOTE:**

Wireless devices shown in this section are used as reference. Not all devices shown may be applicable to your diagnostic tool.

**To pair the Scan Module with the diagnostic tool:**

1. Turn on the diagnostic tool.

IMPORTANT:

The Scan Module needs to be powered on during the pairing process. Connect the Scan Module to a vehicle or to the diagnostic tool using the USB cable. Make sure the diagnostic tool has a charged battery or is connected to the AC/DC power supply.

2. Connect the 26-pin end of the data cable to the Scan Module data cable connector.
3. Connect the 16-pin end of the data cable to a vehicle data link connector (DLC).
The green LED on the Scan Module is illuminated when power is being supplied to the Scan Module. For additional information on the Data Cable, see [Data Cable Connection](#) on page 68.
4. From the diagnostic tool select **System Settings > Paired Devices**.
5. Select **Add** from the toolbar, then **OK** when prompted.

The diagnostic tool searches for compatible wireless devices, then displays the results. (Figure 5-2).

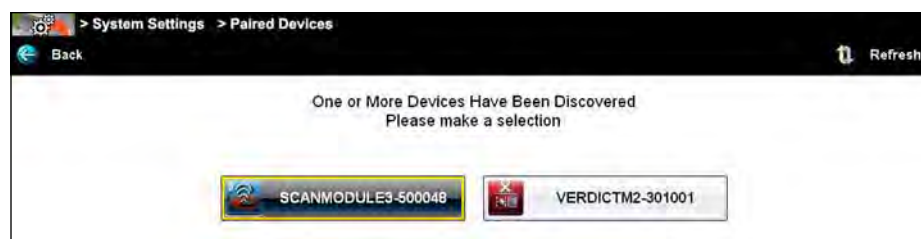

Figure 5-2 Sample Scan Module selection

**NOTE:**

Search results include all compatible wireless devices detected, and may include multiple Scan Modules if you are in a shop environment where more than one unit is powered on. Available module listings include a partial serial number. Make sure the screen listing matches the last six digits of the serial number of your Scan Module before continuing. Scan Module serial numbers are also printed on the back of the Scan Module (e.g. 123SMC-987654)

6. Select the Scan Module you wish to connect from the results list.

A search in progress message displays during the pairing procedure (Figure 5-3), the Paired Devices screen (Figure 5-4) displays once the procedure completes.

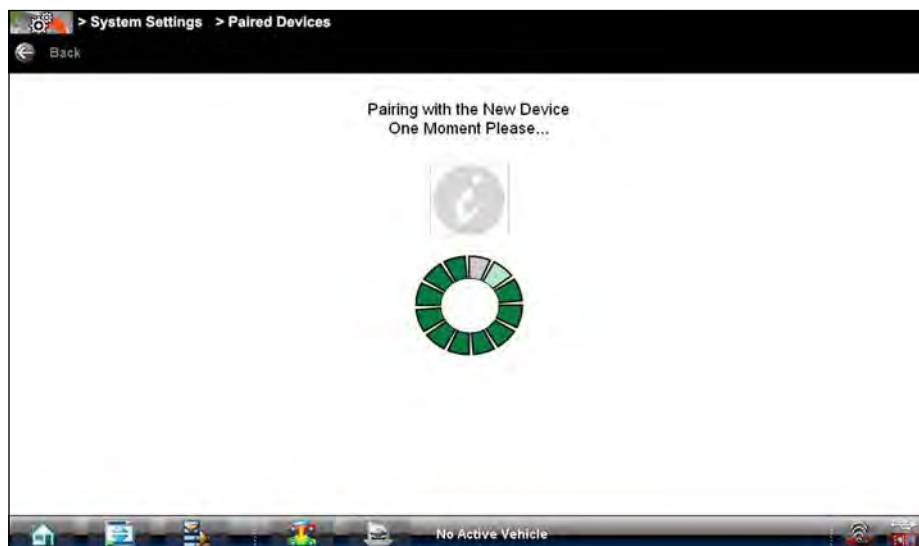

Figure 5-3 Sample pairing in progress message

7. Select the **Home** icon on the Toolbar.
8. Disconnect the data cable from the vehicle.

The Scan Module and diagnostic tool are now paired for wireless communication and should automatically recognize each other when both are powered up.

5.3 Checking Scan Module Paired Status



To check if the Scan Module is paired to your diagnostic tool:

1. Select **System Settings > Paired Devices**.

The paired devices screen opens (Figure 5-4).

The Paired Devices screen lists all of the devices paired to the diagnostic tool, and also indicates whether or not there is active communication occurring.



Figure 5-4 Typical Paired Devices screen

2. Verify the Scan Module is in the list of paired devices.

5.4 Data Cable Connection

To use the Scan Module for Scanner and OBD-II/EOBD testing, it must first be connected to the vehicle's data link connector (DLC).

Depending on the vehicle, the supplied DA-4 data cable may be used alone or may require optional adapters.

- **All OBD-II/EOBD compliant vehicles** - Use the supplied DA-4 data cable. The 26-pin end of the cable attaches to the data cable connector on the Scan Module. The 16-pin end connects to the vehicle DLC. The cable connectors are secured with captive screws.
- **All non-OBD-II/EOBD (OBD-I) compliant vehicles** - Use the supplied DA-4 data cable with the optional DA-5 adapter and a manufacturer specific adapter. The 26-pin end of the cable attaches to the data cable connector on the Scan Module. The 16-pin end connects to the DA-5 adapter, the DA-5 adapter connects to the manufacturer specific adapter and then connects to the vehicle DLC. The cable connectors are secured with captive screws.

While using the Scanner and OBD-II/EOBD functions, on-screen cable and adapter connection instructions are provided. The instructions may also include the location of the vehicle DLC (Figure 5-5). If required, additional connection information can be found in the appropriate vehicle communication software manual for the vehicle. Vehicle communication software manuals are available online, see the website information at the front of this manual.

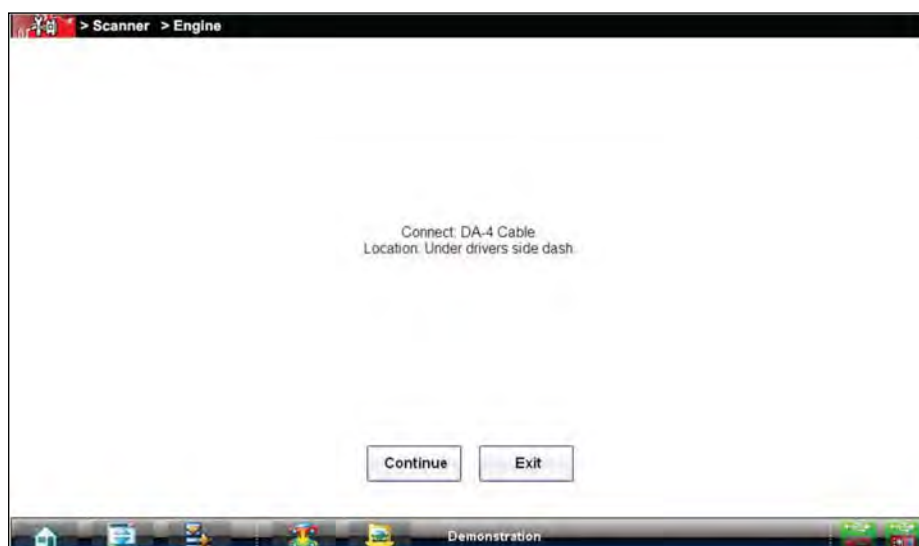

Figure 5-5 Vehicle connection data cable message

For data cable vehicle power connection information, see [Vehicle Power](#) on page 6.



To connect the data cable to the vehicle:

1. While using the Scanner or OBD-II/EODB function, follow the on-screen instructions for connecting the cable and/or any adapters required to the vehicle ([Figure 5-5](#)).
2. Select **Continue** once the data cable is connected to the vehicle.

5.5 Troubleshooting

The Scan Module is a wireless communications device that uses Bluetooth technology to transmit vehicle data to the diagnostic tool without a physical connection. The working range of the transmitter is about 30 feet (9.14 m). Scan Module operations can be impacted when signal interference, or some other condition, disrupts or impairs the wireless communication network. These interruptions are usually temporary and easily repaired.

Indicators of wireless communication interference include:

- Slow Scan Module response accompanied by “Error 101” message.
- Slow Scan Module response accompanied by “Error 404” message.
- “Error Occurred” Message when trying to use the Scan Module.
- “Error Occurred” Message after 20 or more minutes sitting idle, particularly if the devices have been stationary.

5.5.1 No Communication Message

If the Scan Module is paired to the diagnostic tool and tries to communicate with the vehicle and the Scan Module is not connected to the vehicle, a “Connect Data Cable” or “no communication” message displays.

A signal lost due to moving out of range automatically restores itself when the diagnostic tool is brought closer to the Scan Module. The Scanner sounds a tone when the signal is lost.

The following conditions cause a “no communication” message to display:

- The Scanner is unable to establish a communication link with the vehicle.
- You selected a system for testing that the vehicle is not equipped with (such as ABS).
- There is a loose connection.
- There is a blown vehicle fuse.
- There is a wiring fault on the vehicle, or in the data cable or adapter.
- There is a circuit fault in the data cable, Personality Key, or adapter.
- Incorrect vehicle identification was entered.

Refer to the Vehicle Communication Software manuals for manufacturer-specific troubleshooting information.





5.5.2 Signal Loss / Out of Range Alarm

A signal lost due to moving the diagnostic tool out of range of the Scan Module will automatically restore itself when the diagnostic tool is brought closer to the Scan Module. The Scan Module will sound an audible tone when the signal is lost.

5.5.3 Checking Hardware Status

Verifying the Hardware Status is always the first step in troubleshooting a wireless connection issue.

The Hardware Status indicators in the lower-right corner of the Home screen provide a quick reference to wireless operations. The background color of the status indicator icon represents the condition of the wireless connectivity to that device. Icon status is shown in the table below:

Hardware Icon	Background Color	Condition	Action
	Red	Not Paired	Pair the Scan Module to the diagnostic tool. See Pairing The Scan Module on page 66 for instructions.
	Grey	Paired, but Not Communicating	You may have moved out of range. Move the diagnostic tool closer to the Scan Module to reestablish communications. If connectivity is not restored, perform the Recovery Procedure on page 72.
	Blue	Paired and Communicating	Hardware status is good and Bluetooth should be functional. Verify that the green Bluetooth LED on the front of the Scan Module is flashing. If there is no connectivity, perform the Recovery Procedure on page 72.
	Green	USB Cable Connected	Indicates the USB cable is connected.
	Gray	USB Cable Not Connected	Indicates the USB cable is not connected or connected but not allowing communication

The three light emitting diodes (LEDs) on the faceplate of the Scan Module let you know at a glance whether or not there is an active connection between the two modules. The two green LEDs (Vehicle Power and Bluetooth) both flash on and off when the Scan Module and diagnostic tool are actively communicating through a wireless connection. The red Communication LED flashes on and off when the Scan Module is performing an internal self test, and is illuminated continuously if a failure is detected ([Figure 5-6](#)).

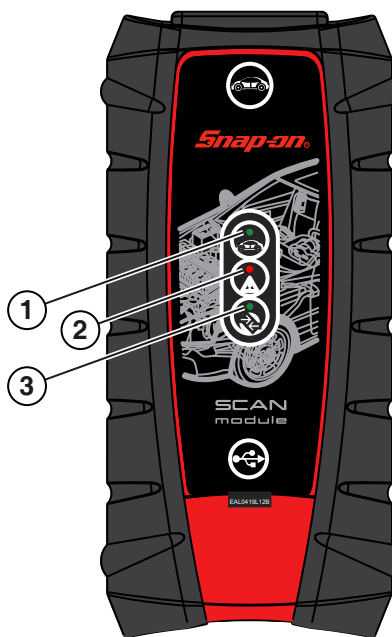

- 1— Vehicle Power—green LED, flashes during wireless communications**
- 2— Communication—red LED, illuminates if there is a communications failure**
- 3— Bluetooth—green LED, flashes during wireless communications**

Figure 5-6 Scan Module LEDs

Each LED can be in one of three states; off, lit solid, or flashing. Interpret as follows:

- Vehicle Power
 - Off, vehicle power is not being supplied to the Scan Module through the data cable
 - On Solid, the Scan Module is being powered by the vehicle, but not communicating with the Diagnostic Tool.
 - Flashing, the Scan Module is being powered by the vehicle and is communicating with the Diagnostic Tool.
- Communication
 - Off, normal state, no errors detected.
 - On Solid, communications error detected.
 - Flashing, internal self-test in process, will go out once the test completes.
- Bluetooth
 - Off, there is no connection between the Scan Module and Diagnostic Tool.
 - On Solid, the Scan Module and Diagnostic Tool are communicating through a solid (USB cable) connection.
 - Flashing, the Scan Module and Diagnostic Tool are communicating through a wireless connection.

5.5.4 Recovery Procedure

This is a quick and easy method that reestablishes connectivity between the diagnostic tool and the Scan Module in most instances. If bluetooth connectivity remains unavailable following recovery, use one of the alternate procedures to restart the system.

**NOTE:**

This product is intended to be used by professional technicians in a garage environment. Electrostatic discharges may happen occasionally and cause a loss of communication. To restore communication disconnect and reconnect the communication cables and follow screen prompts.

**To recover wireless connectivity:**

1. Disconnect the Scan Module from the vehicle.
2. Navigate to the Home Screen on the diagnostic tool.
3. Select **Exit** to close the ShopStream Diagnostic Suite.
4. Connect the Scan Module to the vehicle.
5. Select the **ShopStream Diagnostic Suite** icon on the desktop.



Figure 5-7 Sample ShopStream Diagnostic Suite desktop icon

**NOTE:**

The ShopStream Diagnostic Suite can also be started from the Windows Start menu.

Alternate Recovery Procedures

Use these methods as an option to the Recovery Procedure, or when recovery fails to restore the wireless connection.

USB Procedure

This method establishes a “hard-wired” USB cable connection between the modules.

**To create a USB connection:**

1. Carefully slip the ends of the handgrip off of the sides of the Scan Module housing.
2. Lift open the hinged cover on the base of the Scan Module.

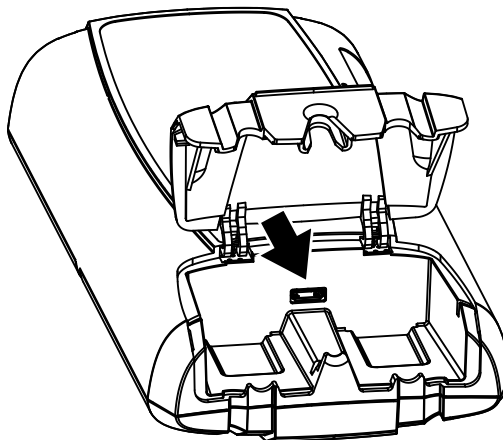

Figure 5-8 Scan Module USB jack, handgrip removed

3. Plug the small end of the USB cable into the USB jack on the Scan Module.
4. Plug the large end of the USB cable into a USB jack on the diagnostic tool.
Scanner functionality should be restored immediately once the USB connection is complete. If not, suspect a hardware failure. The diagnostic tool and Scan Module are both fully functional, so you can complete your testing with the USB connection intact.

ShopStream Diagnostic Suite Restart Procedure

This method, which closes and restarts the ShopStream Diagnostic Suite software, takes about two minutes to complete.



To restart the ShopStream Diagnostic Suite:

1. Navigate to the Home Screen on the diagnostic tool.
2. Select **Exit** to close the ShopStream Diagnostic Suite.
3. Wait for the Scan Module Communication LED to stop flashing.
4. Select the ShopStream Diagnostic Suite icon on the desktop.
The ShopStream Diagnostic Suite should open with connectivity restored.

Windows Reboot Procedure

This method, which completely shuts down the diagnostic tool, takes several minutes to complete.



To reboot the diagnostic tool:

1. Disconnect the Scan Module from the vehicle.
2. Navigate to the Home Screen on the diagnostic tool.
3. Select **Exit** to close the ShopStream Diagnostic Suite.
4. Select **Start** in the lower-left corner of the screen to open the menu.
5. Select **Turn Off Computer** from the menu.
6. Select **Turn Off** when the Confirmation window opens.
7. Wait for the tool to completely turn off, then press the **Power** button to restart the diagnostic tool.
8. Connect the Scan Module to the vehicle once the ShopStream Diagnostic Suite opens.

5.6 Updating Scan Module Firmware

The internal programming (firmware) of the Scan Module, may require periodic updates. These firmware updates (when available) are delivered with diagnostic software updates/upgrades. Firmware updates increase the Scan Module's diagnostic capabilities, typically by adding support for new tests, vehicles and enhanced applications to the vehicle databases.



Scan Module Firmware Update Process:

Upon starting the Scanner function, initially after a software update or upgrade has been installed, a message may be displayed to inform you an update is available ([Figure 5-9](#)).

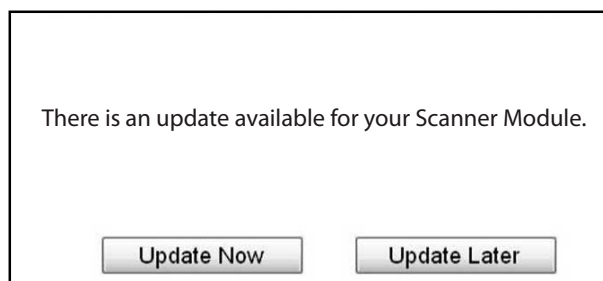

Figure 5-9 Scan Module update available message

IMPORTANT:

To supply power to the Scan Module, the data cable must be connected to the vehicle during the update process, with the vehicle ignition switch in the OFF position. To avoid damaging the Scan Module, never turn the ignition switch ON during the update process.

IMPORTANT:

To avoid damaging the diagnostic tool or scan module, it is highly recommended to connect the AC/DC power supply to the diagnostic tool before starting the firmware update process. Damage can occur to the scan module if the diagnostic tool power is turned off or the power supply is disconnected during the firmware update process.

1. Select the desired update option:
 - **Update Now** begins the process immediately.
 - **Update Later** defers the operation, closes the message, and starts the Scanner function. If you choose not to perform the update, it will not affect diagnostic tool operation, however you will not benefit from the additional features available in the update.
-



NOTE:

Selecting **Details** in the upper-right corner opens a list of what is included in the update.

Once the update process has been started, the update is performed wirelessly, and the installation progress is tracked on the screen ([Figure 5-10](#)).

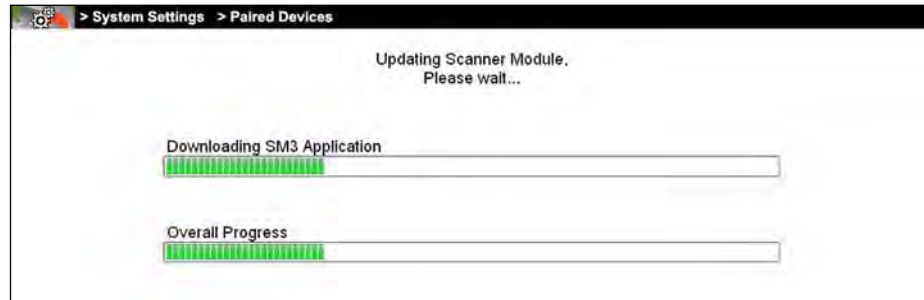

Figure 5-10 Sample update in progress screen

A “successfully updated” message displays once the installation process is complete (Figure 5-11).



Figure 5-11 Sample firmware update complete message

2. Select **OK** to close the message and return to Scanner operations.
The updated Scan Module, is ready to use.



Alternate Scan Module Firmware Update Process (USB cable):

If necessary, this alternate firmware update procedure may be used to update the Scan Module firmware.

IMPORTANT:

The diagnostic tool must be connected and powered by the AC/DC power supply during the Scan Module firmware update process. Damage can occur to the Scan Module if the diagnostic tool power is turned off or the power supply is disconnected during the firmware update process.

1. Connect the AC/DC power supply to the diagnostic tool.
2. Turn on the diagnostic tool.
3. Connect the Scan Module to the diagnostic tool as follows:

IMPORTANT:

The Scan Module data cable must be disconnected from the vehicle during the update process.

- a. From the bottom of the Scan Module, gently lift up and out on the sides of the handgrip to free it from housing (Figure 5-12).
- b. Open the hinged cover on the base of the Scan Module to expose the USB jack.
- c. Plug the small end of the USB cable into the USB jack on the Scan Module.
- d. Plug the large end of the USB cable into one of the USB jacks on the side of the diagnostic tool.

**NOTE:**

When connected, the scan module USB connection status icon background color will change from gray to green.

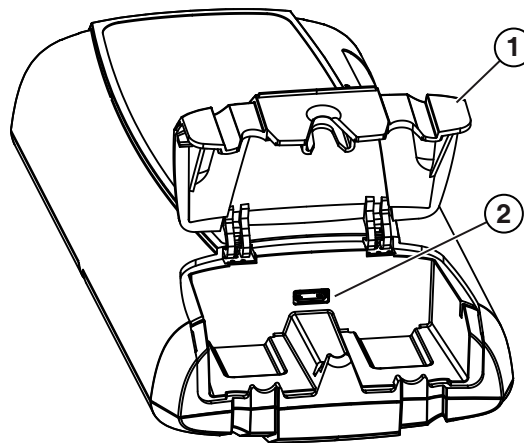

1— Hinged cover

2— USB jack

Figure 5-12 Scan Module USB jack

4. Select **Scanner** from the diagnostic tool Home screen.
5. Select **OK** when the update available message displays.
The update begins and installation progress is tracked on the screen (Figure 5-13).

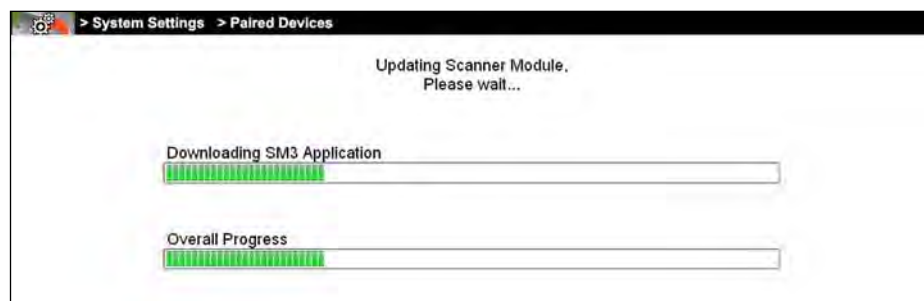

Figure 5-13 Sample update in progress screen

A “successfully updated” message displays once the installation process is complete (Figure 5-14).

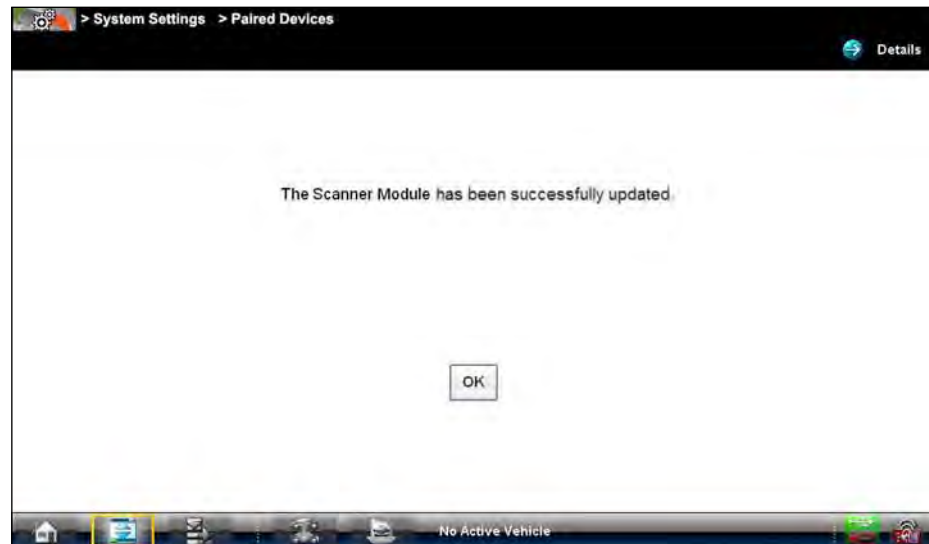

Figure 5-14 Firmware update complete message

6. Select **OK** to close the message and return to the Scanner function. The updated Scan Module, is ready to use.

This Home screen option allows you to access Generic OBD-II/EOBD Scanner tests without completing a vehicle identification. OBD Direct presents a quick way to check for diagnostic trouble codes (DTCs), isolate the cause of an illuminated malfunction indicator lamp (MIL), check monitor status prior to emissions certification testing, verify repairs, and perform a number of other services that are emissions-related. This mode is also used for testing OBD-II/EOBD compliant vehicles that are not included in the Scanner databases.

OBD Direct is a Scanner function, and the Scan Module must be connected to the test vehicle and communicating with the diagnostic tool. This function only provides generic OBD-II/EOBD information. To access enhanced OBD-II/EOBD functions, select Scanner from the Home screen.

Options for the Menu icon on the Toolbar at the base of the screen are the same as those available for the Scanner module.

Selecting OBD Direct on the Home screen opens a menu with two options ([Figure 6-1](#)):

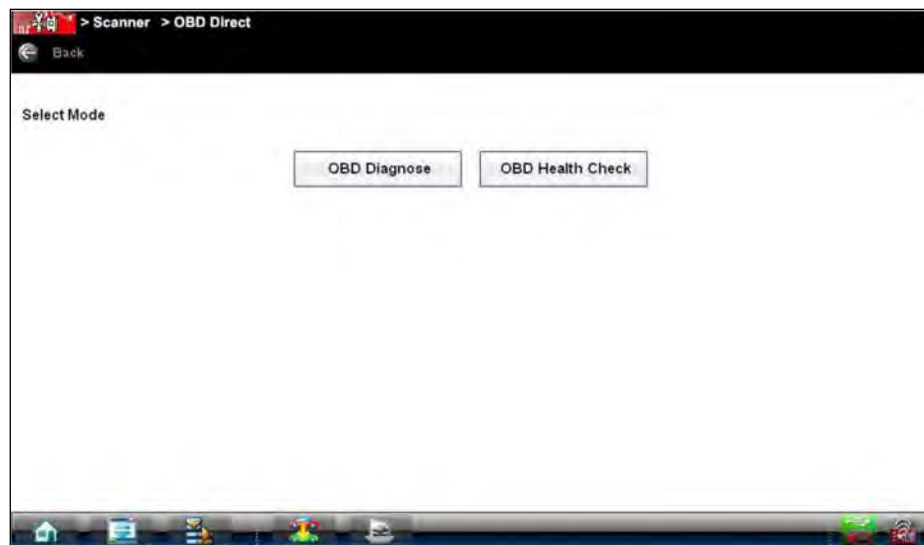

Figure 6-1 Sample OBD Direct main menu

6.1 OBDDirect Health Check

The OBDDirect Health Check offers a way to quickly check for and clear generic diagnostic trouble codes (DTCs) and to check readiness monitors. Selecting OBDDirect Health Check opens a submenu of options (Figure 6-2).

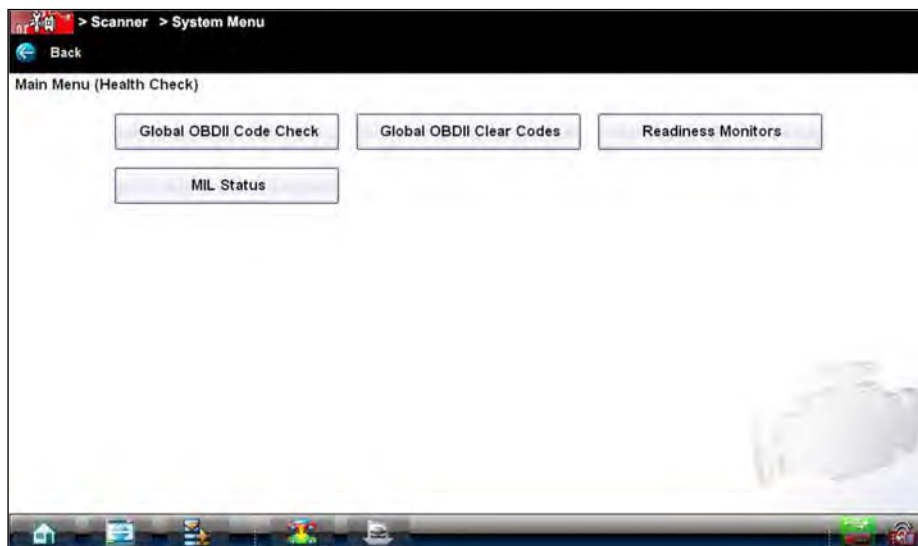

Figure 6-2 Sample OBDDirect Health Check menu

6.1.1 Global OBD II Code Check

This option displays any stored emission related generic DTCs reported by the ECM. Selecting opens a submenu with two choices:

- Codes
- Pending Codes

Codes

Codes displays a list of current emission related DTCs. OBD-II/EOBD Codes have a priority according to their emission severity, with higher priority codes overwriting lower priority codes. The priority of the code determines the illumination of the MIL and the code erase procedure. Manufacturers rank codes differently, so expect to see differences between makes.

Pending Codes

The purpose of this service is to enable the scan tool to obtain “pending” or maturing diagnostic trouble codes. These are codes whose setting conditions were met during the last drive cycle, but need to be met on two or more consecutive drive cycles before the DTC actually sets.

The intended use of this service is to assist the service technician after a vehicle repair and after clearing diagnostic information, by reporting test results after a single driving cycle.

- If a test failed during the driving cycle, the DTC associated with that test is reported. If the pending fault does not occur again within 40 to 80 warm-up cycles, the fault is automatically cleared from memory.
- Test results reported by this service do not necessarily indicate a faulty component or system. If test results indicate another failure after additional driving, then a DTC is set to indicate a faulty component or system, and the MIL is illuminated.

6.1.2 Global OBDDirect II Clear Codes

This option is used to clear all emission related diagnostic data such as, DTC records, freeze frame data, and test results, from ECM memory. Although OBDDirect only displays generic OBDDirect-II data, clearing codes erases all of the stored data including any enhanced codes.

A confirmation screen displays when the clear codes option is selected to prevent accidental loss of data. Select **Yes** on the confirmation screen to continue.

6.1.3 Readiness Monitors

Use this menu option to check the readiness of the monitoring system. An OBDDirect-II/EOBD system checks the status of emission-related subsystems by running continuous or periodic tests. Test results are shown in the data viewer (Figure 6-3).

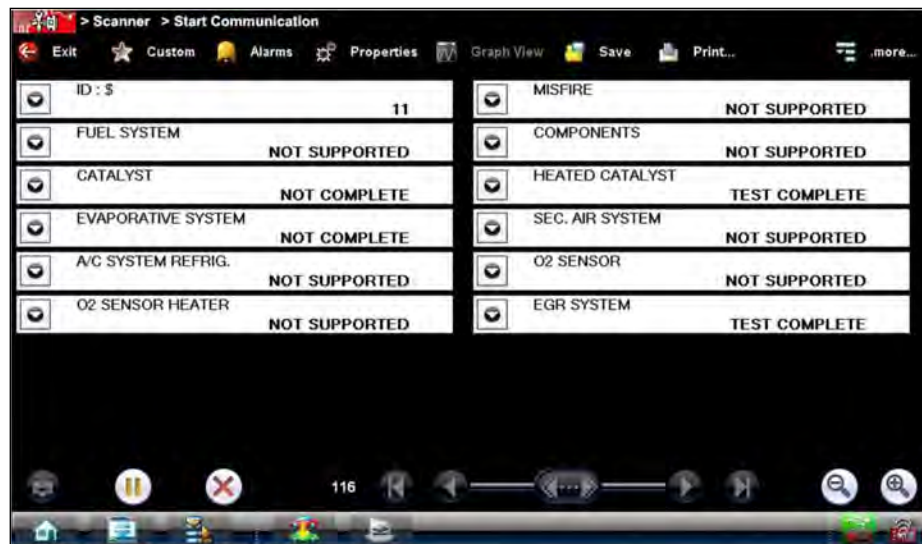

Figure 6-3 Sample readiness monitor test report

Gesture sweep to view the entire list of Readiness Monitors to ensure that all tests are complete. It is possible to print the readiness test status or save it as part of a Vehicle history.

6.1.4 MIL Status

This item is used to check the current condition of the malfunction indicator lamp (MIL). Additional information, such as which ECM commanded the MIL on and the distance driven while the MIL is on (if supported), can also be displayed. It is also possible to print the MIL Status.

6.2 OBD Diagnose

Selecting OBD Diagnose opens a menu with the following options:

- Start Communication—begins the test session
- Connector Information—provides data link connector (DLC) location details for most models
- Manual Protocol Selection—allows you to select which protocol to use

6.2.1 Start Communication

Use the following procedure to conduct an OBD Direct test session:



To perform an OBD Direct Test:

1. Select **Start Communications** from the OBD Direct menu.

A generic connection message displays ([Figure 6-4](#)), connect the Scan Module to the test vehicle as instructed.

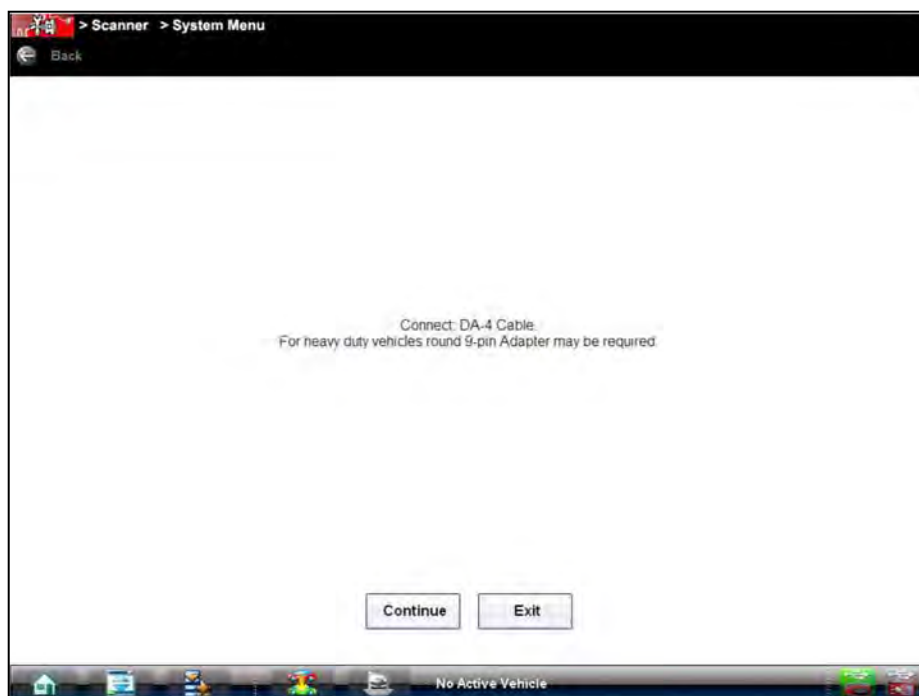

Figure 6-4 Sample generic connection message

2. Select **Continue**.

A communications message that shows how many ECMs were detected, which ECM is communicating, and which communication protocol is being used displays (Figure 6-5).

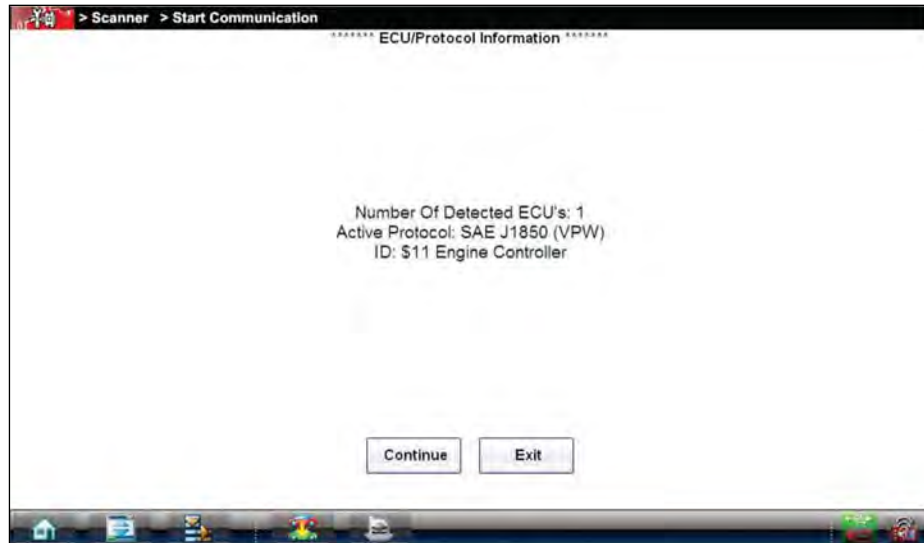

Figure 6-5 Sample communication message

3. Select **Continue** and a menu of available tests displays (Figure 6-6).

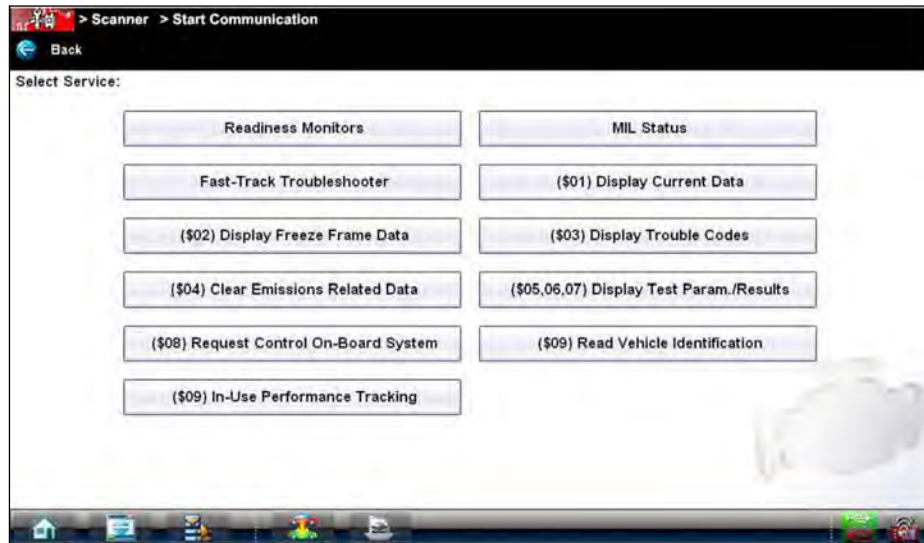

Figure 6-6 Sample Start Communication menu

4. Select a test to continue.

Readiness Monitors

Use this menu item to check the status of the monitored system. If a monitored system is not supported, it is not displayed. Scroll, if needed, to view the entire list of monitors. Selecting Readiness Monitors opens a submenu with two choices:

- **Monitors Complete Since DTC Cleared**—displays the results of all monitor tests that have run since the last time the electronic control module (ECM) memory was cleared.
- **Monitors Complete This Cycle**—displays only the results of monitor tests that ran during the current drive cycle, they reset when the ignition is switched off.

MIL Status

This item is used to check the current condition of the malfunction indicator lamp (MIL). Additional information, such as which ECM commanded the MIL on and also the distance traveled while the MIL is on (if supported), can also be displayed. It is also possible to print the MIL Status.

Fast-Track Troubleshooter

Fast-Track® Troubleshooter is a database of experience-based information of validated real-world repair strategies that have been compiled by top-notch technicians since 1988. The Troubleshooter system simplifies the diagnosis process, as it contains information on virtually all common diagnostic trouble code (DTC) problems and driveability symptoms for most vehicles covered by the vehicle communication software.

(\$01) Display Current Data

Use this item to display the current emission related data from the selected electronic control module (ECM) of the vehicle. Displayed data includes analog inputs and outputs, digital inputs and outputs, and system status information broadcast on the vehicle data stream. OBD Direct data displays similar to Scanner data, refer to [Data Display](#) on page 56 for details.

(\$02) Display Freeze Frame Data

This item is used to display freeze frame data for any stored emission related diagnostic trouble codes (DTC). In most cases the stored frame is the last DTC that occurred. Certain DTCs, those that have a greater impact on vehicle emission, have a higher priority. In these cases, the highest priority DTC is the one for which the freeze frame records are retained.

Freeze frame data includes a “snapshot” of critical parameter values at the time the DTC set.

(\$03) Display Trouble Codes

This option displays any stored emission related DTCs reported by the various ECMs. The OBD Direct code report is similar to a Scanner module code report, and includes the **Fix It!** icon with hyperlinks to Information details. See [Display Codes](#) on page 54 for additional information.

(\$04) Clear Emissions Related Data

This item is used to clear all emission related diagnostic data such as, DTCs, freeze frame data, and test results from the memory of the selected ECM.

(\$05, 06, 07) Display Test param./Results

This option opens a submenu of test parameters and test results from various sensors, monitor test results, and a record of DTCs detected during the last drive cycle. The menu includes:

- Oxygen Sensor Monitoring (\$05)
- On-Board Monitored Systems (\$06)
- DTCs Detected During Last Drive (\$07)

(\$08) Request Control of On-board System

This service enables bidirectional control of the ECM so that the Scanner is able to transmit control commands to operate the vehicle system. This function is useful in determining how well the ECM responds to a command.

Available options vary by make, model, and year of the test vehicle. Select a test and follow the on-screen instructions.

(\$09) Read Vehicle Identification

This selection displays the vehicle identification number (VIN), the calibration identification, and the calibration verification number (CVN) of the test vehicle.

(\$09) In-use Performance Tracking

This selection displays the “In-use Performance Tracking” of monitored data. It is basically a record of the number of times each of the monitor tests have been completed.

(\$0A) Emission Related DTC with Permanent Status

This service displays a record of any “permanent” codes on late-model vehicles if the vehicle supports Service \$0A. A permanent status DTC is one that was severe enough to illuminate the MIL at some point, but the MIL may not be on at the present time.

Whether the MIL was switched off by clearing codes or because the setting conditions did not repeat after a specified number of drive cycles, a record of the DTC is retained by the ECM. Permanent status codes automatically clear after repairs have been made and the related system monitor runs successfully.

6.2.2 Connector Information

This option opens a database of vehicle diagnostic connector locations that includes most makes and models.



To locate a vehicle diagnostic connector:

1. Select **Connector Information** from the System menu.
2. Select a manufacturer from the list presented.
3. Select a model from the list presented.
Instructions for which, if any, cable adapter or pin to use displays.
4. Select **Continue**.
Information on where to locate the vehicle diagnostic connector displays.
5. Select **Continue** to return to the System menu.

6.2.3 Manual Protocol Selection

A communication protocol is a standardized way of data communication between an ECM and a scan tool. Global OBD may use several different communication protocols. The scan tool automatically connects to an available protocol, which displays on the connection message (Figure 6-5). Some vehicles communicate on more than one protocol. Use the Manual Protocol Selection option to switch to a different protocol.

Select **Manual Protocol Selection** and message displays advising you to make sure you know the correct protocol for the test vehicle. An incorrect selection may activate warning lamps and set CAN related faults on the vehicle. Select **OK** and a menu of options displays (Figure 6-7).

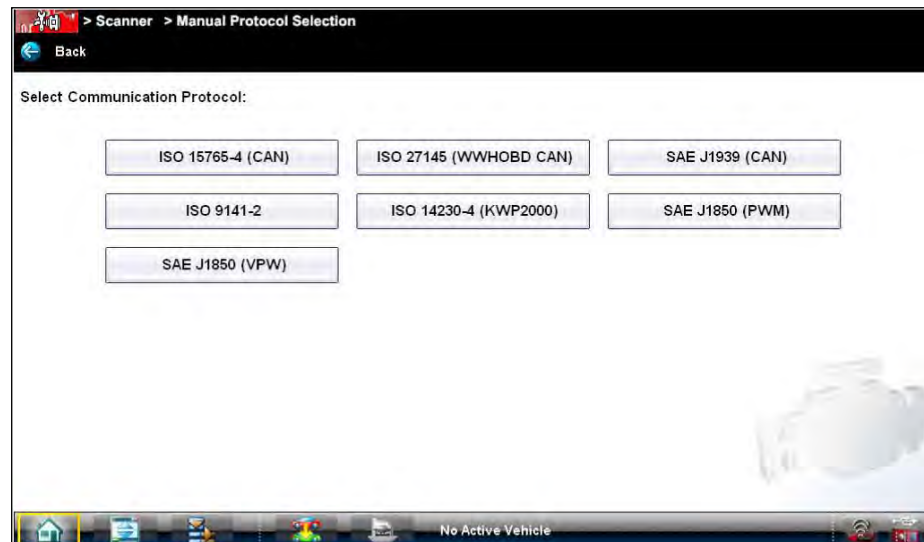

Figure 6-7 Sample communication protocol menu

Guided Component Test Operations

The Guided Component Test software is a component-testing powerhouse, providing you with a robust diagnostic database for use with scopes and meters. It is like having access to a complete library of shop manuals for testing engine-management components, transmission sensors and components, and ABS systems.

Guided Component Test helps you with everything from selecting the appropriate test for a specific component to showing the hook-up location and correct pin configuration. This software thoroughly guides and instructs you on proper testing procedures and offers tips from the internal troubleshooter database. The Guided component test procedures, tips, and meter settings reduce your overall set-up and diagnostic testing time. Vehicle-specific guided component tests are provided for engine, transmission, ABS, charging, transfer case and suspension systems.

WARNING



Risk of electrical shock.

- **Read the *Important Safety Instructions* document provided separately for messages on the safe use of this product.**
- **This product is intended for Measurement Category I (for example, automotive 12V systems), do not use this product for Measurement Categories II, III, and IV.**
- **Measurement Category I is for performing measurements on circuits not directly connected to MAINS or MAINS circuits (an example of a MAINS circuit is 120V AC or 240V AC household or industrial electricity), do not connect this product to MAINS or MAINS circuits.**
- **Do not apply the Black Ground Lead to test points other than ground/system return/ vehicle chassis.**

Electrical shock can cause personal injury, equipment damage, or circuit damage.

IMPORTANT:

Maximum rated transient over voltage impulse is 500 volts, do not exceed the rated transient over voltage.

7.1 Vehicle Identification

The Guided component test information presented is specific to the vehicle being tested. Therefore, certain attributes of the test vehicle must be entered into the diagnostic tool so that the correct data can be retrieved. Vehicle identification information is carried over if you enter the Guided Component Test module either from the Scanner function or from one of the records stored in the Vehicle History module. However, you may need to enter additional attributes in some instances.

The vehicle identification sequence is menu driven, you simply follow the screen prompts and make a series of choices. Each selection you make advances you to the next screen.

7.1.1 Menu Options, Guided Component Test

Selecting the Toolbar Menu icon at the base of the screen offers the following options:

- [Safety Information](#)—opens the *Important Safety Instructions* document.
- [File](#)—allows you to print or save the data being viewed.
- [Help Operations](#)—allows you to view supporting documentation.

File

Selecting **File** opens a menu of print options:

- **Print Article**—selecting has one of two results:
 - If a printer is connected, the file is sent to the printer.
 - If a printer is not connected, the article is saved as a (.xps) file, which can be retrieved, moved, or copied and printed at a later time.
- **Print Preview**—opens a representation of what the printed file will look like.
- **Page Setup**—allows you to adjust margins and paper orientation.

7.1.2 Creating a Favorites List

Once a Guided Component Test database is loaded, a list of manufacturers displays. This list is often long and includes makes that are not frequently used. A toolbar at the top of the screen allows you to custom configure the manufacturer list to display only the makes you frequently service.

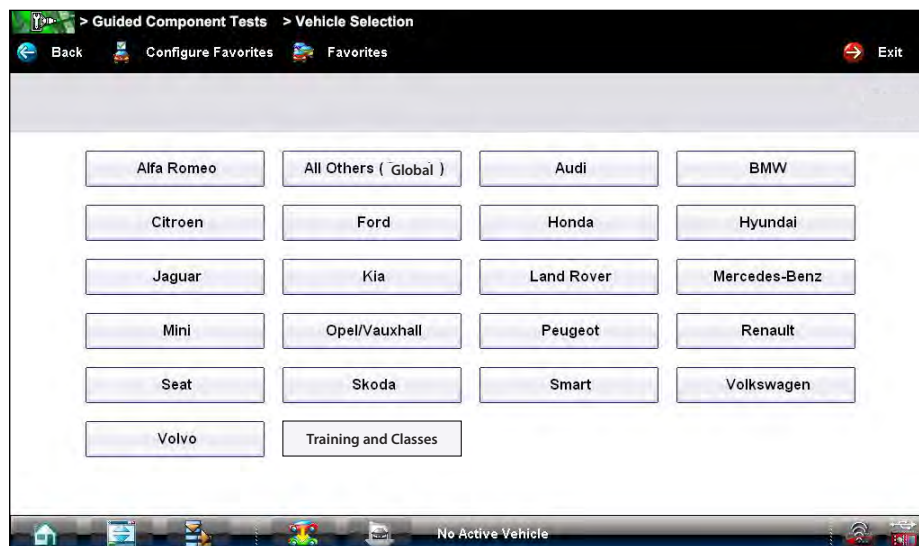

Figure 7-1 Sample manufacturer list



To configure a favorites list:

1. Select **Configure Favorites** on the toolbar.
A list of selectable manufacturers displays.

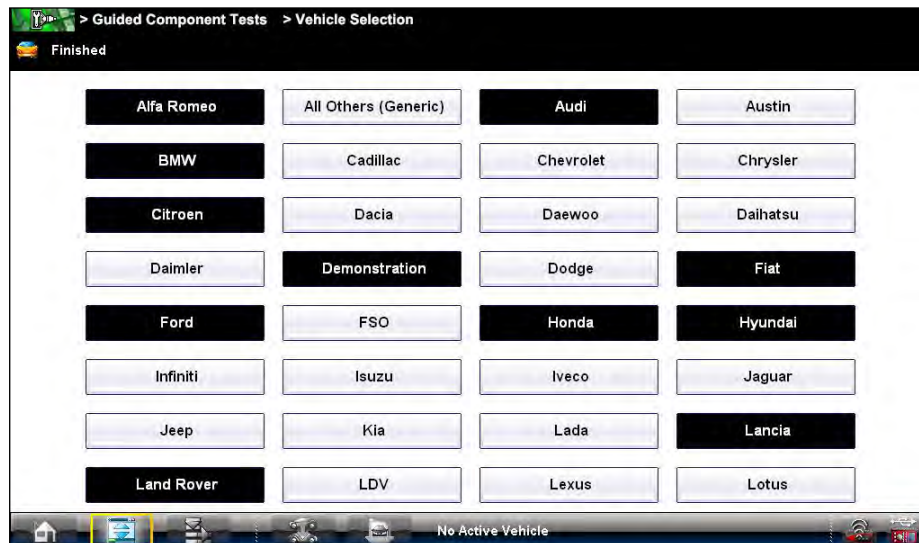

Figure 7-2 Sample Configure Favorites screen

2. Select each manufacturer you want to include, selected manufacturers are highlighted.



NOTE:

Manufacturers appear on the favorites list in the order in which they are selected. Therefore, if you select the makes you work on most frequently first, they will appear at the top of the list.

3. Select **Finished** on the toolbar once your selections have been made.
The screen returns to the manufacturer list, but only the makes you selected display. Note the "Favorites" toolbar selection now reads "Full list".
4. Select **Full List** on the toolbar to view the complete list of manufacturers.
5. Select **Back** on the toolbar at any time to return to the previous screen.

Your favorites list is what will display whenever a Guided Component Test database is started in the future. The list can be modified at any time by selecting Configure Favorites from the toolbar.

7.1.3 Identifying a Test Vehicle

Exact procedures to identify the test vehicle may vary somewhat by vehicle and market. The following procedure, which identifies a 2008 Ford Focus for testing the fuel injection system, is typical of what to expect.



To identify a vehicle for Guided Component Test:

1. Select the **Guided Component Test** Function icon from the Home screen.
2. Select which database to load for the test vehicle if requested (optional).
After the database loads, a list of manufacturers displays.

3. Select **FORD** and a model year menu displays.
4. Select **2008** from the year menu and a list of available models displays.
5. Select **FOCUS** from the model list and a list of available engines displays.
6. Select **1.6L** from the engine list and a confirmation dialog box displays (Figure 7-3).



Figure 7-3 Sample confirmation dialog box

7. From the confirmation dialog box, select **OK** to continue, or **Cancel** to return to the engine list. A list of tests available for the identified vehicle displays (Figure 7-4).

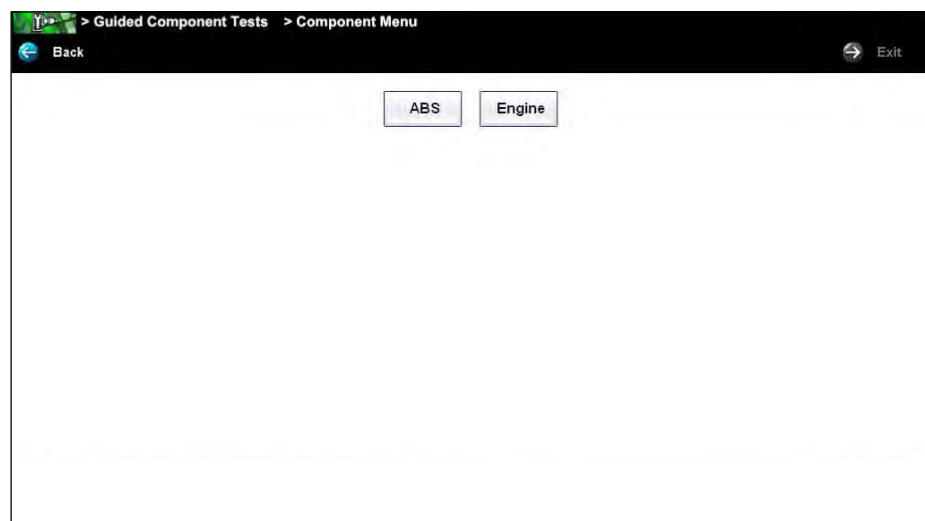

Figure 7-4 Sample available tests list

- Select **ENGINE** and a component test menu displays (Figure 7-5).

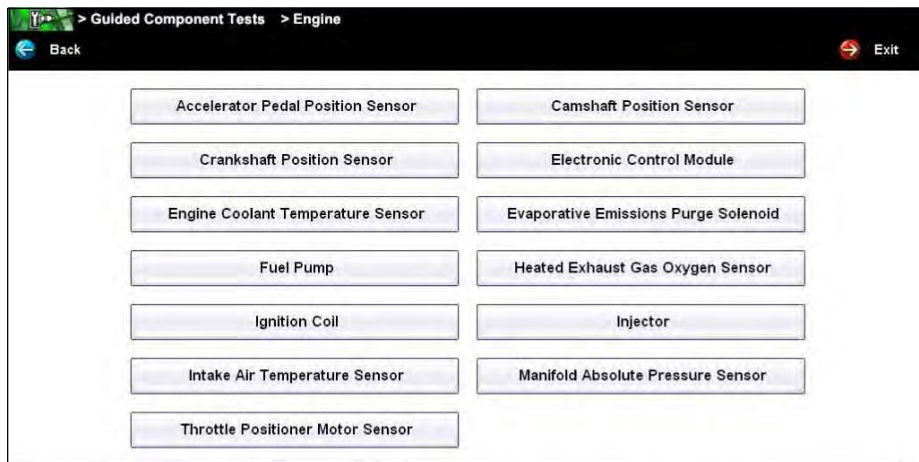

Figure 7-5 Sample available component tests list

- Select a test to continue.

The identification sequence is now complete, refer to the Operations section that follows for details on how to navigate through the Guided Component Test information and perform tests.



NOTE:

If you return to the Home screen and select **Scanner** or **Vehicle History** the vehicle identification entered here is carried over. However, additional information may be needed by some modules.

7.2 Training and Classes

Training and Classes is a companion feature to the Guided Component Tests function, and can be selected from the vehicle make menu.

This resource includes a wide collection of common (non-vehicle specific) reference information and tests, such as measuring fuel pump current ramp, and monitoring CKP and CMP signals simultaneously. Also included are; basic component operation and theory information, testing procedures, tips, definitions, illustrations, diagnostic tool feature descriptions, and accessory information.

Selecting Training and Classes opens a list that may include the following options:

- [Features Benefits](#)
- [Power User Tests](#)
- [How To](#)

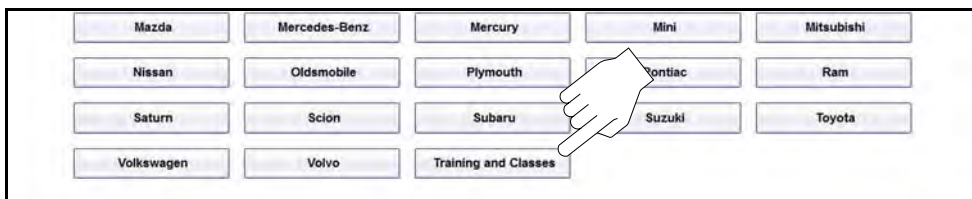

Figure 7-6

7.2.1 Features Benefits

Selecting **Features Benefits** opens a menu page that includes:

- **5-Minute Walk Thru With Demo Board (Australia Only)**—explains how to use the optional demonstration board to generate sample signals.
- **Accessories**—opens a menu of optional equipment available.
- **Product Description**—provides descriptions and a brief overview of meter operations.

The demonstration board not only helps you learn how to use the Guided Component Tests software, it allows you to hone your skills and diagnostic technique without an actual test vehicle.

7.2.2 Power User Tests

The **Power User Tests** option gives you quick access to a pre-configured meter for conducting a number of control system tests. Tests are available with or without on-screen help. Help typically provides a description of the test along with expected results and a link to the pre-set meter.

7.2.3 How To

The **How To** option provides a list of available on-screen instructions for performing tasks. Scroll to view the entire list. Typical topics include:

- **10-Minute Electronic Class**—provides brief instruction in basic electronics and circuit connections.
- **15-Minute Ignition Class**—provides an introduction to basic ignition testing.
- **Illustrated Terms & Definitions**—provides definitions of terms, drawings and tips associated with guided component testing.
- **No-start Basics**—provides a guideline for diagnosing a no-start condition.
- **O2 Sensor & Feedback System Analysis**—displays the guided component test meter in the “live” graphing mode with O2S test tips to help you understand the fundamental concepts of O2S diagnostics.
- **Test Tips**—gives on-screen instructions for performing specific guided component tests along with drawings and tips.
- **20-minute Current Ramp Classes**—provides an introduction to current ramp testing.

7.3 Operations

The Guided Component Test software provides vehicle specific guided component test procedures and information that aid in setting up scopes and meters. Once a test vehicle is identified, you can select a guided component test from the list of available tests. For most selections two main choices are available on the component menu:

1. **COMPONENT INFORMATION**—provides information on the selected component and connector pin details that assists you in understanding the components prior to diagnosis.
2. **TESTS**—provides a pre-configured list of tests, guides you through performing the tests, and offers tips and resources to reduce setup and testing time.

7.3.1 Component Information

Component Information provides details on specific vehicle components to provide a better understanding of the components prior to diagnosis.

The Component Information screens contain information to assist you with testing. The screens are divided in sections to help quickly guide you to the correct information (Figure 7-7):

- **Operation**—provides a general description of normal component operation.
- **Connector**—displays the component connector and lists pin assignments.
- **Location**—identifies the component location and the best place for testing it.
- **Tech note**—provides guided component test-related tips (for example, common failures or faults) as well as update or recall information.

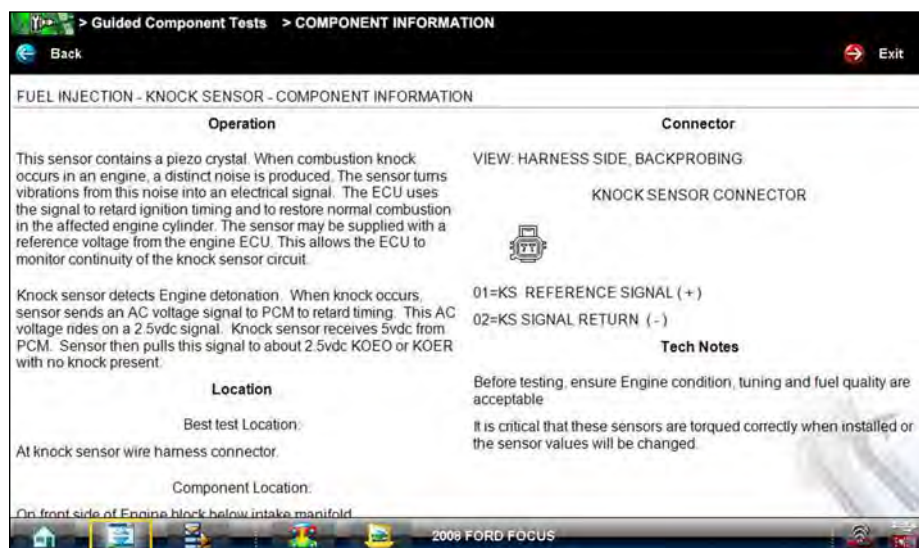

Figure 7-7 Sample Component Information screen



To view component information:

1. Select a component from the tests list.
2. Select **COMPONENT INFORMATION** from the component menu.



NOTE:

An additional selection, such as front or rear for an oxygen sensor (O2S), may be required before advancing to the component information screen.

The component information screen displays (Figure 7-7).

3. Always Gesture sweep to view any additional information below what is visible.
4. Select **Back** at any time to return to the previous screen.

7.3.2 Tests

The Tests section guides you through the process of performing tests on a specific component. It also provides specifications, tips on how and where to connect the test meter leads, and also automatically configures the multimeter or lab scope to perform the selected test.

Once a test vehicle is identified, you can select a component from the available tests list.



To select a test:

1. Select a component from the list.
2. Select **TEST** to open the list.



NOTE:

More than one selection is available in some instances. For example, select Ignition Tests and a menu offering Primary Tests and a Secondary Tests displays.

The list shows all of the tests available for the selected component, choices vary by make, model, and year.

Selecting opens an additional submenu similar to the one shown in [Figure 7-8](#) when more than one option is available.

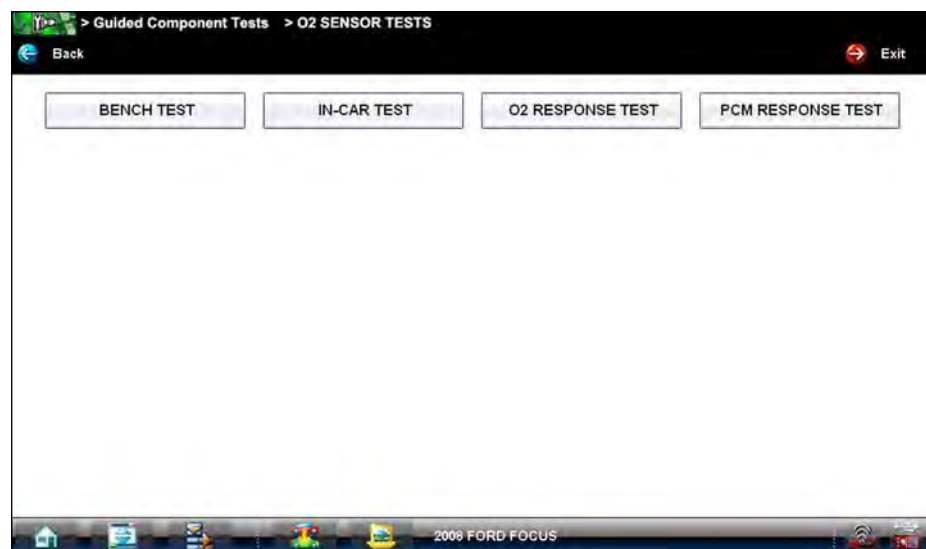

Figure 7-8 Sample O2S voltage test submenu

3. Select a test option and the test screen displays ([Figure 7-9](#)).

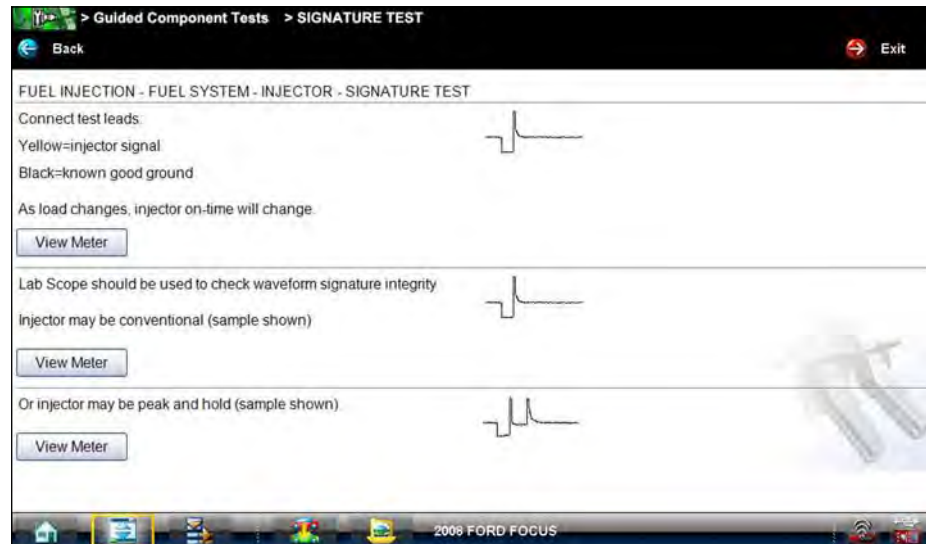

Figure 7-9 Sample Test screen

4. Gesture sweep to view any additional information.
5. Select **Back** at any time to return to the previous screen, or select **Exit** to return to the main component menu.

Hyperlinks

Guided component test screens contain hyperlinks that can either take you to another page containing additional information or open an additional window on top of the current screen. Hyperlinks display as icons. Common hyperlinks are:

- **View Meter**—opens a live meter set up to perform the test in the lower portion of the screen (Figure 7-10). Once the meter view is open, the Guided Component Test toolbar at the top of the screen is replaced by the Scope Multimeter toolbar, which allows you to make adjustments to the settings. See [Scope Multimeter Toolbar](#) on page 106 for details.
- **Show More Information**—advances to a new screen with more detailed information about a particular test, select **Back** to return to the test screen.

View Meter

A Meter icon, which is only available in the Guided Component Test view meter mode, appears on the upper toolbar (Figure 7-10).

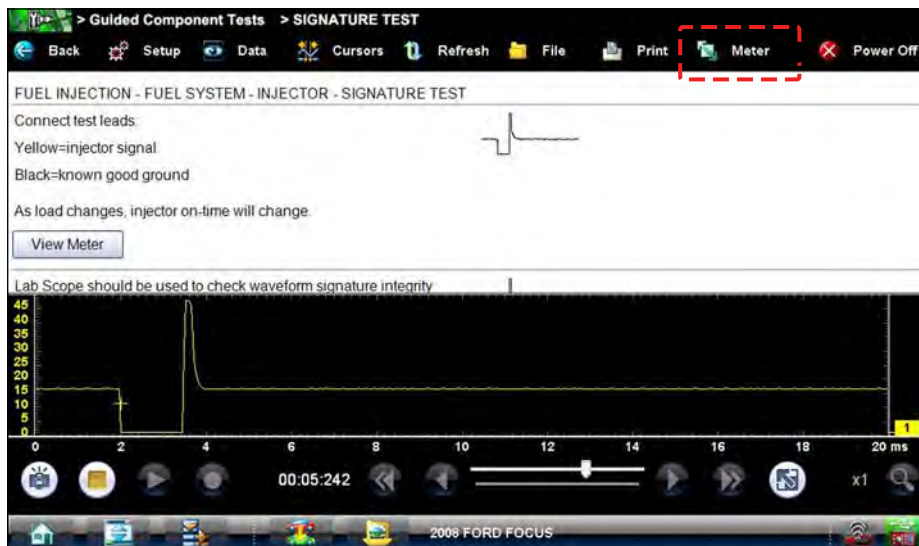

Figure 7-10 Sample view meter window

Three view meter options are available:

1. With View Meter active (Figure 7-10), select the **Meter** icon on the toolbar once and the meter expands to fill the entire screen.
2. Select the **Meter** icon a second time and the meter open as a separate window (Figure 7-11). This window can remain open if you switch to the Scanner function and can be accessed from the Windows toolbar at the bottom of the screen. You can also resize and reposition the meter window on the screen.

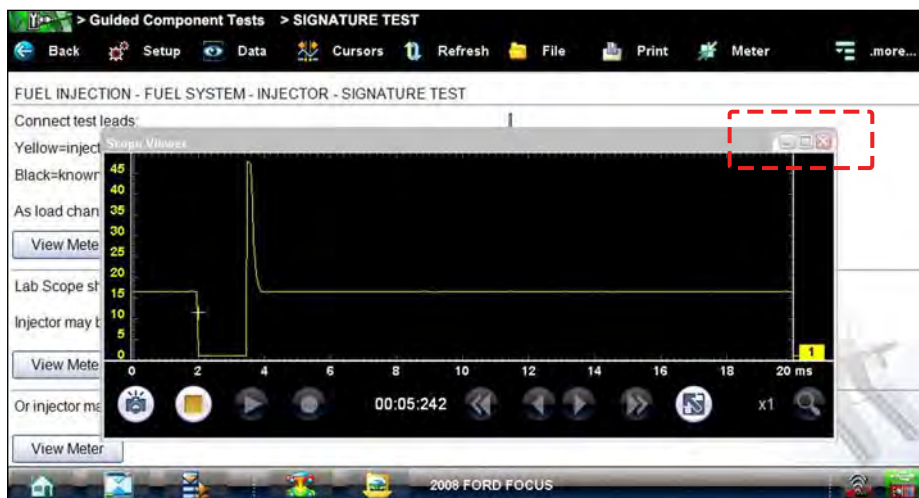

Figure 7-11 Sample meter view in a separate window

Selecting the **Close** icon (red box with an X) when viewing the meter in a separate window closes the meter and returns you to the Guided Component Test screen.

3. Select the **Meter** icon a third time to close the separate window and return to the standard meter view as shown in Figure 7-10.

Select **Exit** from the toolbar to close meter view and return to the Guided Component Test screen.

Connecting to a Test Vehicle

Before performing a test, you must connect the meter test leads to the vehicle. Certain guided component tests require the use of specific leads. Information on specific leads and other connecting information displays on the initial test screen. Follow the on-screen connection instructions in the test procedure to connect the test leads.

Performing a Test

Once you connect the test leads to the vehicle, you can proceed with testing.



To perform guided component tests:

1. Follow the instructions displayed in the test procedure section.
2. Gesture sweep to view all of the instructions and follow the on-screen procedures.
3. Select the View Meter hyperlink to display test results.
4. Refer to the on-screen information to verify test results.

Scope and Multimeter Operations

The Scope Multimeter function provides all the tools needed for performing electrical and electronic circuit tests and for monitoring signals and circuit activity. The Scope Module easily separates from the Diagnostic Tool and connects with a USB cable so that test results can be remotely monitored as you perform other tasks.

The Scope Multimeter function works interactively with other functions. Selecting “View Meter” from a Guided Component Test or Scanner Test opens the Scope Multimeter function.

WARNING



Risk of electrical shock.

- **Read the Safety Information provided for important warnings on the use of this product**
- **This product is intended for Measurement Category I (for example, automotive 12V systems), do not use this product for Measurement Categories II, III, and IV.**
- **Measurement Category I is for performing measurements on circuits not directly connected to MAINS or MAINS circuits (an example of a MAINS circuit is 120V AC or 240V AC household or industrial electricity), do not connect this product to MAINS or MAINS circuits.**
- **Do not apply the Black Ground Lead to test points other than ground/system return/ vehicle chassis.**

Electrical shock can cause personal injury, equipment damage, or circuit damage.

IMPORTANT:

Maximum rated transient over voltage impulse is 500 volts, do not exceed the rated transient over voltage.

8.1 Using the Scope Module Remotely

The Scope Module (M4) module can be undocked from the Diagnostic Tool, and used remotely to increase the range of mobility while monitoring signals on a test vehicle. An A/B type USB cable (supplied) is used to connect the Scope Module to the Diagnostic Tool when used remotely.

As general practice, the Scope Module should only be undocked from the Diagnostic Tool when it is off. To prevent accidental loss of data, make it a practice to first save the current data if desired, then select either the **Power Off** or **Back** icon from the Scope Multimeter toolbar to stop meter operation. Power Off saves the current settings, but does not save data. Settings are not saved if Back is selected.



NOTE:

If the Scope Module:

- Is undocked from the Diagnostic Tool when it is on, or
- Is exposed to a electro static discharge (ESD) while it is being used remotely

the following will occur:

- Communication between the Diagnostic Tool and the Scope Module will be terminated.
- All current data and settings will be lost.
- An error message (e.g. **Meter/Scope Not Found**) will display to indicate that Scope Module communication has terminated.

When communication is reestablished (after a communication loss), the Scope Multimeter application is restarted and the Scope Multimeter main menu page is displayed.



NOTE:

When the M4 is connected into it's docking station on the rear of the diagnostic tool or is connected to the diagnostic tool with a USB cable remotely, the M4 USB connection status indicator (lower right of screen) is displayed. When the M4 is removed from the docking station, and is not connected by a USB cable the status indicator background displays red with an "X".

M4 Scope/Meter Connection Status Indicator			
Icon	Background Color	Condition	Action/Indication
	Red	Not Connected/Not Paired	Connect the M4 to the docking station on the rear of the diagnostic tool or (if using remotely) connect the M4 to the diagnostic tool with a USB cable.
	Grey	Connected/Paired	Indicates the M4 is connected to the docking station on the rear of the diagnostic tool or (if using remotely) is connected with a USB cable.



To setup the Scope Module for remote operation:

1. Depress the Scope Module release tab located on the top of the Diagnostic Tool ([Figure 8-1](#)).

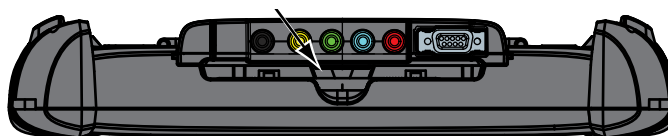

Figure 8-1 Scope Module release tab

2. Slide the Scope Module off of the Diagnostic Tool.
3. Locate the USB jack on the bottom of the Scope Module ([Figure 8-2](#)).

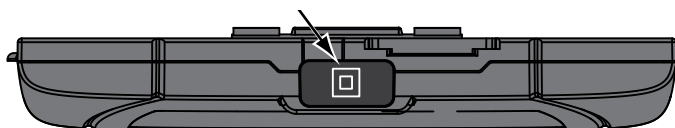

Figure 8-2 Scope Module USB jack location

4. Connect the square end of the USB cable to the jack on the Scope Module.
5. Connect the rectangular end of the USB cable to either of the two ports on the Diagnostic Tool.
The Scope Module is now ready for remote use.

8.2 Getting Started

The Scope and Multimeter module enables the following functions:

- Lab Scope
- Ignition Scope
- Graphing Multimeter
- Digital Multimeter

8.2.1 Capabilities

The following tables detail the software and hardware capabilities.

Table 8-1 Scope

Function	Range	Accuracy/Comments
Signal Measurement	Ch. 1—yellow banana jack Ch. 2—green banana jack Ch. 3—blue banana jack Ch. 4—red banana jack	Each channel input is referenced to common ground input (GND—black banana jack)
Sample Rate	For 50uS sweep 6MSPS For 100uS sweep 3MSPS For all other sweeps 1.5 MSPS	Continuous sampling, MSPS = mega samples per second
Bandwidth	DC–3 MHz	3 db point @ 3 MHz
Input Impedance	10 MOhm @ DC 4 kOhm @ 3 MHz	Channel 1–4
VDC (Full Scale)	100mV–400V	Do not measure greater than 75VDC
VAC (Full Scale)	100mV–400V	Do not measure greater than 50VAC (rms)
Low Amp Probe	20A scale (100mV/Amp) 40A scale (10mV/Amp) 60A scale (10mV/Amp)	Connect Low amp Probe (+) to Ch. 1 (yellow banana jack) and (–) to GND input (black banana jack). See NOTE below.

Table 8-2 Graphing Multimeter (part 1 of 2)

Function	Range	Accuracy/Comments
Signal Measurement	Ch. 1—yellow banana jack Ch. 2—green banana jack Ch. 3—blue banana jack Ch. 4—red banana jack	Each channel input is referenced to common ground input (GND—black banana jack)
Sample Rate	1.5 MSPS	Continuous sampling, MSPS = mega samples per second
Bandwidth	DC–3 MHz	3 db point @ 3 MHz
Input Impedance	10 MOhm @ DC 4 kOhm @ 3 MHz	Channel 1–4
VDC (Full Scale)	75VDC	Do not measure greater than 75VDC
VAC (Full Scale)	50VAC	Do not measure greater than 50VAC (rms)

Table 8-2 Graphing Multimeter (part 2 of 2)

Function	Range	Accuracy/Comments
Ohm Measurement Diode Test Continuity Test	Ch. 3—blue banana jack Ch. 4—red banana jack	-
Ohms	40 Ohm–4 MOhm	Fixed scales
Low Amp Probe	20A scale (100mV/Amp) 40A scale (10mV/Amp) 60A scale (10mV/Amp)	Connect Low amp Probe (+) to Ch. 1 (yellow banana jack) and (–) to GND input (black banana jack). See NOTE below.

Table 8-3 Digital Multimeter

Function	Range	Accuracy/Comments
Signal Measurement	Ch. 1—yellow banana jack	Channel 1 input is referenced to common ground (GND—black banana jack)
VDC (Full Scale)	75VDC	Do not measure greater than 75VDC
VAC (Full Scale)	50VAC	Do not measure greater than 50VAC (rms)
Signal Measurement Input Impedance	10 MOhm	-
Ohm Measurement Diode Test Continuity Test	Ch. 3—blue banana jack Ch. 4—red banana jack	-
Ohms	40 Ohm–4 MOhm	Fixed scales or Auto Ranging
Glitch capture	Approximately 50 uS	-
Diode Test	2 V Scale	-

**NOTE:**

200V to 400V scales are not to be used to measure signals greater than 50VAC (rms) or 75VDC.

IMPORTANT:

Do not use the Low Amp Probe to measure current on conductors at a potential greater than 46VAC peak or 70VDC.

8.2.2 Leads, Probes and Adapters

The Scope Module uses standard safety banana plugs that are compatible with many accessories. The various leads, probes, clips, and adapters that are supplied with, or available as optional equipment, are explained in this section.

IMPORTANT:

When removing leads from their sockets, do not pull on the wire because it can damage the leads. Pull on the plug.

Channel 1 Lead

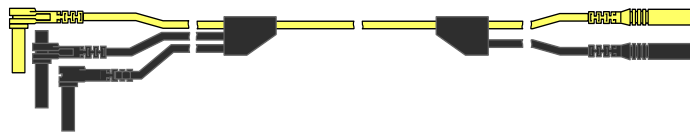

Figure 8-3 Yellow Channel 1 Lead

The shielded yellow lead is used for Channel 1 (Figure 8-3) and other channel connections that need additional grounding. The lead color matches the color of socket 1 on the Scope Module and the color of trace 1 on the test screens.

This yellow lead includes a black, right-angle, common ground plug and a black, stackable, common ground plug. The non-stackable ground plug always connects to the ground (GND) jack on top of the Diagnostic Tool. The stackable ground plug is used for connecting additional leads, such as the Channel 2 Lead or the Secondary Coil Adapter Lead, that require grounding. The stackable lead grounds through the non-stackable lead and does not need to be connected to the jack on the Diagnostic Tool.

Channel 2 Lead

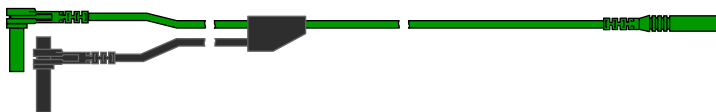

Figure 8-4 Green Channel 2 lead

The shielded green lead (Figure 8-4) is used for Channel 2. The lead color matches the color of socket 2 on the Scope Module and the color of trace 2 on the test screens. This green lead includes a stackable, black, right-angle ground plug.

Channel 3 Lead

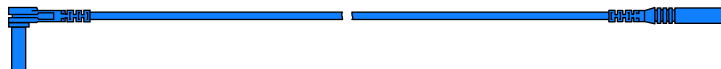

Figure 8-5 Blue Channel 3 lead

The non-shielded blue lead (Figure 8-5) is used for either Channel 3 or Digital Meter minus (-). The lead color matches the color of socket 3 on the Scope Module, as well as the color of trace 3 on the test screen.

Channel 4 Lead

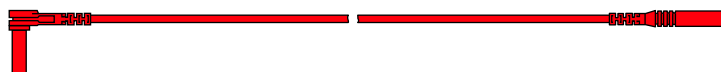

Figure 8-6 Red Channel 4 lead

The non-shielded red lead (Figure 8-6) is used for either Channel 4 or Digital Meter plus (+). The lead color matches the color of socket 4 on the Scope Module, as well as the color of trace 4 on the test screen.

Alligator Clips

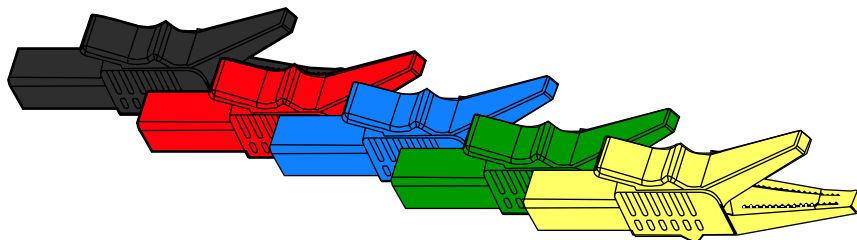

Figure 8-7 Alligator clip

Insulated alligator clips, colored to match each test lead, are included. A black clip for the common ground lead is also supplied (Figure 8-7). Each clip plugs into the straight end of a channel lead.

Test Probes

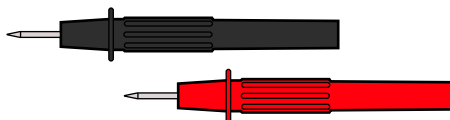

Figure 8-8 Test probe

Two test probes are included, one black and one red (Figure 8-8). The test probes plug into the straight end of the test leads.

Secondary Coil Adapter Lead (optional)

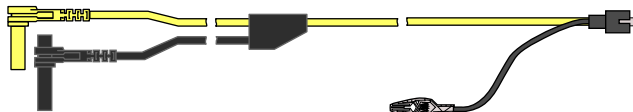

Figure 8-9 Secondary Coil Adapter lead

The optional Secondary Coil Adapter lead (Figure 8-9) connects to the clip-on secondary wire adapter, coil-in-cap adapter or coil-on-plug adapter to display secondary waveforms.

Secondary Ignition Clip-on Wire Adapter (optional)

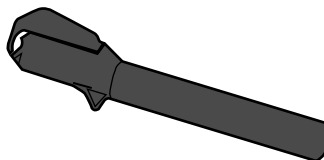

Figure 8-10 Secondary Ignition Clip-on Wire Adapter

The optional Secondary Ignition Clip-on Wire Adapter (Figure 8-10) connects the Secondary Coil Adapter lead to a secondary ignition lead on the vehicle to display ignition patterns.

Inductive RPM Pickup Adapter (optional)



Figure 8-11 Inductive RPM Pickup adapter

The optional Inductive RPM Pickup adapter (Figure 8-11) connects to the scope auxiliary connector of the Diagnostic Tool with a DB9F plug. It can be used to trigger a waveform or display RPM. With the Ignition Scope, the RPM Pickup connects to cylinder number one to establish the firing order.

Low Amp Current Probe (optional)

The optional Low Amp Current Probe provides accurate and reliable non-intrusive testing of ignition coils, fuel injectors, fuel pumps, relays, electric motors, and parasitic draw. The optional Low Amp Current Probe measures current from 10 mA to 60 Amps.



Figure 8-12 Low Amp Current Probe

8.2.3 Menu Options, Scope Multimeter

The Menu icon on the Toolbar at the base of the screen opens a menu with the following options:

- [Safety Information](#)—opens the *Important Safety Instructions* document.
- [File](#)—allows you to print or save the data or meter setup being viewed.
- [Setup](#)—allows you to adjust certain tool settings once a test has been selected.
- [Help](#)—allows you to view supporting documentation.

File

Use to print or save a copy of the data currently being viewed. Selecting opens a submenu:

- **Save Multimeter**—opens an additional submenu with these options:
 - **Save Configuration**—saves the current screen setup as a preset for quick access.
 - **Save Single Frame**—saves a recording of the current screen.
 - **Save All Frames**—saves a recording of the current screen plus all the data in the buffer.
- **Print**—opens a standard Windows Print dialog box for printing the current screen.

See [Printing / Printer Setup](#) on page 27.

Setup

This option allows you to adjust tool settings to your personal preferences. Selecting opens a menu of the following:

- [Unit Setup](#)—opens the Unit Setup dialog box to adjust trace and display settings
- [Snapshot](#)—opens the Snapshot dialog box for selecting how triggered data is saved.
- [Ignition](#)—opens the Ignition dialog box for setting up to display secondary ignition patterns.

Help

A variety of utilities and additional resources are available through the Help menu:

- User Manual
- Version Info
- Activation Status
- Scope About

Scope About

This option opens a dialog box that contains the software version and other specific details about the Scope module.

8.3 Navigation

The following section describes how to navigate the screen interface.

8.3.1 Screen Layout

The screens typically include the following sections (Figure 8-13):

- **Scope Multimeter Toolbar**—allows you to configure the tool for the type of test and to adjust the settings for each channel, or trace.
- **Main Body of the screen**—displays test results. Options on the toolbar let you select how tests display on the screen.
- **Trace Details**—displays trace settings, which can be adjusted or switched through the touch screen.
- **Record/Playback Control Toolbar**—allows you to record and navigate through paused data.









- 1— Scope Multimeter Toolbar
- 2— Main body
- 3— Trace Details
- 4— Record/Playback Control Toolbar

Figure 8-13 Scope Multimeter screen layout

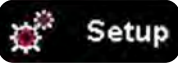
Scope Multimeter Toolbar

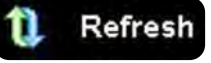
The Scope Multimeter toolbar is used to set up the tool for testing and to configure the settings for each trace. [Table 8-4](#) on page 106 gives brief descriptions of the control icons on the toolbar:

Table 8-4 Scope Multimeter toolbar icons

Name	Icon	Description
Back		Returns to the previously viewed screen.
Setup		Opens a dialog box that allows you to select personal preferences for viewing and saving data.
Data		Switches the trace information displayed at the base of the screen between three available states.
Cursors		Opens a dialog box that allows you to switch cursors on and off, and to reposition them on the screen.
Refresh		Clears the Min/Max and Current values on the trace details section of the screen.
File		Opens a dialog box that allows you to select options for saving data.
Print		Opens a dialog box that allows you to configure and print data. See Printing / Printer Setup on page 27.
Power Off		Switches the Scope Multimeter off. This retains the settings and reduces battery drain when switching to a different module. The Play and Record icons on the Playback toolbar switch the meter back on.

Main Body of the Screen

The main body of the screen varies depending on what display options have been selected. Up to four traces, along with digital readouts of current signal values, signal status and triggering conditions, can be displayed simultaneously on the main body of the screen. Adjustments to the display are made through the scope toolbar as explained above.

Each trace is displayed as voltage over time on a standard oscilloscope screen. Voltage level is recorded on the vertical, or “y”, axis and time is presented on the horizontal, or “x”, axis of the screen. Values are shown for each graduation on the scales.

When using transducers, the pressure being sensed by the transducer is converted into a voltage signal. However, the values are shown as pressure on the display screen rather than voltage.

Trace Details

The Trace Details section displayed at the base of the screen can be used to quickly adjust settings for capturing the trace. The Trace details are accessed using either the **Data** icon on the upper toolbar or the **Touch and Grow** icon on the Playback toolbar. Both icons function the same and cycle the Trace Details selection through three states:

- **Displayed**—trace settings are displayed in this mode.
- **Expanded**—trace settings are displayed in a larger format in this mode.
- **Off**—trace settings are not displayed in this mode.

Adjustments are made by selecting the item to be changed on the touch screen. A dash (–) indicates a function that is not selected, and an icon indicates an active function (Figure 8-14).



- 1— Peak Detect on
- 2— Filter on
- 3— Inverted trace
- 4— Coupling AC on
- 5— Sweep setting
- 6— Trigger setup
- 7— Trigger set on the rising slope

Figure 8-14 Sample data detail display

The following trace adjustments and settings are available:

- **Profile**—switches the trace for the selected channel on and off.
- **Channel**—opens a dialog box that allows you to configure the trace setup (see [Trace Controls](#) on page 112 for details).
- **Probe**—opens a dialog box that allows you to select the type of test probe being used.
- **Peak Detect**—maximizes the signal sampling rate in order to capture fast events, such as spikes, glitches and other anomalies, that may normally be undetected.
- **Filter**—smooths out the trace when the signal is disrupted by noise or other interference.
- **Inverted**—switches the polarity of the displayed signal.
- **Coupling AC**—subtracts the average value of the waveform by blocking the DC portion of an input signal to amplify the AC portion. This makes small variations in the trace visible.
- **Scale**—opens a dialog box that allows you to select the scale, which is the total value displayed on the vertical axis of the display.
- **Sweep**—the current sweep setting is shown in white at the end of the scale list, selecting opens a dialog box that adjusts the sweep (see [Sweep Controls](#) on page 114 for details).
- **Slope**—only active when a trigger is set, indicates whether the trigger is set to activate on the rising or falling slope of the trace. Selecting the slope icon switches the slope. The white dash at the bottom of the slope column is used to set the trigger, selecting it opens the trigger setup dialog box (see [Trigger Controls](#) on page 115 for details).

Record/Playback Control Toolbar

The record/playback control toolbar at the base of the screen is used for recording data and for reviewing paused data. Use the stylus or your finger tip to activate the icons. A position counter in the toolbar displays a numerical value of where the current screen is in relation to the entire recorded file.

Use the slider in the middle of the toolbar to quickly move through paused data.











Figure 8-15 Sample data buffer slider

Use the toolbar icons ([Table 8-5](#)) to more precisely navigate the data.

Table 8-5 Data buffer toolbar icons (part 1 of 2)

Name	Icon	Description
Snapshot		Arms the software to take a snapshot of the sampled data
Step Back		Moves to the previous point in the recorded data
Back 1 Frame		Moves to the previous frame in the recorded buffer

Table 8-5 Data buffer toolbar icons (part 2 of 2)

Name	Icon	Description
Stop		Stops recording data
Record		Begins recording data
Play Recording		Plays the data recording in a continuous loop at actual speed
Forward 1 Frame		Moves to the next frame in the recorded data
Step Forward		Moves to the next point in the recorded data
Position Indicator		In record mode, indicates how much data is collected. In playback mode; shows the position of the buffered data currently displayed as minutes:seconds:milliseconds of elapsed time
Touch and Grow		Expands and collapses the Trace Detail area on the display screen to allow for easier finger tip control
Zoom		Increases or decreases the magnification of the graph

8.3.2 Making Selections

Most selections for setting up and operating the scope are made using the stylus and the scope toolbar. The cursor lines, the trace zero line, and the trigger point indicator (+) can be repositioned by selecting and dragging them in the main body of the screen.

There are two basic types of controls on the toolbar:

- Switches
- Dialog boxes

A Switch changes states when selected. Changes happen immediately as the selection is made.

A dialog box opens as a separate window on the screen and typically includes a number of choices. Changes happen immediately, however, the dialog box must be closed to return to the main window and continue. Make a selection to close the dialog box.

8.4 Operations

This section describes configuring the scope or meter and performing tests.

8.4.1 Starting the Scope and Multimeter

Use the following procedure to set up the scope multimeter for performing tests.



To start the scope multimeter:

1. Select the **Scope Multimeter** icon on the Home screen.
The Scope Multimeter main menu, a list of setup options, displays;
 - Lab Scope
 - Ignition Scope
 - Graphing Meter
 - Digital Multimeter
 - Presets
2. Select from the menu options.
A submenu of scope or meter configuration displays, see below for additional information.
3. Select a configuration and the Scope Multimeter opens.

Presets

Presets are factory configured meter settings for common component tests. Selecting opens a list of available setups. Selecting from the list opens the scope multimeter configured to perform the selected test. In addition to the factory presets, you can create your own custom meter configurations and save them as presets.

Lab Scope Options

The following options are available for testing:

- 4 Channel Lab Scope
- Volts DC
- Low Amps (20)
- Low Amps (40)
- Low Amps (60)
- Ignition Probe
- 100 PSI Vacuum
- 100 PSI Pressure
- 500 PSI Pressure
- 5000 PSI Pressure

Ignition Scope Options

The following options are available for testing:

- Parade
- Cylinder
- Raster
- Superimposed
- Single Cylinder Ignition

Graphing Options

The following options are available for testing:

- 4 Channel Graphing
- Volts DC
- Volts DC Average
- Volts AC RMS
- Ohms
- Frequency
- Pulse Width
- Injector Pulse Width
- Duty Cycle
- Low Amps (20)
- Low Amps (40)
- Low Amps (60)
- MC Dwell (60)
- MC Dwell (90)
- 100 PSI Vacuum
- 100 PSI Pressure
- 500 PSI Pressure
- 5000 PSI Pressure

Digital Multimeter Options

The following options are available for testing:

- Volts DC
- Volts DC Average
- Volts AC RMS
- Ohms
- Diode/Continuity
- Low Amps (20)
- Low Amps (40)
- Low Amps (60)

8.4.2 Measurement Out of Range

A group of arrows display when a measurement is out of range for the scale selected:

- Arrows pointing UP—measurement over maximum range
- Arrows pointing DOWN—measurement under minimum range

Voltage measurements also display arrows in place of live values when the voltage exceeds the input rating of the meter.

WARNING



Risk of electrical shock.

- **Do not exceed voltage limits between inputs as indicated on the rating label.**
- **Use extreme caution when working with circuits that have greater than 40 volts AC or 24 volts DC.**

Electrical shock can cause personal injury, equipment damage, or circuit damage.

IMPORTANT:

If arrows are displayed in the live voltage values, discontinue circuit testing.

Correct an out-of-range condition by selecting a scale setting appropriate for the signal being sampled. See [“Trace Controls” on page 112](#) for more information.

8.4.3 Scope and Multimeter Setup

The following sections explain how to adjust the scope and multimeter for the specific type of signal being sampled. Most of these setup operations are available from the toolbar.

Trace Controls

The Trace controls are used to adjust individual characteristics of how the signal is sampled and displayed for each of the four traces.



To adjust trace controls:

1. Select **Setup** from the Scope Multimeter toolbar.
The Scope Multimeter Preferences dialog box opens.
2. Select **Traces** to open the submenu.
3. Select the trace to be configured from the submenu.
The traces dialog box displays ([Figure 8-16](#)).

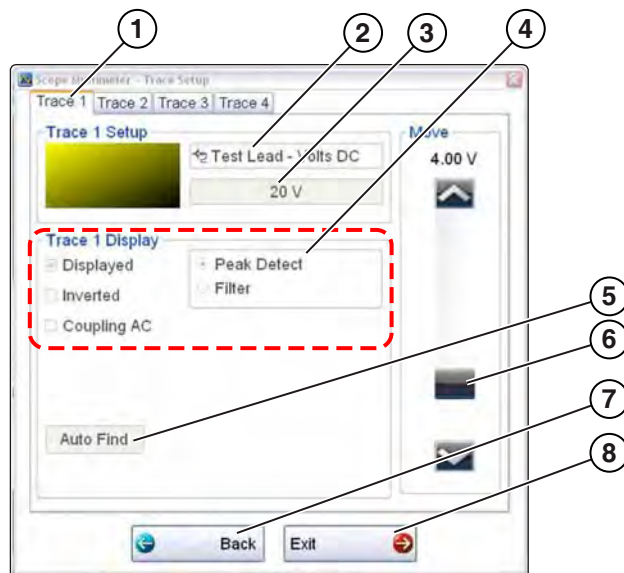

- 1— Trace tabs
- 2— Trace Probe icon
- 3— Trace Scale icon
- 4— Trace characteristics check boxes
- 5— Auto Find icon
- 6— Baseline position
- 7— Back icon
- 8— Exit icon

Figure 8-16 Traces dialog box

4. Select the **Trace Probe** icon to open the menu.
5. Highlight a probe on the list and select **OK** to close the window.
6. Select the **Trace Scale** icon to adjust the vertical scale of the display. A dropdown menu opens. Menu options vary depending upon which test lead is selected.
7. Select a trace scale option, then close the window.
8. Select or deselect the trace characteristic items as needed:
 - **Displayed**—this trace is on screen when checked, and not visible when not checked.
 - **Inverted**—signal polarity is reversed when checked, normal when not checked.
 - **Coupling AC**—check when sampling an AC signal, uncheck for DC signals.
 - **Peak Detect**—use when trying to capture a fast event or signal glitch.
 - **Filter**—use when radio frequency interference (RFI) may be disrupting the signal.
9. The scope samples the signal and internally calculates the best way to display it when **Auto Find** is selected. A scale and the vertical position for the zero line of the trace that allows the whole waveform to fit on the screen is established when Auto Find is selected. If Auto Find is selected on the trigger channel, it also sets the trigger level halfway between the minimum and maximum value of the sampled signal to provide a stable waveform.
10. The baseline position is the zero line of the trace, use the slider and arrows to adjust it.
11. Select **Back** to return to the Preferences dialog box, or select **Exit** to close the dialog box and return to the scope.

Sweep Controls

Sweep is the amount of time represented by the screen, or the horizontal scale of the display.



To adjust Sweep controls:

1. Select **Setup** from the Scope Multimeter toolbar.
The Scope Multimeter Preferences dialog box opens.
2. Select the **Sweep** icon to open the sweep dialog box (Figure 8-17)

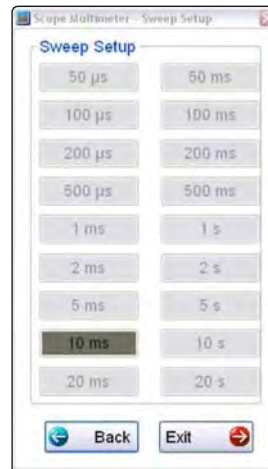

Figure 8-17 Sample Sweep Setup dialog box

3. Choose an option from the list.
4. Select **Back** to return to the Preferences dialog box, or select **Exit** to close the dialog box and return to the scope.

Trigger Controls

Triggering allows you to set the scope so that it only begins displaying a trace once predetermined signal conditions, or triggers, are met. The trigger point is indicated by a plus sign (+) on the scope grid. The plus sign can be dragged across the grid with the stylus to roughly position it. The trigger controls allow you to precisely position the trigger.



To adjust trigger controls:

1. Select **Setup** from the Scope toolbar. The Scope Multimeter Preferences dialog box opens.
2. Select **Trigger** to open the Trigger Setup dialog box (Figure 8-18).
3. Use the dialog box controls to set the trigger.
4. Select **OK** to close the dialog box.
5. Select **Back** twice to close the Scope Multimeter Preferences dialog box.

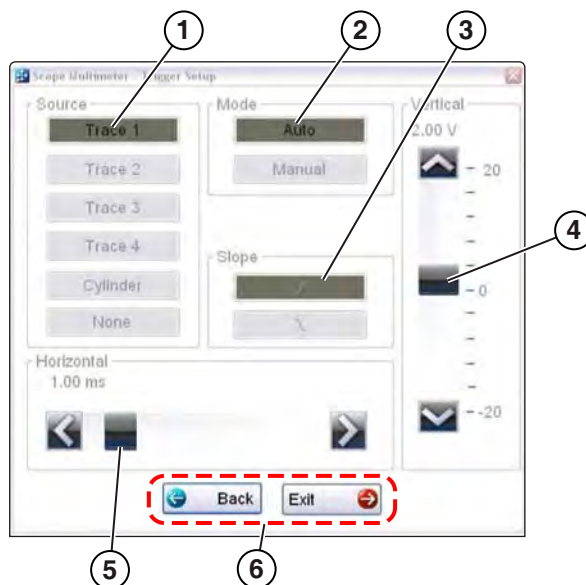

1— Source—selects the triggering event:

- Trace 1—sets the trigger to channel 1.
- Trace 2—sets the trigger to channel 2.
- Trace 3—sets the trigger to channel 3.
- Trace 4—sets the trigger to channel 4.
- Cylinder—sets triggering to the firing of a cylinder detected by the optional RPM Pickup or Secondary Ignition Adapter.
- None—switches triggering off.

2— Mode—sets the method of triggering:

- Auto (automatic)—if a trigger is found, the waveform displays. If a trigger is not found after about a half second, the waveform and a “trigger not found” message displays.
- Manual—if a trigger is found, the waveform displays. If a trigger is not found nothing displays (no waveform and no message).

3— Slope—sets triggering to the rising (top icon) or falling (lower icon) slope of the signal waveform.

4— Vertical position—moves the trigger position up and down on the grid.

5— Horizontal position—moves the trigger timing left and right on the grid

- 6— Select **Back** to return to the Preferences dialog box, or select **Exit** to close the dialog box and return to the scope.

Figure 8-18 Trigger controls

View Controls

Use the view controls to set display attributes.



To adjust view controls:

1. Select **Setup** from the Scope Multimeter toolbar.
The Scope Multimeter Preferences dialog box opens.
2. Select **View** to open a submenu.
3. Select an option from the submenu dialog box. Option details are explained below.
Four options are available on the submenu:
 - **Display**—use to adjust what information displays and how it appears
 - **Layout**—use to set how many traces display and how they display on the screen
 - **Units**—use to adjust time and voltage interval settings
 - **Back**— use to return to the Preferences dialog box, or select **Exit** to close the dialog box and return to the scope.

Display Settings

Selecting **Display** from the View submenu opens the Display dialog box (Figure 8-19).



Figure 8-19 Sample Display dialog box

The following options are available from the Display dialog box:

- **Show RPM**—adds an engine speed field at the top of the screen (Figure 8-20).

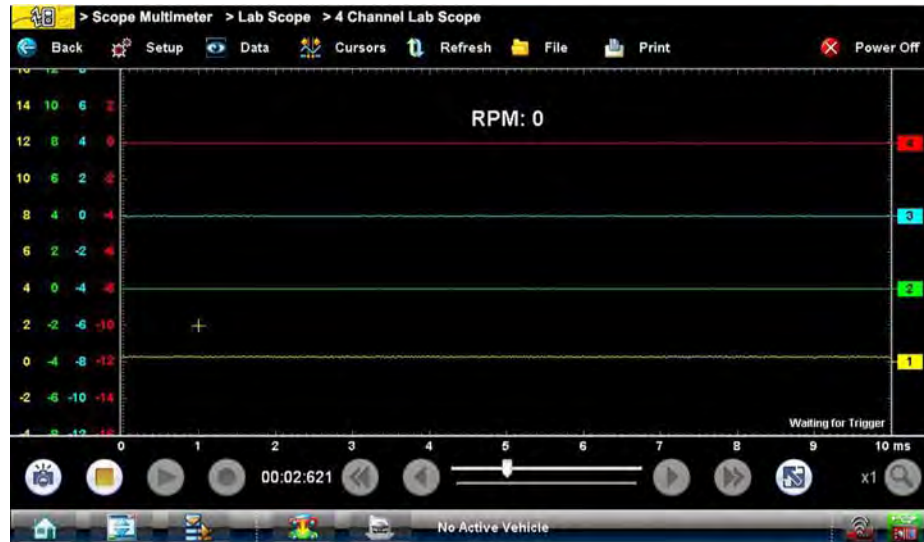

Figure 8-20 Sample Show RPM selected

- **Show Digital KV**—available only in ignition scope, displays digital kilovolt readings, rather than waveforms, on the screen (Figure 8-21).



Figure 8-21 Sample Show Digital KV selected

- **Show Grid**—switches grid lines on the screen off and on (Figure 8-22).



Figure 8-22 Sample grid selected

- **Invert Colors**—switches the screen background to white.

Layout Settings

The selected radio knob on the Layout dialog box shows which setting is active. Use your finger or the stylus to switch between settings:

- **1 window**—shows all traces on the same screen (Figure 8-22).
- **2 windows**—shows two separate traces in two ways: horizontal, one below another (Figure 8-23) or vertical, side-by-side (Figure 8-24).
- **3 windows**—shows three traces, one below another, on the same screen (Figure 8-25).
- **4 windows**—shows four traces, one below another, on the same screen.



Figure 8-23 Sample 2 Windows horizontal display

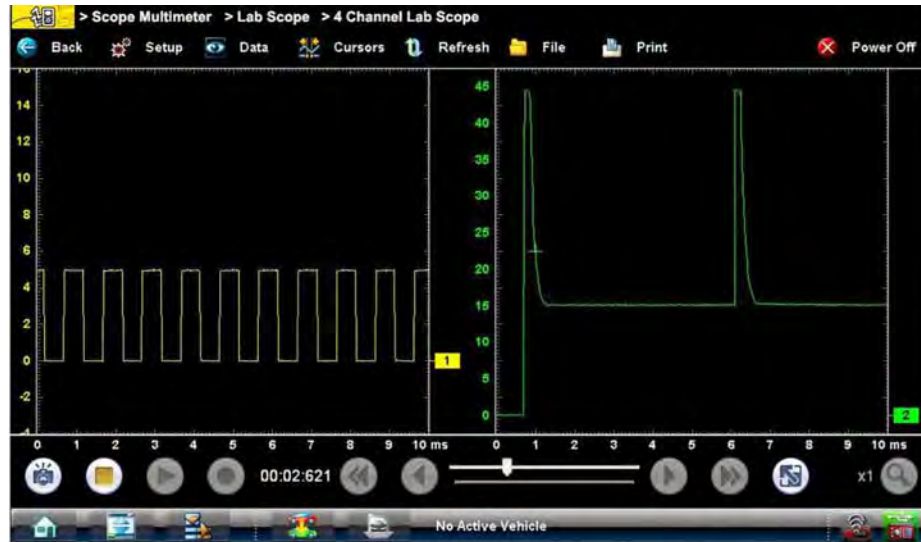

Figure 8-24 Sample 2 Windows vertical display

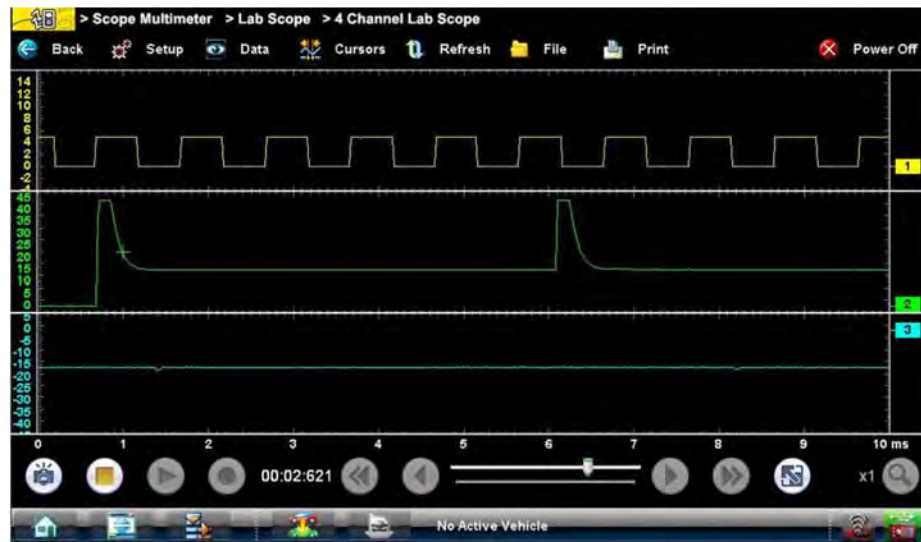

Figure 8-25 Sample 3 Windows display

Unit Setup

The Unit Setup dialog box allows you to switch between Full Scale or Per Division settings for the trace setup and the display settings. Selecting Full Scale configures the units to the full viewing area of the screen, while Per Division adjusts the units to a single division (one tenth) of the screen.

The selected radio knob on the Units dialog box shows which setting is active. Use your finger or the stylus to switch between settings (Figure 8-26).

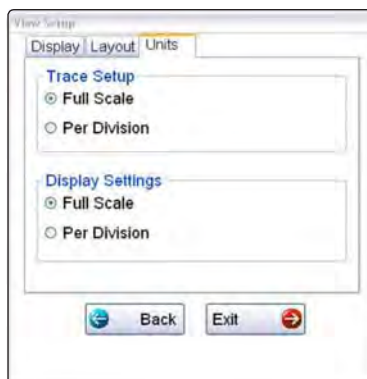

Figure 8-26 Sample View Units dialog box

Setup Controls

Basic tool settings are adjusted here.



To adjust setup controls:

1. Select **Setup** from the Scope Multimeter toolbar.
The Scope Multimeter Preferences dialog box opens.
2. Select **Setup** from the dialog box.
A submenu of options displays:
 - **Back**—use to return to the Preferences dialog box.
 - **Units**—use to set how measurement values display, US standard or metric.
 - **Snapshot**—use to adjust the percentage of data captured following a trigger event.
 - **Ignition**—use to configure the ignition scope for the test vehicle.Selecting from the submenu opens a dialog box for that item. Dialog box options for each item are discussed in the following sections.
3. Make dialog box selections as needed.
4. Select **Exit** to close the dialog box and return to the scope.

Units

Selecting Units opens the Setup dialog box. The units of measurement can be changed between US customary or metric. The selected radio knobs on the Setup dialog box show which settings are active (Figure 8-27).



Figure 8-27 Sample Setup Units dialog box

Abbreviation	Description
bar	bar
inHg	inches of mercury
kg/cm2	kilograms per centimeter squared
kPa	kilopascal
mmHg	millimeters of mercury
psi	pounds per square inch

Snapshot

The Snapshot tab of the Setup dialog box opens a window that allows you to select how much data is captured after a snapshot is triggered (Figure 8-28). Available selections, which range from ten to ninety percent in ten-percent increments, are shown as icons with the current setting highlighted. Select a icon, then select **Back** or **Exit** to close the dialog box.

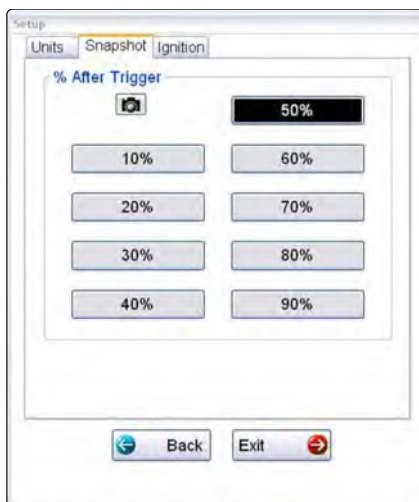

Figure 8-28 Sample Snapshot dialog box

Refer to [Trigger Controls](#) on page 115 for information on how to setup a trigger.

Ignition

The Ignition tab of the Setup dialog box is used to configure the scope for displaying secondary ignition patterns. There are two main selection fields (Type and Cylinders) and the fields vary depending upon the type of ignition system selected in dialog box (Figure 8-29).



Figure 8-29 Sample Setup Ignition dialog box



To setup Ignition tests

1. Select the **Setup** icon to open the Setup dialog box.
2. Select the **Ignition** tab of the dialog box.
3. Highlight the ignition system for the test vehicle in the “Type” field:
 - **Standard**—use for systems with a distributor
 - **Waste Spark**—use for coil pack systems that fire 2 plugs simultaneously
 - **Direct**—use for coil-on-plug systems
 - **Other**—use for systems that do not fit any of the above categories
4. Select the number of cylinders for the test vehicle in the “Cylinders” field.
Scroll through the list using the up and down arrows on either side of the number.
5. This step varies depending upon the type of ignition system:
 - If testing a Standard system, select the Firing Order.
 - If testing an Other system, select the RPM Factor.
Scroll through the list of available choices using the up and down arrows below the displayed firing order or RPM factor.
6. This step also varies depending upon the type of ignition system:
 - On a Standard or Direct system, choose between Coil and Plug for the Number 1 Trigger.
 - On a waste Spark system, select the polarity of the firings using the +, –, and arrow icons.
7. Select **Back** to return to the Preferences dialog box, or select **Exit** to close the dialog box and return to the scope.

Data

The **Data** icon on the toolbar switches the trace details information at the base of the screen through three states as previously explained in [Trace Details](#) on page 107.

Cursor Controls

Select **Cursors** from the toolbar to open the Cursors dialog box ([Figure 8-30](#)).

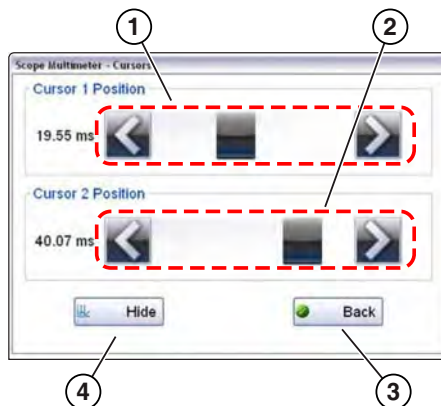

- 1— Cursor 1 controls
- 2— Cursor 2 controls
- 3— Show or Hide icon
- 4— Back icon

Figure 8-30 *Cursor controls*

Cursor 1, the top slider and arrows, is the left-hand cursor on the screen. Cursor 2, the lower set of controls, is the right-hand cursor on the screen. Drag the slider or select the arrows to position the cursors. Each tap of the stylus moves the cursor incrementally in the direction of the arrow.

Select **Show** to display the cursors (the icon changes to Hide).

Select **Hide** to conceal the cursors (the icon changes to Show).

Select **Back** to close the dialog box.

Refresh Controls

Selecting the **Refresh** icon from the Scope Multimeter Toolbar clears the minimum and maximum digital values and updates the viewing screen.

File Controls

Selecting **File** from the toolbar opens a dialog box with a menu of save options:

- **Save Configuration**—saves the current setup values as a preset.
- **Save Single Frame**—saves the data currently on the screen only.
- **Save All Frames**—saves the current screen plus all the data stored in the buffer.



To save a file or configuration:

1. Select **File** from the toolbar.
2. Select a save option from the dialog box.

Figure 8-31 *Sample file setup dialog box*

The Save As dialog box and the virtual keyboard open.

3. Use the keyboard to name the file to be saved, then either select the **Save** icon or select **return** on the keyboard.

A configuration description dialog box opens.



NOTE:

The description entered here is what displays in the information panel of the Data Manager.

4. Use the keyboard to enter a description of the file to be saved.
5. Select the **OK** icon or select **return** on the keyboard.
6. Select **OK** to close the file setup dialog box.

Once a configuration is saved, it becomes available as a preset. Files are saved to the Scope Multimeter Data Folder and can be retrieved through the **Data Manager**.

Print Controls

Selecting Print from the toolbar opens a standard Windows Print dialog box set up to print the current screen. A printer must be connected and setup on the Diagnostic Tool. If not, the "Add Printer Wizard" opens and guides you through the procedure. Select from the menus as needed.

Vehicle History allows you to manage and retrieve vehicle records, for vehicles that have been scanned or identified previously. You can also activate a vehicle, so there is no need to go through the complete vehicle identification sequence when performing a retest after repairs have been made.

9.1 Screen Layout

There are two main parts to the vehicle records list screen:



- 1— Vehicle History Toolbar
2— Main Body (Records List)

Figure 9-1 Vehicle records list screen

9.1.1 Vehicle History Main Body (Records List)

The main body of the screen lists all of the available vehicle records. By default, records are shown in the order in which they are entered. However, you can resort them by any of the categories shown as column headings. You can also resize the individual columns.



To sort records:

1. Select a category heading.
The listed items resort according to the selected category. A triangle appears alongside the name of the column that was used for the sort.
2. Select the triangle in the heading to reverse the sort order.



To resize a column:

1. Select the line separating two columns.
A line with arrowheads appears to show the column is ready for resizing.
2. Drag the line left or right to increase or decrease the column width.

9.1.2 Vehicle History Toolbar

The table below gives brief descriptions of the control icons on the toolbar:

Table 9-1 *Toolbar icons*

Name	Icon	Description
Back		Returns to the previously viewed screen.
Activate		Activates the selected vehicle, for use with other functions (e.g. Scanner, Guided Component Tests, etc).
View		Opens the selected vehicle record.
Delete		Deletes the selected vehicle record from memory.
Manage		Opens the vehicle Manage Records screen.
Search		Opens a window that allows you to locate a particular vehicle record.
Show All		Available only after a search, use to return to a complete vehicle records list.
Settings		Opens a window that allows you to configure which fields display on main records list screen.

Activate

Use this icon to activate a vehicle for use in other functions (e.g. Scanner, Guided Component Tests, etc.). The diagnostic tool will use the identification information stored in the vehicle history record to load the correct vehicle database, so there is no need to identify the test vehicle again.



To activate a vehicle:

1. Locate and highlight the desired vehicle record on the records list screen.
2. Select **Activate** from the toolbar.
The Activate icon is removed from the toolbar once a vehicle has been selected.
3. Select the **Home** icon.
The Home screen displays with the activated vehicle shown on the toolbar.
4. Select any Function icon on the Home screen to begin testing.

View

Select **View** to open, edit, add notes, and print a vehicle record.



To open and/or modify a vehicle record:

1. Highlight the desired vehicle record from the vehicle records list screen, then double click it, or select **View** from the toolbar.

The record for the selected vehicle opens ([Figure 9-2](#)).

The vehicle record includes vehicle ID information, DTC data, and other data entry fields for owner and vehicle information, and technician notes. Depending on the vehicle information that was used to identify the vehicle, some data may be already entered. The example below shows, DTC scan results from the last code scan performed, and an attachment “Vehicle System Report Data” PDF file.

Vehicle ID information is captured slightly different across the different functions (e.g. Scanner, Guided Component Tests, etc.), as some functions may capture more/less information during the process. Selecting the **Other Vehicle ID** button, opens a listing of the captured vehicle ID fields from each applicable function. If more than one function was used to ID the vehicle, you are given the option to use that vehicle ID set as the default ID for the vehicle record.

Figure 9-2 Sample vehicle record



NOTE:

The virtual keyboard automatically opens the first time you select within one of the data fields.

2. Use the virtual keyboard to enter information in the data fields. The data is automatically saved.
3. Select **Back** to return to the vehicle records list screen.

Delete

Select **Delete** to remove unwanted items from the vehicle records list. Highlight the record to remove, then select **Delete**.

Manage

Select **Manage** to quickly remove individual records, or all the vehicle records from the vehicle records list. Highlight the record to remove, then select **Delete**, or use the Select All or Deselect All options to remove all records (Figure 9-3).

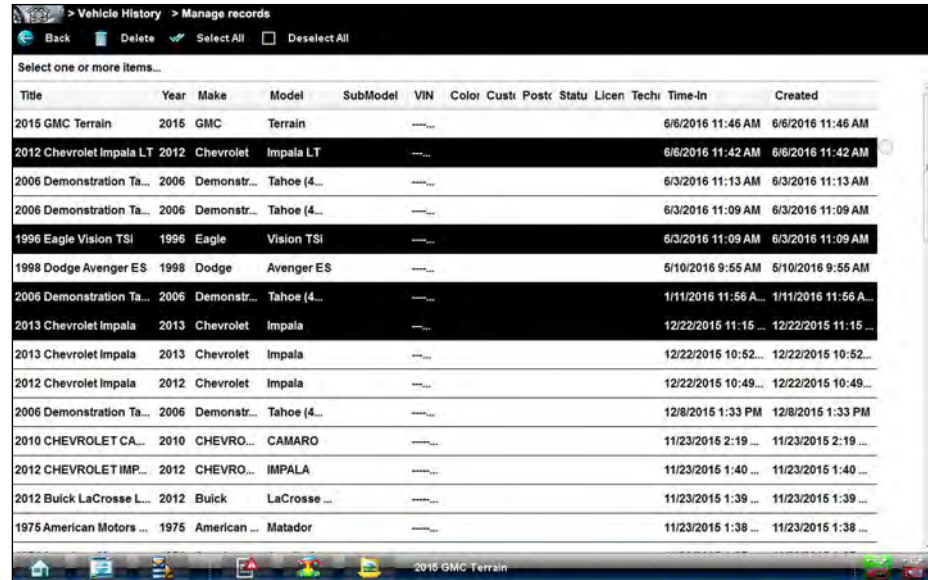

Figure 9-3

Search and Show All

Selecting Search opens a dialog box that allows you to search vehicle records by category. You can search for data in the following categories:

- Year
- Make
- Model
- Color
- Customer
- License
- State
- Technician

**To search:**

1. Select **Search** from the toolbar.
2. Enter the search criteria in the text field (Figure 9-4).

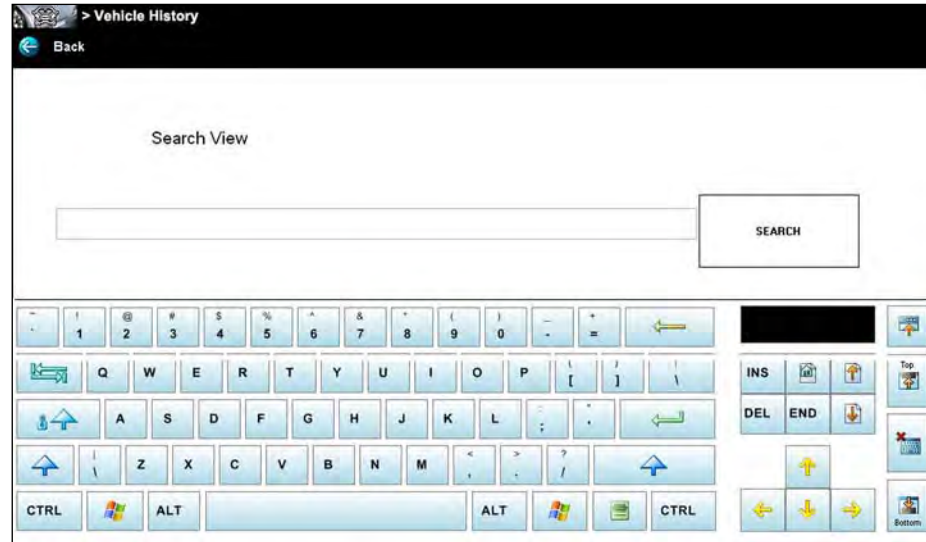

Figure 9-4 Sample Search dialog box

3. Select **Search** twice. The first tap closes the keyboard, the second tap starts the search. The display returns to the vehicle records list screen with only the records found in the search criteria showing.
4. Select **Show All** on the toolbar to restore the complete vehicle records list.

Settings

Use Settings to determine which categories display on the vehicle records list screen. Selecting the Settings icon opens a vehicle history category display menu.



To change Settings:

1. Select **Settings** to open the menu.

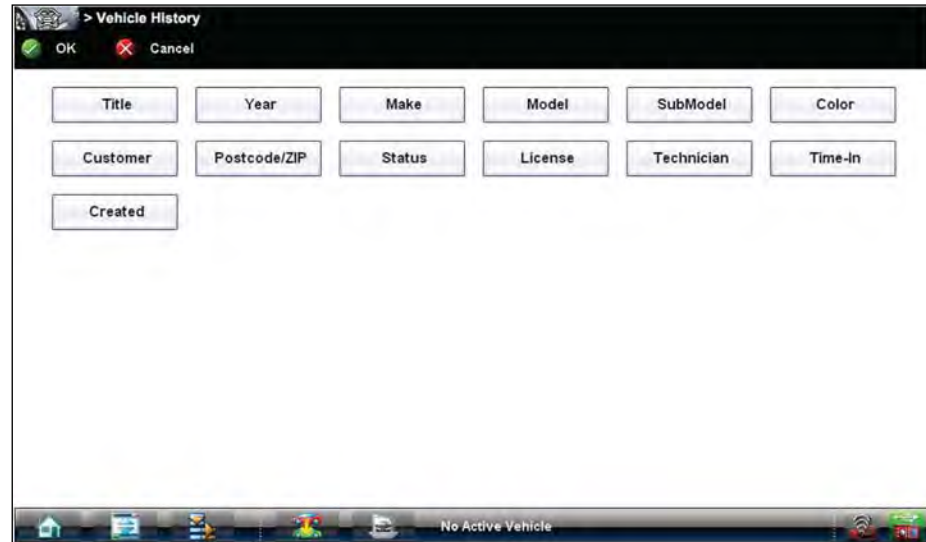

Figure 9-5 Sample Settings dialog box.

2. Select or deselect the desired categories:
 - Highlighted items - do not display
 - Non-highlighted items - display
3. Select **OK** on the toolbar to accept the changes, and return to the previous screen.

The Data Manager is used to store, sort, and review saved files. Most operations are controlled through the toolbar.

10.1 Screen Layout

Select **Data Manager** on the Module toolbar to open the file system. Use the toolbar at the top of the screen to navigate through the data. The folders panel below the toolbar displays the contents of the Windows *My Documents* > *ShopStream* folder, which is the Data Manager main screen. The information panel on the lower-left portion of the screen shows a summary of the saved file when available, and the preview panel on the lower right displays an image if the selected file is a graphic.

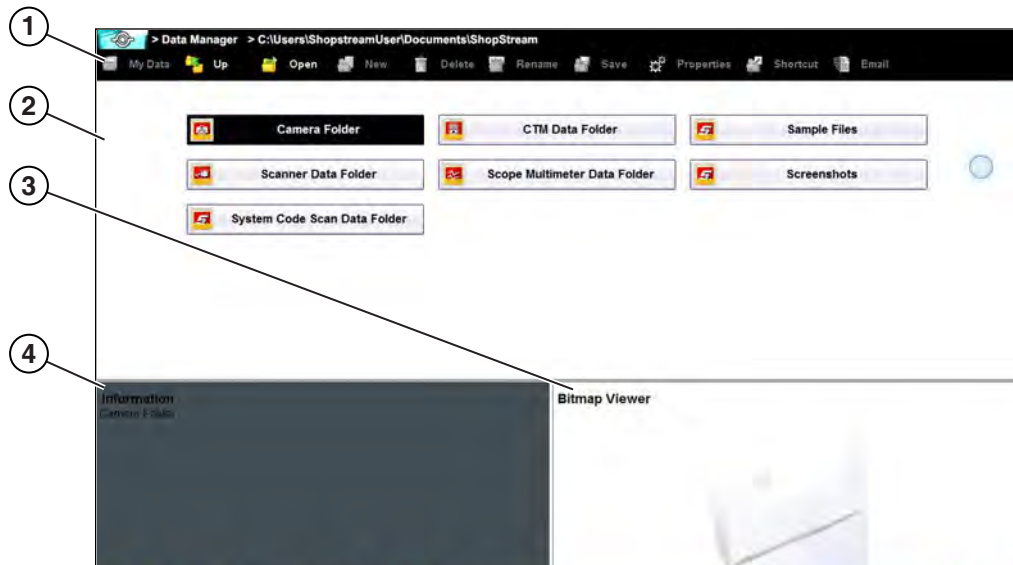

- 1— Data Manager Toolbar
- 2— Folders Panel
- 3— Preview Panel
- 4— Information Panel

Figure 10-1 Sample Data Manager main screen

The main screen includes folders for saved files from the various modules:









- Camera Folder—contains photographs taken with the built-in camera. See [Image Viewer](#) on page 157.
- CTM Data Folder—contains files saved while working in the Guided Component Test module. See [Scope Viewer](#) on page 156.
- Sample Files—contains an assortment of example saved data files.
- Scanner Data Folder—contains files saved while working in the Scanner function. See [Scanner DataViewer Operation](#) on page 146.

- Scope Multimeter Data Folder—contains files saved while working with the Scope Multimeter. See [Scope Viewer](#) on page 156.
- Screenshots—contains images saved by pressing the Shortcut (S) button. See [Image Viewer](#) on page 157.

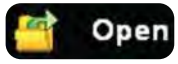
10.2 Navigation

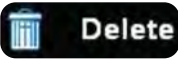
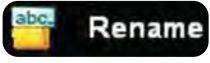
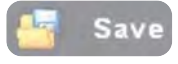
Use the toolbar icons as shown in the table below to navigate through the Data Manager:

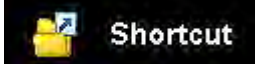
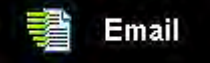
Table 10-1 Data Manager toolbar icons

Name	Icon	Description
My Data	 My Data	Returns to the Data Manager main screen.
Up	 Up	Moves the items displayed in the folders panel up one level in the file structure.
Open	 Open	Opens the highlighted folder or file.
New	 New	Creates a new folder.
Delete	 Delete	Moves the highlighted file or folder to the recycling bin.
Rename	 Rename	Opens a dialog box and the virtual keyboard for renaming the selected file or folder.
Save	 Save	The Save function is not implemented at this time.
Properties	 Properties	Opens a dialog box and the virtual keyboard for renaming the selected file or folder.
Shortcut	 Shortcut	Creates a shortcut to the highlighted item on the Data Manager main screen. See Shortcut on page 138 for information.
Email	 Email	Send data files as attachments, using Email. See Email on page 139 for information.
More (optional)		Opens hidden menu options

10.3 Operations

Data Manager operations based on toolbar selections are explained in the following sections.

10.3.1 My Data

The My Data icon is a shortcut that quickly returns you to the main Data Manager screen. Select the icon at any time to instantly return. Note the location of the page being viewed is shown near the top of the screen just above the toolbar.

10.3.2 Up

This icon reflects the items shown in the folders panel of the screen up in the file structure one level at a time. For example; one tap of the Up icon when viewing the contents of the Scanner Data Folder returns you to the main screen. A second tap would display the contents of the “My Documents” folder.

10.3.3 Open

The Open icon is only active (displays in color) when an item in the folders panel is highlighted.



To open a folder:

1. Highlight the file to open in the folders panel.
2. Select the **Open** icon to load the highlighted file.

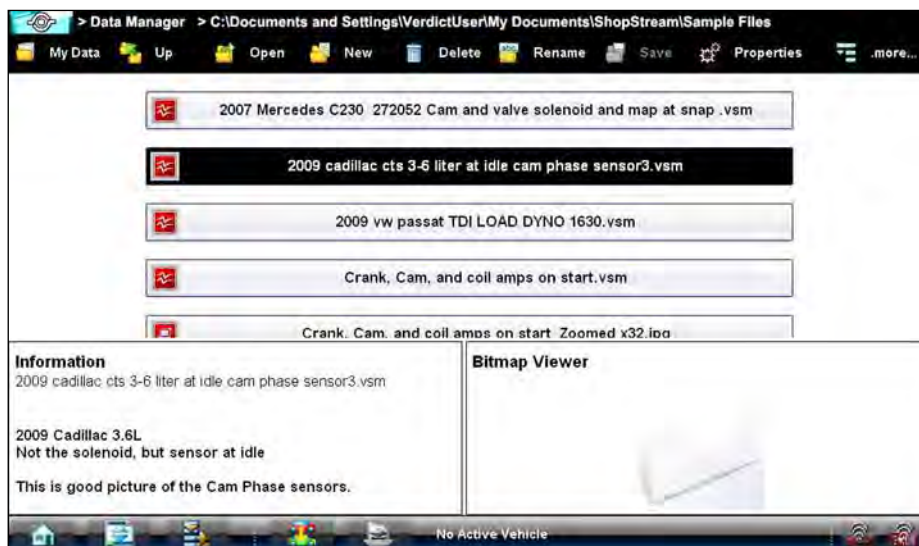

Figure 10-2 Sample open folder showing information

The screen advances and the contents of the open folder are shown in the folders panel. Highlight an item in the folders panel and the information or preview displays, if available, in the lower portion of the screen (Figure 10-2).

3. To exit the current folder:
 - Select **My Data** on the toolbar to return to the main Data Manager screen.
 - Select **Up** on the toolbar to return to the previous page.

10.3.4 New

The New icon allows you to create a new folder. This option is only available when the icon displays in color.



To create a new folder:

1. Select the **New** icon on the toolbar.
The New Folder Name dialog box opens (Figure 10-3).
2. Select the entry field on the dialog box to open the virtual keyboard.
3. Type a name for the new folder using the virtual keyboard.
4. Select the **OK** icon to create the new folder and return to the previous page. The **Cancel** icon returns you to the previous page without creating a new folder.



Figure 10-3 Sample New Folder name dialog box

10.3.5 Delete

The Delete icon moves folders or items within folders to the Recycling bin. A confirmation displays when a file is selected for deletion. Select **Yes** to delete the file or **Cancel** to exit.



To delete an item:

1. Select to highlight the item or folder to be deleted.
2. Select the Delete icon on the toolbar.

A confirmation message displays ([Figure 10-4](#)).



Figure 10-4 Sample delete confirmation message

3. Select **OK** to delete the selected item and return to the previous page. The **Cancel** icon returns you to the previous page without deleting the selected item.

10.3.6 Rename

The Rename icon allows you to change the name of a folder or items within a folder.



To rename an item:

1. Highlight the item or folder to be renamed.
2. Select the **Rename** icon on the toolbar.

The New Name dialog box opens (Figure 10-3).



Figure 10-5 Sample new name dialog box

3. Select the entry field on the dialog box to open the virtual keyboard.
4. Type the new name into the entry field using the virtual keyboard.
5. Select the **OK** icon to change the name and return to the previous page. The **Cancel** icon returns you to the previous page without changing the name.

10.3.7 Properties

The Properties icon function allows you to change the name and assign identifying attributes to saved Scope Multimeter files. Operation is similar to renaming a file as discussed above, except there are additional fields for entering descriptive information.



To assign properties to an item:

1. Highlight the item or folder.
2. Select the **Properties** icon on the toolbar.

The Properties dialog box and the virtual keyboard open (Figure 10-3).



Figure 10-6 Sample Properties dialog box without the virtual keyboard

3. Type a new name into the field using the virtual keyboard if you want to rename the file.
4. Use either the virtual keyboard or the dropdown menus to fill in the Year, Make, Component, and Condition fields.
5. Select the **OK** icon to change the name and return to the previous page. The **Cancel** icon returns you to the previous page without changing the name.

10.3.8 Shortcut

Selecting the **Shortcut** icon creates a shortcut to the highlighted item on the Data Manager main screen. A confirmation message "A shortcut has been created in the default folder for ***sample file name***" displays when this option is selected.

10.3.9 Email

Selecting the **Email** icon from the Data Manager toolbar allows you to send a saved data or image file as an attachment using e-mail. To use this feature, you must install an e-mail client, and then either link your existing e-mail address to the client, or create a new address. The following instructions are intended as a guide only.



To attach a file from a Data Manager folder to an e-mail:



NOTE:

The Email feature uses your system default email client. Refer to Windows Help for instructions on setting your default e-mail client. For an example on how to setup an e-mail client, see [E-mail client installation and setup \(Example\)](#): on page 140.



NOTE:

This diagnostic tool is equipped with Microsoft Outlook Express e-mail client. To use this client, open the Microsoft Outlook Express program and run the New Connection Wizard following the screen prompts, and then either create an e-mail account or use your existing account to complete the setup. You may be required to enter setup information (e.g. incoming and outgoing server names, types, and port values), contact your ISP and/or e-mail provider for additional information.

1. From the Data Manager main screen, select a file from within one of the folders (e.g. Camera, Scanner Data, Scope Multimeter, etc). In this example ([Figure 10-7](#)), a Scope data file was chosen.
2. With the file highlighted, select **Email** from the toolbar.

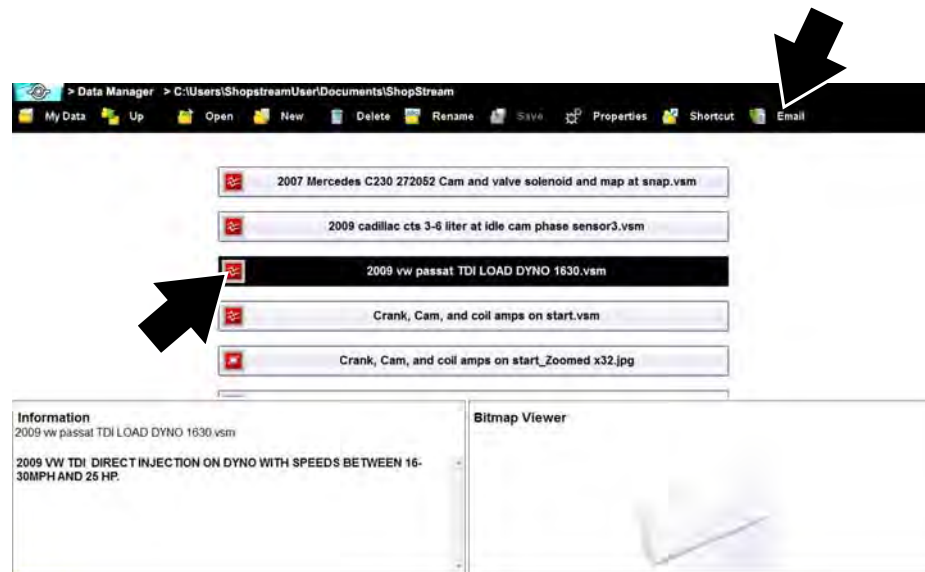

Figure 10-7

3. A new e-mail message window displays with the selected file attached ([Figure 10-8](#)).



NOTE:

If the e-mail message window does not appear, check the Windows taskbar.

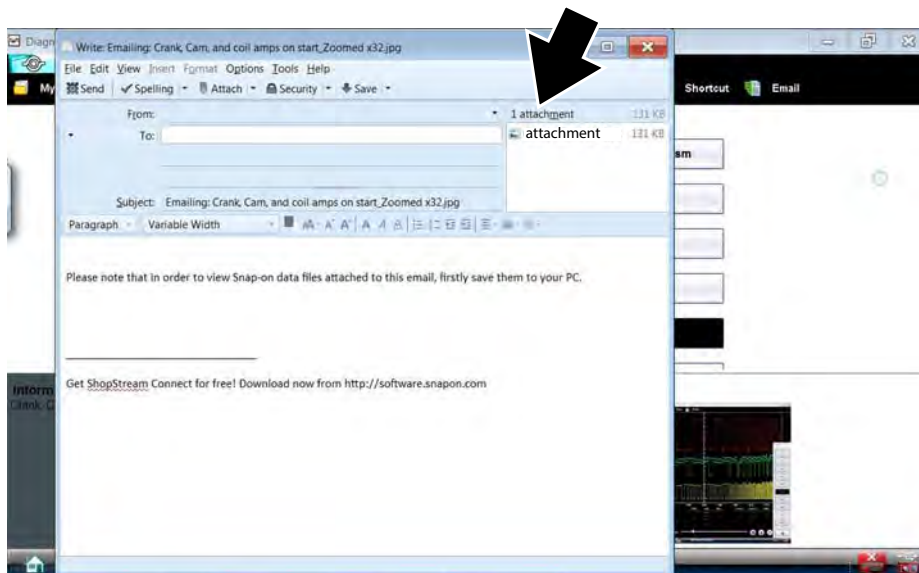

Figure 10-8

4. Enter the e-mail address of the recipient, and any other information needed.
5. Select the **Send** icon to send the e-mail.



NOTE:

You must have an Internet connection to send e-mail.



E-mail client installation and setup (Example):

The following instructions are intended as a guide only, as e-mail client setup procedures vary.

1. Download an email client (e.g. Mozilla Thunderbird) (Figure 10-9).

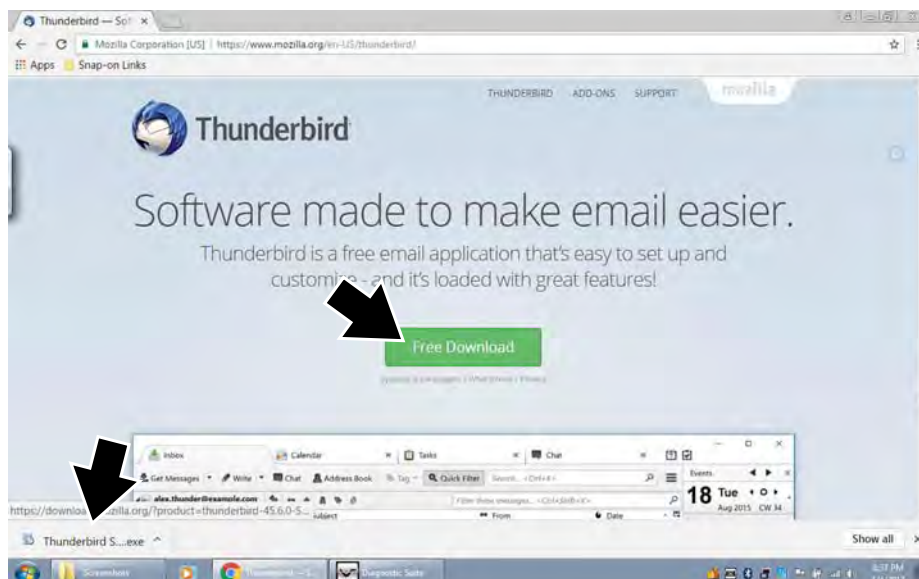

Figure 10-9

2. Install the software following the screen prompts (Figure 10-10).

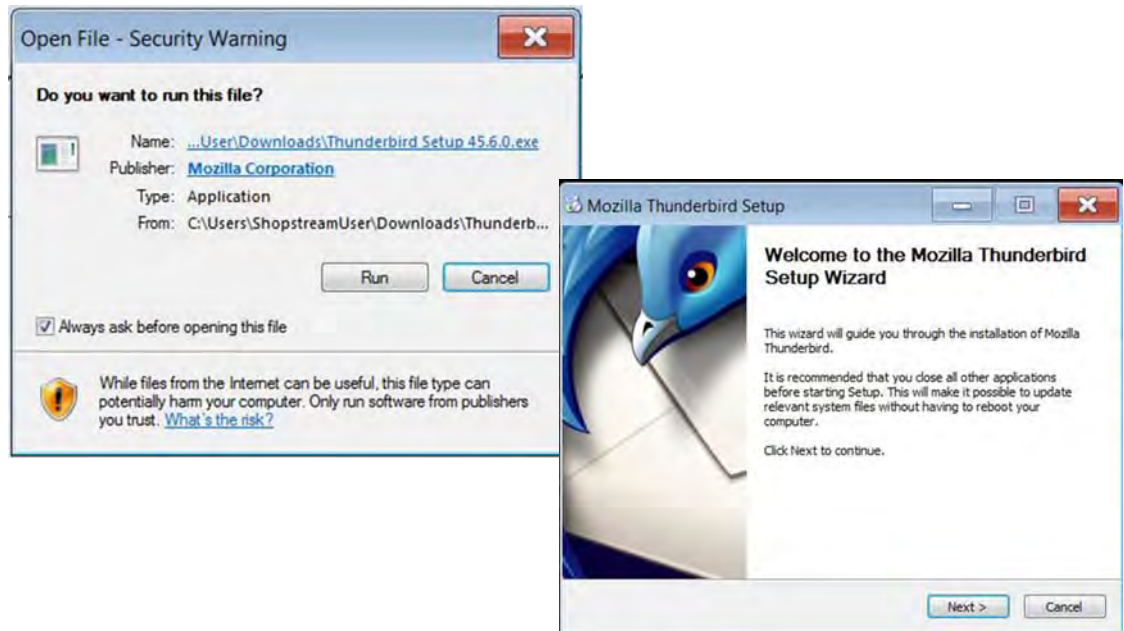

Figure 10-10

3. Continue through the setup. If available choose "set as my default mail application" (Figure 10-11).

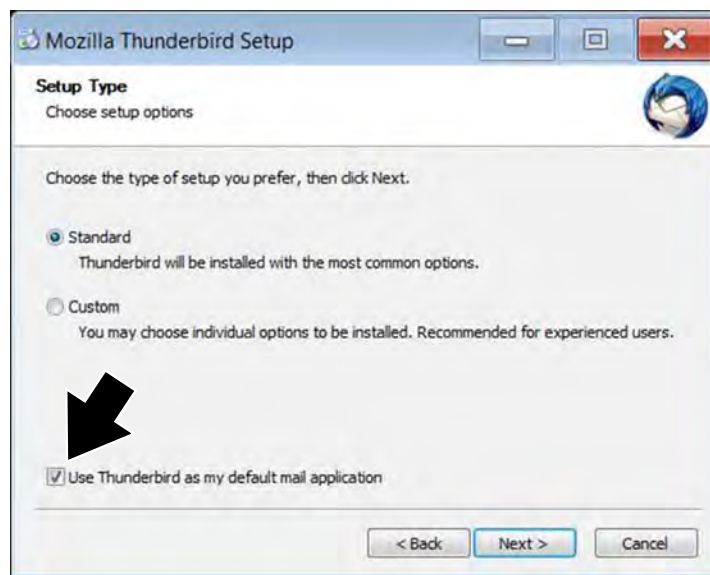

Figure 10-11

4. Choose to use your existing email address, or create a new email address with the email client (Figure 10-12).

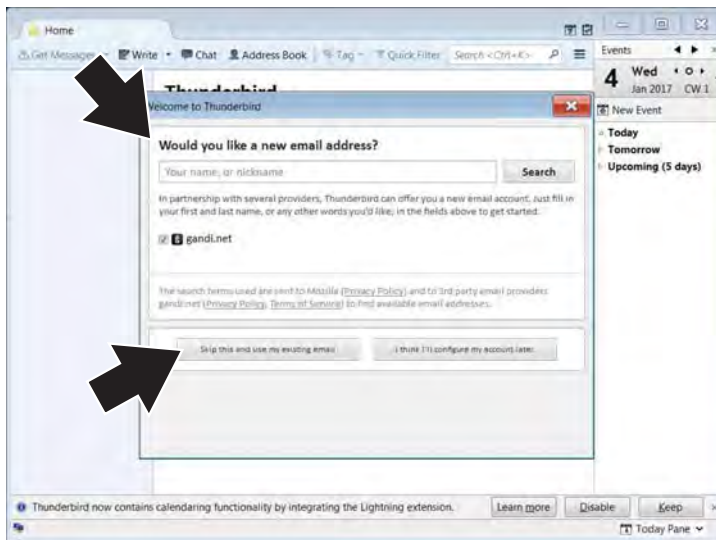

Figure 10-12

5. Enter your e-mail information as required (Figure 10-13).



NOTE:

E-mail client configuration settings should automatically be set during installation. If problems arise with the setup and manual configuration is needed, refer to the e-mail client help information and the Windows help information.



Figure 10-13

6. If your existing email provider login screen displays, enter your email address and password to allow the client to continue the setup with your provider (Figure 10-14).

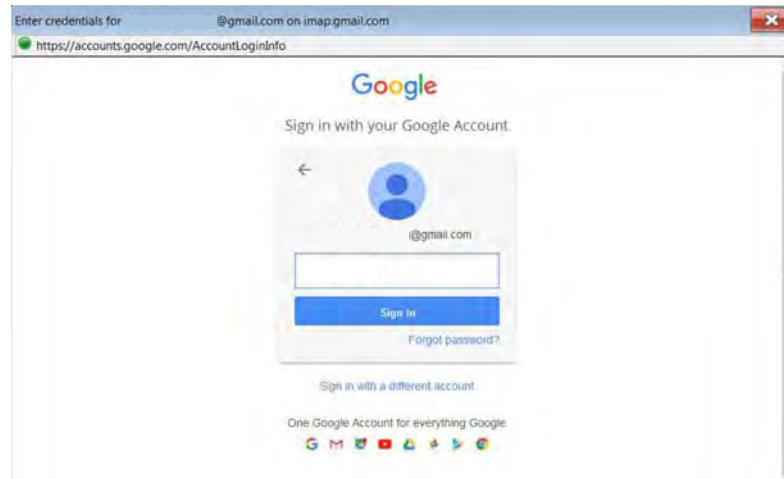

Figure 10-14

7. Follow the screen prompts to allow the client to link to your email address.
8. Once the client has successfully linked to your address, you can begin using the new e-mail client software on the diagnostic tool (Figure 10-15).

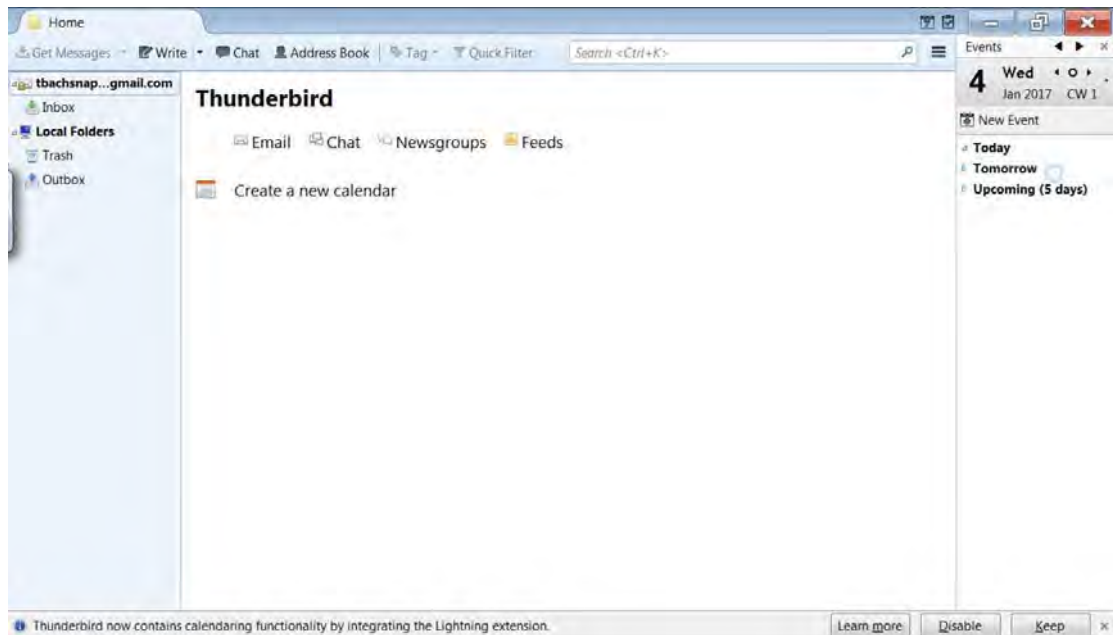

Figure 10-15

10.4 Vehicle System Report Data Folder

The Vehicle System Report Data Folder contains saved Code Scan (trouble code) files.

10.4.1 Vehicle System Report Data

Selecting the Vehicle System Report Data folder opens a list of the saved Code Scan (trouble code) files. To view a file, select it and use Adobe Reader to view and, or print the PDF file.

To add your shop contact information see, [Shop Information](#) on page 164.

The following example (Figure 10-16) shows a typical Vehicle System Report.

SampleShop
Your Address
Your City,
Your Phone Number

2002 Mustang 4.6L V8 EFI

Date: 1/11/2017

Vehicle System Report

VEHICLE INFORMATION

VIN	KT6
YEAR	2002
MAKE	Ford
MODEL	Mustang
ENGINE	4.6L V8 EFI
SYSTEM	

CODE SCAN RESULTS
Systems Analyzed: 20

- ⚠ Engine All Powertrain Codes Codes: 4
- ⚠ Transmission All Powertrain Codes Codes: 4
- ✅ Antilock Brakes Codes: 0
- ✅ Airbag Codes: 0
- ✅ Body Control Module Codes: 0
- ✅ Door Module Driver Codes: 0
- ✅ Door Module Passenger Codes: 0
- ✅ Heating & Air Conditioning Codes: 0
- ✅ Rear Auxiliary Climate Control Codes: 0
- ✅ Rear Heating & Air Conditioning Codes: 0
- ✅ Instrument Panel Cluster Codes: 0
- ⚠ Passenger Presence System Codes Codes: 2
- ✅ Radio Codes: 0
- ✅ Seat Module Codes: 0
- ✅ Suspension (ESC) Codes: 0
- ✅ Theft Deterrent Codes: 0
- ✅ Tire Pressure Monitor Codes: 0

Date: 1/11/2017

- ⚠ OBDII Codes: 4

Engine All Powertrain Codes Codes: 4
 P0101 | Mass Air Flow Circuit Out Of Range
 P0455 | EVAP System Leak (Large)
 P0171 | Fuel System Too Lean Bank 1
 P0420 | Catalyst Efficiency Low Bank 1

Transmission All Powertrain Codes Codes: 4
 P0101 | Mass Air Flow Circuit Out Of Range
 P0455 | EVAP System Leak (Large)
 P0171 | Fuel System Too Lean Bank 1
 P0420 | Catalyst Efficiency Low Bank 1

Antilock Brakes Codes: 0

Airbag Codes: 0

Body Control Module Codes: 0

Door Module Driver Codes: 0

Door Module Passenger Codes: 0

Heating & Air Conditioning Codes: 0

Instrument Panel Cluster Codes: 0

Passenger Presence System Codes Codes: 2
 B1022 | Driver Loop Resistance Low
 B1061 | Lamp Circuit Failure

Radio Codes: 0

Seat Module Codes: 0

Suspension (ESC) Codes: 0

Theft Deterrent Codes: 0

Figure 10-16

10.5 Viewing Saved Files

As mentioned in the beginning of this section, the data and image files in the Data Manager folders are also accessible from the Windows *My Documents* > *ShopStream* folder. You may access, copy or move the files you save in the ShopStream Diagnostic Suite program from the folder at anytime.

The files may also be transferred to portable USB drives and then transferred to your PC. All copy, move and save functions are accomplished using standard Windows operations.

Camera images and screenshots are saved as JPEG files and are viewable on most PCs. Data files are saved using propriety file extensions and are not viewable on a PC without the use of ShopStream Connect. See [ShopStream Connect™](#) on page 145 for additional information.

10.5.1 ShopStream Connect™

Data files saved on your diagnostic tool are designed and intended to be reviewed using the Data Manager functions as described earlier. An alternative method can be used to review select data files on a PC using ShopStream Connect.

ShopStream Connect is PC-based program that allows you to manage, view and print data files using a PC. ShopStream Connect is a free program available for download from our website. See the contact information at the front of this manual for website information.

10.6 Saved File Structure

The Diagnostic Suite automatically creates folders to manage saved files. Whenever 60 files are saved into any of the Data Manager menu option folders, a new folder is created. Folders may contain files for a day, week, month, or a year. An older folder, when available, goes to the next higher level in the files structure menu ([Figure 10-17](#)).

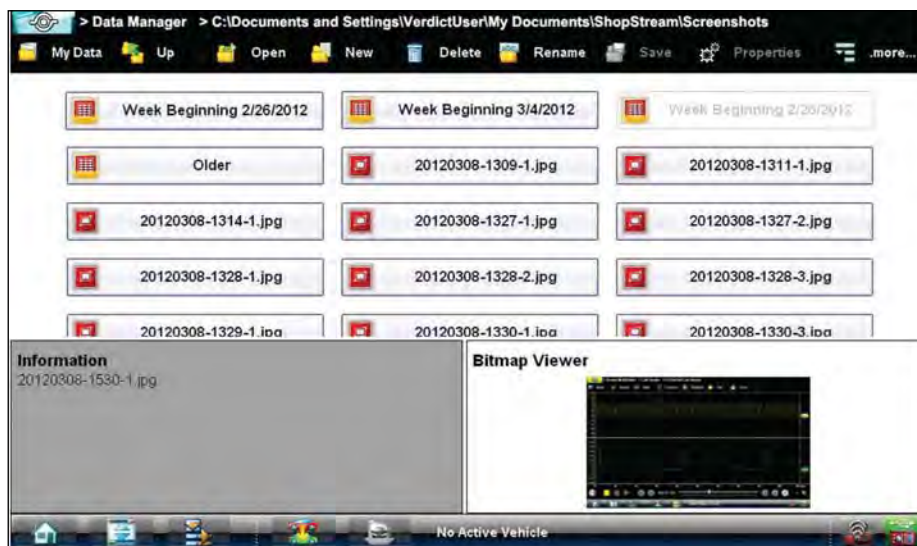
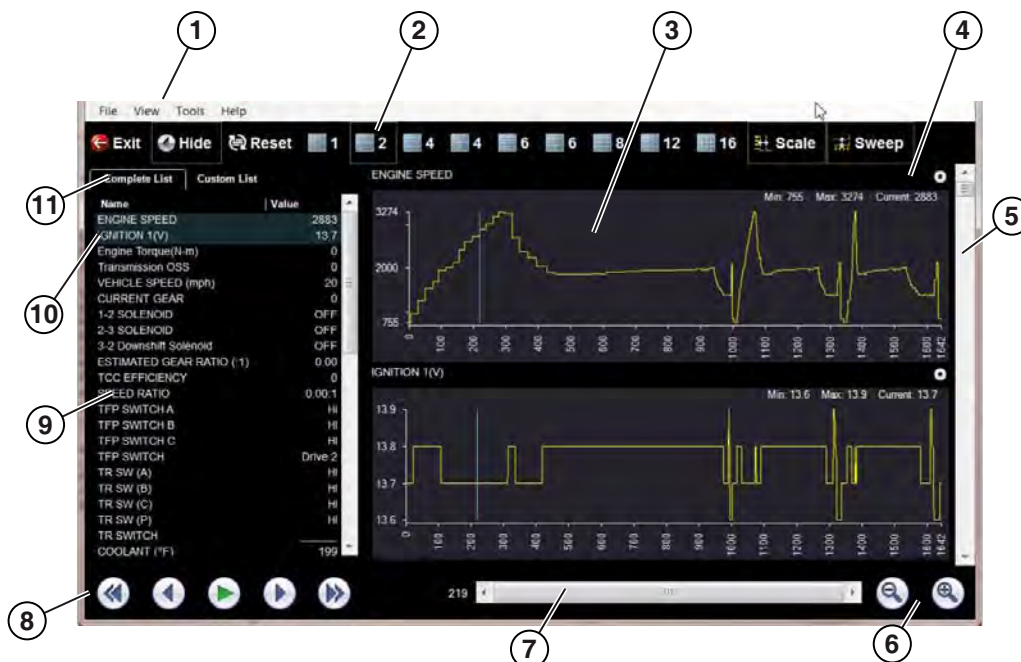

Figure 10-17 Sample saved file folder structure

10.7 Scanner DataViewer Operation

The Scanner DataViewer allows you to review saved scanner data files (Figure 10-18). To open saved Scanner data files, select the **Scanner Data Folder** menu option from the Data Manager main menu.

Scanner DataViewer - Opens .pids, .scm, .scs, .scp and .spm file extensions



- 1— Menu bar
- 2— Display toolbar
- 3— Graph display
- 4— Properties icon
- 5— Vertical Scroll bar
- 6— Zoom controls
- 7— Slider bar
- 8— Navigation toolbar
- 9— Parameter text list
- 10—Parameter configuration tabs

Figure 10-18 Scanner Data Viewer

10.7.1 Menu Bar

The menu bar at the top of the screen contains the File, View, Tools, and Help menus.

File Menu

The File menu offers the following selections:

- **Load**—locate and open data files, launches a navigation window
- **Print**—print selected pids
- **Print Preview**—preview pids before printing
- **Exit**—closes Scanner DataViewer

When Print or Print Preview is selected, a dialog box opens and allows you to define the printed output. Print settings include, print as graphs or text, which pids to include, number of pids per page, display colors, and the text font (Figure 10-19).



Figure 10-19 Pids print settings



To print:

1. Select the desired pids. A checked box indicates the pid will be printed. Select again to deselect the pid.
2. Select Change to modify the font, this opens a standard Windows font dialog box.
 - a. Modify the font as desired.
 - b. Select **OK** to close the font dialog box.
3. Once all selections are made, select **OK**.
A print dialog box opens.
4. Select **OK**.
 - a. If Print was selected, the file is sent to the printer.
 - b. If Print Preview was selected, a preview window opens. Select the printer icon (Figure 10-20) to send the file to the printer.

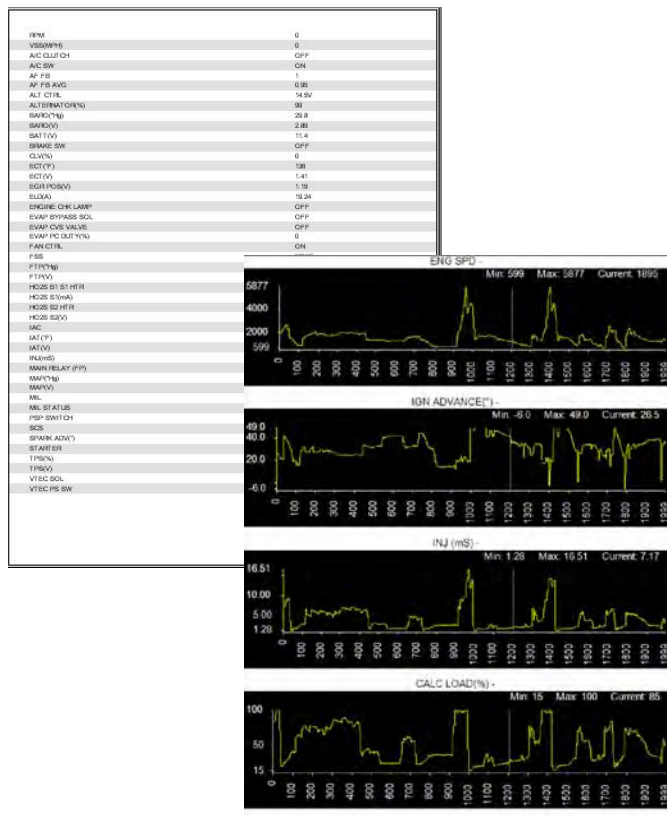

Figure 10-20 Print preview window (text list and graphs examples)

View Menu

The View menu allows you to change how data is displayed on the screen (Figure 10-21).

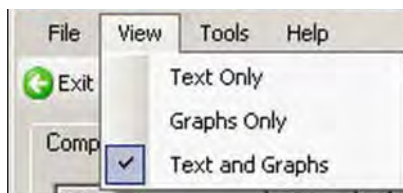

Figure 10-21 Scanner DataViewer View menu

Select from the following menu options:

- **Text Only**—shows all parameters and their values as text only
- **Graphs Only**—shows all parameters as graphs only
- **Text and Graphs**—shows all parameters and their values as text in the left panel of the screen, and shows them as graphs in the right panel of the screen

Tools Menu

The Tools menu opens the Properties dialog box.

The Properties dialog box has two sections (Figure 10-22); Shared Graph Properties and Individual Properties. Shared Graph Properties apply to all graphs and Individual Properties apply to the selected graph only.

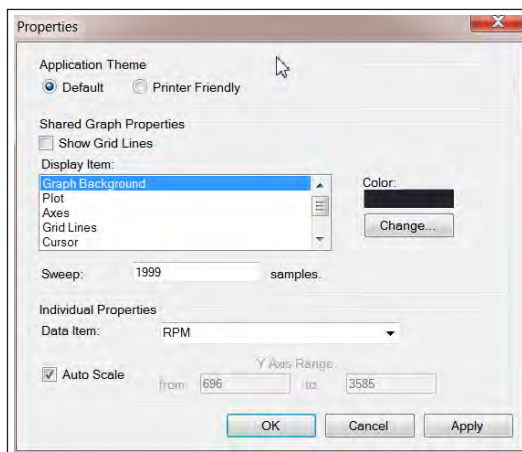

Figure 10-22 Properties dialog box

Properties dialog box selections include:

- **Grid Lines**—when selected, a line displays at each major division of the graphs.
- **Display Item**—use to view the display color of the listed items. Highlight an item and the current color appears in the Color box.
- **Change**—use to change the color of the highlighted item, select to open a color palate.
- **Sweep**—use to adjust the number of data frames that appear on the screen (zoom in or out), highlight and type in the desired number.
- **Reset Colors**—use to restore the default color settings.
- **Data Item**—use this pulldown menu to select individual graphs for modification.
- **Auto Scale**—minimum and maximum (Y axis) values automatically adjust to the signal when the box is checked, uncheck the box if you want to custom set the values.
- **Y Axis Range**—use to type desired minimum (from) and maximum (to) values in the selection boxes. This field is only active when Auto Scale is deselected.
- **OK**—applies the changes and closes the properties dialog box.
- **Cancel**—closes the properties dialog box without making changes.
- **Apply**—applies the changes and leaves the properties dialog box open.



NOTE:

The Properties icon on each graph also opens the Properties dialog box (Figure 10-18).

Help Menu

The Help menu provides Scanner Viewer software version information.

10.7.2 Display Toolbar

The Display toolbar provides the following controls (Figure 10-23).

- **Exit**—closes Scanner DataViewer.
- **Hide PID List**—toggles display between parameter text and graph views.
- **Display Views (1 to 16)**—determines how many graphs display at a time.
- **Scale**—switches the scale values shown to the left of the graph off and on.
- **Sweep**—switches the sweep values shown below the graph off and on.

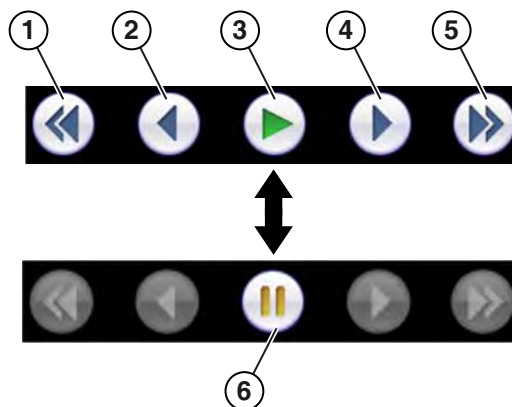

Figure 10-23 Display toolbar

10.7.3 Navigation Tools

Playback Controls

The playback controls allow you to navigate through saved data (Figure 10-24).



- 1— **Skip Back**—Allows backward movement in multiple steps.
- 2— **Step Back**—Allows backward movement in singular steps.
- 3— **Play**—Select to play.
- 4— **Step Forward**—Allows forward movement in singular steps.
- 5— **Skip Forward**—Allows forward movement in multiple steps.
- 6— **Pause**—Select to pause playback.

Figure 10-24 Playback controls

Zoom Controls

The zoom controls allow you to incrementally increase or decrease the screen magnification (Figure 10-25).

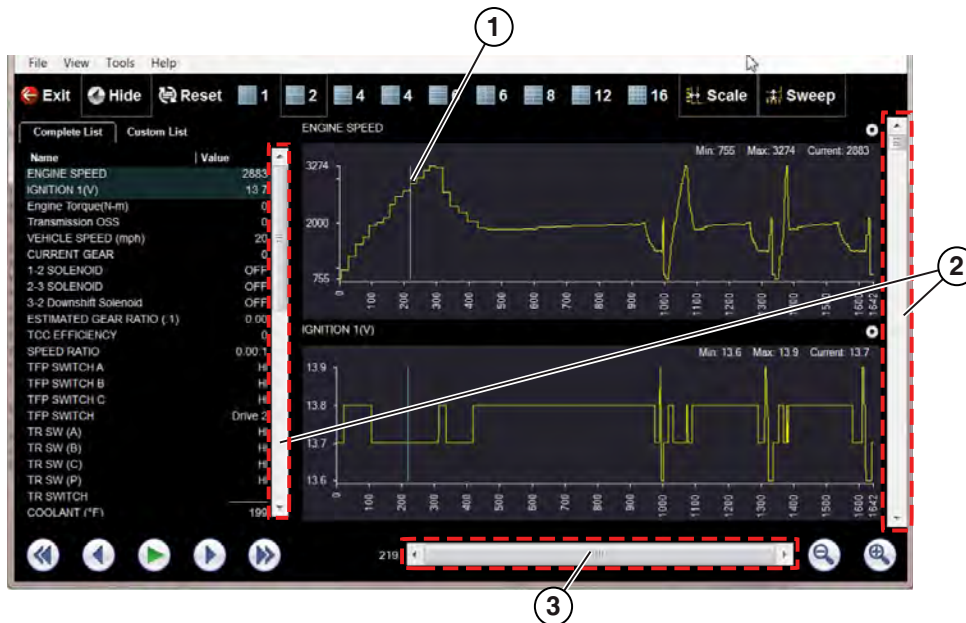

Figure 10-25 Zoom controls

Slider / Scroll Bars and Cursor

Use the slider bar to quickly navigate through the data (Figure 10-26). During playback the number displayed on the left side of the slider bar indicates the current position of the cursor in the data file. The cursor can be repositioned during playback or when paused, by selecting and dragging.

Use the scroll bar (right side) to vertically scroll through the parameter list and graphs.



- 1— Cursor
- 2— Scroll bar
- 3— Slider bar

Figure 10-26

10.7.4 Customizing the Display

The parameter text list (left side) displays parameter names and current values.

The display can be customized by selecting and dragging parameters from the text list or graph display (Figure 10-27). The highlighted parameters in the text list indicate which parameters are displayed as graphs.



NOTE:

The parameter text list is sortable by name and value. Select Name or Value at the top of the list to change the sorted view.



Figure 10-27

10.7.5 Customizing the Parameter List

1. The parameter configuration tabs allow you to choose between displaying all available parameters (Complete List), or only those from a (Custom List) (Figure 10-28).



To customize the parameter list:

1. Select the **Custom List** tab (Figure 10-28).
2. Select **Edit List** in the custom window.



1— Edit List

2— Custom List tab

Figure 10-28

- A list of available parameters displays (Figure 10-29).
3. Select the parameters to include in your custom list. Select All and Deselect All controls are also available to assist in the selection process.



Figure 10-29 Creating a custom parameter list

4. Select **Save & Exit** to close the window.
Only the parameters selected in your custom list are displayed.

10.8 Scope Viewer

This section is intended as an introduction of the Scope Viewer, as many features are similar to the Scope module features. The Scope Viewer allows you to print and playback recorded trace signals captured on your diagnostic tool. When a scope file is selected, it opens and displays in the Scope File Viewer.

The Scope Viewer allows you to print and playback recorded trace signals captured on your diagnostic tool. When a scope file is selected, it opens and displays in the Scope File Viewer.

The Scope File Viewer is intended to be used to review scope and meter files originally captured on a diagnostic tool. Some features (control icons) of the Scope File Viewer may not be available “grayed out”. This is normal as those features are only applicable when viewing live data on a diagnostic tool.

The Scope File Viewer screen includes the following sections:

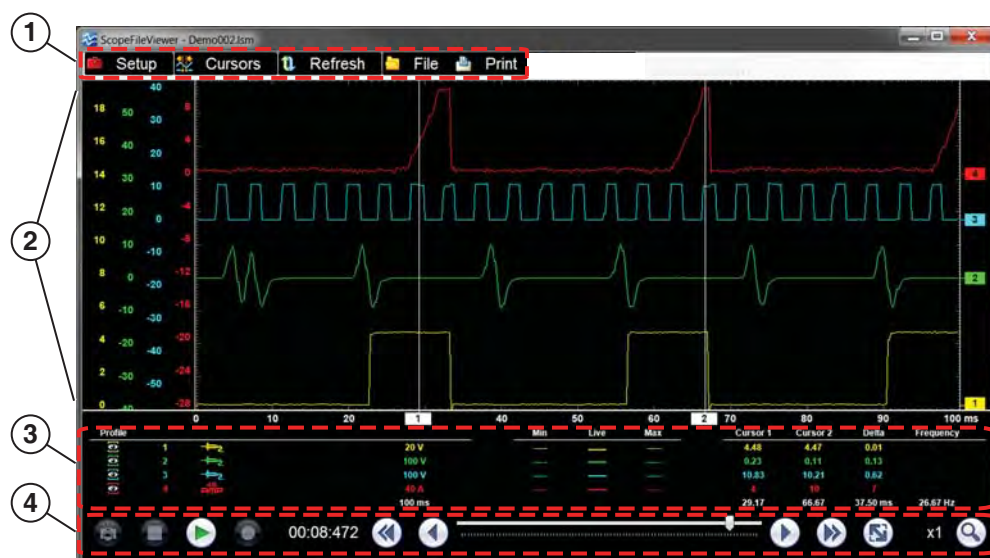

Figure 10-30

- 1— Toolbar - contains control icons**
- 2— Main Body - displays recorded trace results**
- 3— Profile Controls Window - displays profile control icons and trace display settings**
- 4— Playback Control Toolbar - contains playback and display controls**

10.9 Image Viewer

The Image Viewer allows you to open and view image files and screenshots.

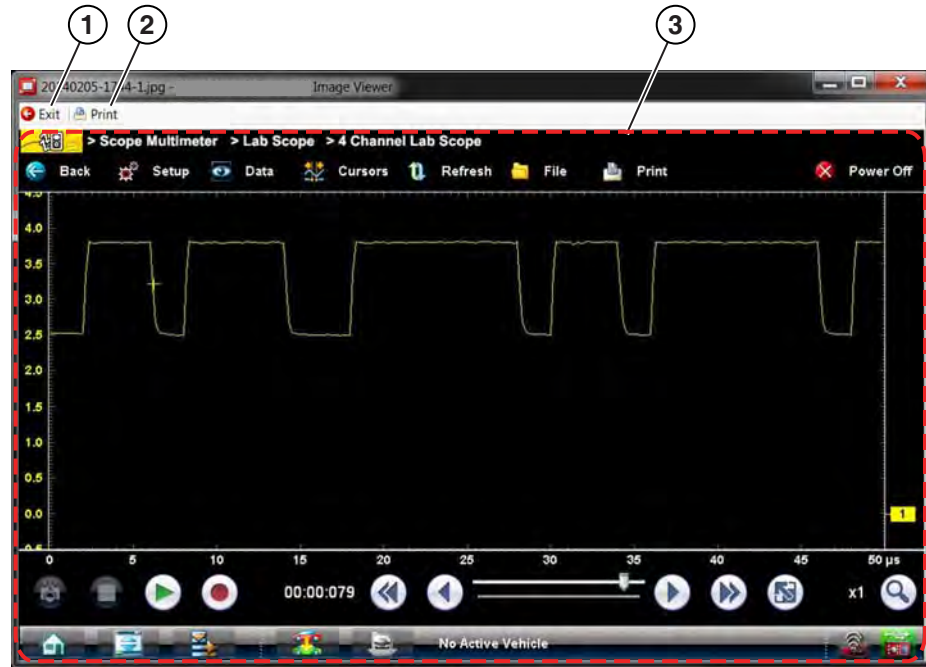

Figure 10-31

- 1— Exit - closes the Image Viewer
- 2— Print - prints the image
- 3— Captured Screen Image









Selecting **Help** from the Home screen opens this manual in a dedicated screen viewer. Navigate through the file either by gesture scrolling on the touch screen, or with the scroll bar along the right edge of the viewing screen. A left-to-right scroll bar appears at the bottom of the screen when magnification is increased.

All listings in the Contents and Index are active links. Select an entry with the stylus to go directly to that point of the document. Additional links within the text, shown in blue-colored type, also take you to the referenced section of the manual.

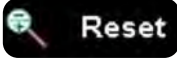
11.1 Using the Help Toolbar

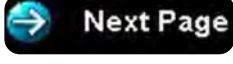
A simple toolbar at the top of the screen is used to adjust screen magnification and to exit Help:

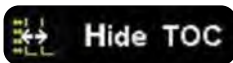
Table 11-1 Help toolbar icons

Name	Icon	Description
Back		Closes the help file and returns you to the previously viewed screen.
Zoom +		Incrementally increases the screen magnification.
Zoom –		Incrementally decreases the screen magnification.
Reset		Restores the default screen magnification.
Previous Page		Moves back one page in the document.
Page Counter		Shows the current page over the total number of pages in the document.
Next Page		Moves forward one page in the document.
More		Opens a menu of the additional options (Hide TOC or Show TOC) shown below.
	Hide TOC	
		Closes the contents and search column so the document fills the screen.
	Show TOC	
		Opens the contents and search column if they have been hidden.
Exit		Closes the help file, and any other open modules, and returns you to the Home screen.

Selecting System Settings from the Home screen opens a menu with two options:

- [Paired Devices](#) - Paired Devices allows you to check the status and pair wireless devices to the diagnostic tool.
- [Shop Information](#) - Shop Information allows you to create and edit a personalized header that is included on printed documents.
- [Data Backup](#) - Data Backup provides two options, backup and restore.

12.1 Paired Devices

Wireless devices communicate with the diagnostic tool to allow you work and access data remotely while working on a vehicle. Wireless devices such as the Scan Module and optional M2 Scope/Meter need to be paired, or synchronized, the first time they are used together.



To check the devices paired to your diagnostic tool:

1. Select **System Settings > Paired Devices**.









The paired devices screen opens ([Figure 12-1](#)).

The Paired Devices screen lists all of the devices paired to the diagnostic tool, and also indicates whether or not there is active communication occurring.



Figure 12-1 Typical Paired Devices screen

The Hardware Status indicators in the lower-right corner of the Home screen provide a quick reference to wireless device operations. The background color of the status indicator icon represents the condition of the wireless connectivity to that device. Icon status is shown in the table below:

Hardware Icon	Background Color	Condition	Action
Scan Module			
	Red	Not Paired	Pair the Scan Module to the diagnostic tool. See Pairing The Scan Module on page 66 for instructions.
	Grey	Paired, but Not Communicating	You may have moved out of range. Move the diagnostic tool closer to the Scan Module to reestablish communications. If connectivity is not restored, perform the Recovery Procedure on page 72.
	Blue	Paired and Communicating	Hardware status is good and Bluetooth should be functional. Verify that the green Bluetooth LED on the front of the Scan Module is flashing. If there is no connectivity, perform the Recovery Procedure on page 72.
	Green	USB Cable Connected	Indicates the USB cable is connected.
	Gray	USB Cable Not Connected	Indicates the USB cable is not connected or connected but not allowing communication
M2 Scope/Meter (optional)			
	Red	Not Paired	Pair the M2 to the diagnostic tool. See Pairing the M2 Scope/Meter (optional equipment) on page 161 for instructions.
	Grey	Paired, but Not Communicating	You may have moved out of range. Move the M2 closer to the diagnostic tool to reestablish communications.
	Blue	Paired, and Communicating	Hardware status is good and Bluetooth is communicating.

12.1.1 Scan Module Pairing

For detailed information on the use and pairing of the Scan Module, see [Scan Module Operation](#) on page 65.

12.1.2 Paring the M2 Scope/Meter (optional equipment)



NOTE:

The M2 Scope/Meter is optional equipment for use with some diagnostic tools and may not be applicable or included with your diagnostic tool kit. For detailed operation instructions, see the M2 Scope/Meter instructions supplied with your M2 and/or diagnostic tool. M2 operation instructions can also be found on our website, see the Contact Information section in the front of this manual for website address information.

Pairing is the wireless connection (identification) process used to connect the M2 Scope/Meter to your diagnostic tool. The M2 Scope/Meter needs to be paired (connected) to the diagnostic tool for remote operation.

The M2 Scope/Meter only needs to be paired once before it's initial use. The connection configuration should remain in memory for all future uses. If the connection configuration is removed or lost the pairing procedure will need to be repeated.

Before pairing, make sure the M2 Scope/Meter and the diagnostic tool have fully charged batteries, or are connected to their AC/DC power supplies. It is highly recommended that both devices be powered by their respective AC/DC power supplies during the paring operation. The two devices to be paired should also be in close proximity to each other, and in an area that is relatively free of radio frequency interference.



NOTE:

The M2 Scope/Meter can only be paired with one diagnostic tool at a time. If applicable, remove or disconnect the M4 Scope module before connecting and pairing the M2.



To pair the M2 Scope/Meter with the diagnostic tool:

1. Turn on the diagnostic tool and M2 Scope/Meter.
2. Set the M2 Scope/Meter **Rotary Switch** to the **oscilloscope** position.
3. Press and hold the **F1** key of the M2 Scope/Meter to open the alternate menu. An alternate menu option for the F4 key is now displayed.
4. Press the **F4** key (once) to enable Bluetooth Discovery. Enabling Bluetooth Discovery allows the M2 Scope/Meter to be identified and paired to the diagnostic tool.

The F4 field on the screen switches to inverse video (white on black) when the Bluetooth Discovery mode becomes enabled (Figure 12-2).

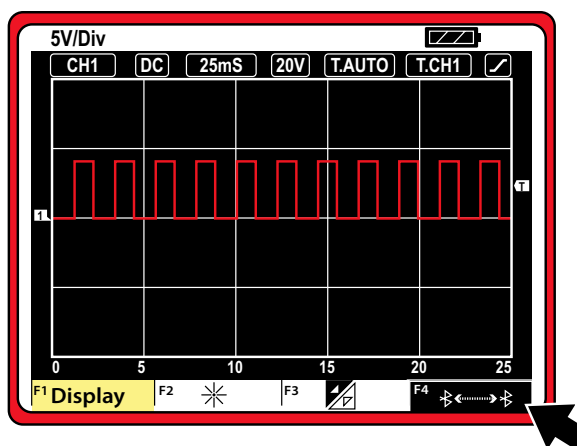

Figure 12-2 Bluetooth Discovery (shown enabled "on")

5. With Bluetooth Discovery enabled, turn the M2 Scope/Meter Rotary Switch to the Remote Functions position (Figure 12-3).

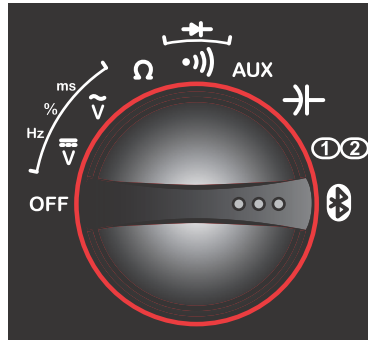

Figure 12-3 Rotary switch Remote Functions setting

6. Select the **System Settings** icon on the Home screen of the diagnostic tool.
7. Select **Paired Devices** from the menu.
8. From the Paired Devices menu select **Add** from the toolbar.
9. When prompted select **OK** from the toolbar.

The diagnostic tool searches for compatible wireless devices, then displays the results. The M2 Scope/Meter is typically listed as “VERDICT M2-” plus six digits of the unit’s serial number.
10. Select the **M2 Scope/Meter** from the search results list (Figure 12-4).



Figure 12-4 Typical Device selection

A “in progress” message displays during the pairing procedure, which takes several seconds. The Paired Devices screen displays once the procedure completes (Figure 12-5).



Figure 12-5 Typical Paired Devices screen

11. Select the **Home** icon on the toolbar to return to the Home screen.M2 Scope/Meter
12. After the M2 Scope/Meter has been successfully paired, turn the M2 Scope/Meter **Rotary Switch** to the **oscilloscope** position.
13. Press and hold the **F1** key to open the alternate menu.
14. Press the **F4** key (once) to turn off (disable) Bluetooth Discovery mode.

The F4 field on the screen switches to normal video (black on white) when the Bluetooth Discovery mode is inactive (Figure 12-6).

Once the M2 Scope/Meter is initially paired with the diagnostic tool, additional pairing is not necessary. Although the discovery mode has been disabled, the two-paired devices automatically seek and find each other when they are both powered on. The M2 Scope/Meter becomes “invisible” to other Bluetooth devices whenever Bluetooth Discovery is disabled.

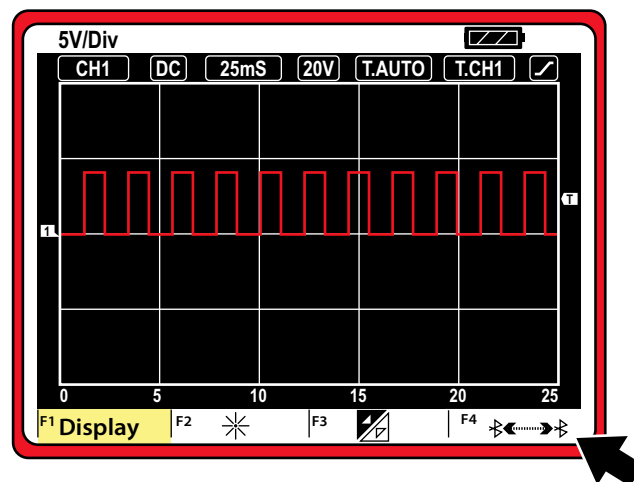

Figure 12-6 Bluetooth Discovery (shown disabled “off”)

12.2 Shop Information

This option allows you to add personalized shop information that can be included on printed data files. Selecting opens a form that can be filled in using the virtual keyboard. Select OK when the form is complete and the information is saved.



To add Shop Information:

1. From the Home screen select **System Settings**.
2. From the System Settings menu select **Shop Information**.

The Shop Information dialog box opens ([Figure 12-7](#)).

Figure 12-7 Sample Shop Information dialog box

3. Select within any of the information fields and the virtual keyboard opens.
4. Use the virtual keyboard to fill in the Shop Information form.
As an alternative, you can connect a USB keyboard to a USB jack on the diagnostic tool and use it to enter information into the form.

**NOTE:**

The screen does not scroll. Use the Top and Bottom icons on the right side of the virtual keyboard to relocate the keyboard on the screen so that you can complete the form (Figure 12-8).

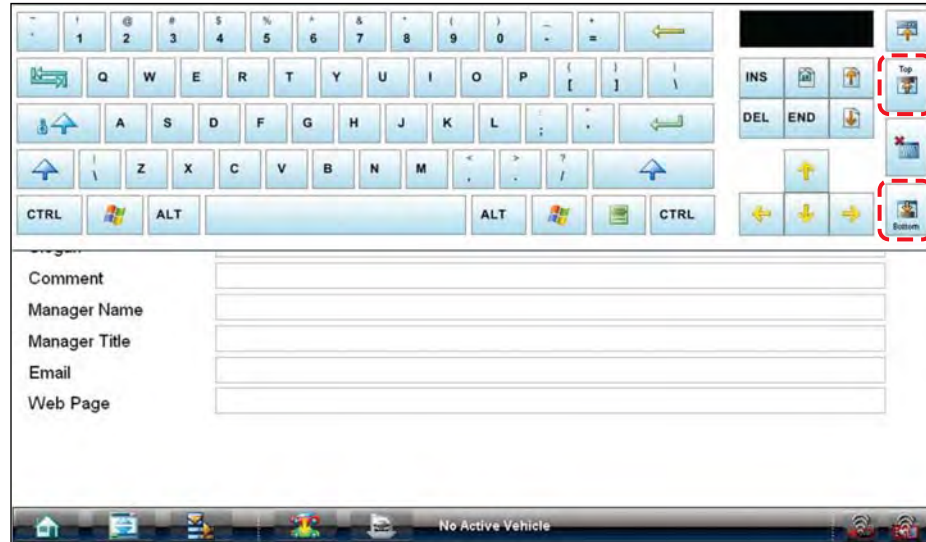

Figure 12-8 Virtual keyboard Top and Bottom icons

5. Close the virtual keyboard and review the information once all the fields have been filled in.
6. Select **OK** from the toolbar to save the Shop Information, or **Cancel** to close the Shop Information dialog box without saving.

The Shop Information screen closes and the screen returns to the System Settings menu.

12.3 Code Scan (Timestamp)

Selecting **Code Scan** from the Systems Settings main menu allows you to hide/show the timestamp (time of day) on the Vehicle System Report.

Select the **On/Off** checkbox, then select **OK** from the toolbar to confirm the setting (Figure 12-9).

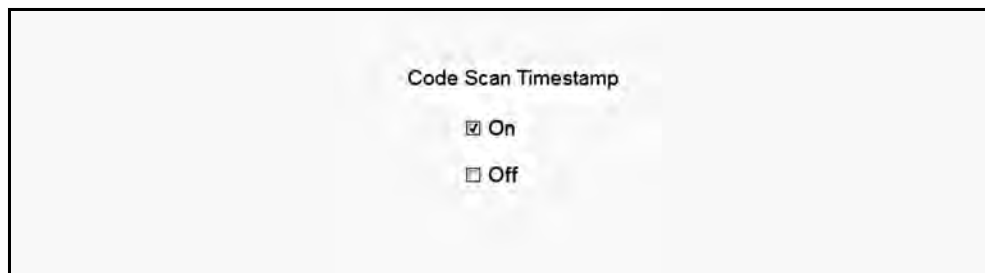

Figure 12-9

12.4 Data Backup

Selecting **Data Backup** from the Systems Settings main menu provides the following options:

12.4.1 Backup Settings (message)

Backup Setting allows you to choose the interval for displaying the backup reminder message, or turn the reminder off. Message options are:

- Every Week
- Every 2 Weeks
- Every 4 Weeks
- Never

12.4.2 Backup

The Backup option allows you to back up your saved data to a file on the internal hard drive, or to an external drive (e.g. USB flash drive). This option can be used as general maintenance to ensure you have a safe backup of your saved data, or if a issue occurs where a system restore is necessary and you need to retain your saved data. The following types of data are backed up:

- ShopStream Data (saved movie/data files)
- Lab Scope Settings (presets)
- Vehicle History Records and Favorites



To Backup Information:

1. From the Home screen select **System Settings**.
2. From the System Settings main menu select **Data Backup > Backup**.
The destination drive dialog box opens ([Figure 12-10](#)).
3. Select a drive destination.



NOTE:

Drive designations (e.g. E:/, F:/ etc.), are only visible when external drives are connected to the diagnostic tool.

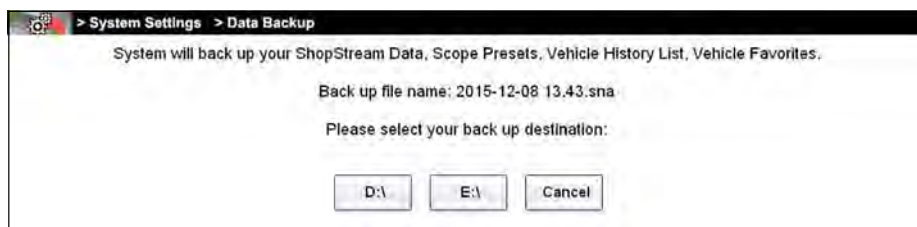

Figure 12-10

A progress screen is displayed as the backup file is saved to the root of the drive selected with a file extension of .sna. Then a confirmation screen is displayed.

4. Select **OK** to complete the procedure.

12.4.3 Restore

The Restore option is used to restore your backed up data, in the event that the data is lost or if a system restore (recovery) has been performed.

This function is only applicable when a backup file has been previously saved (file extension .sna). See [Backup](#) on page 166 for additional information.



To perform a data Restore:

1. From the Home screen select **System Settings**.
2. From the System Settings main menu select **Data Backup > Restore**.
The restore file confirmation dialog box opens ([Figure 12-11](#)).
3. Select **Continue**.



Figure 12-11

The Windows restore backup file path dialog box opens.

4. Select the backup file (file extension .sna) from your backup file location.
5. Select **Open** to restore the backup file.

Once the file has been restored a confirmation message is displayed.

6. Select **OK**, then close and restart the Diagnostic application.

ShopStream Update Tool (SST)

The ShopStream Update Tool (SST) is a maintenance program that automatically keeps your diagnostic software up-to-date.

The following terms are used in this section and throughout this manual as described below:

- **Software Upgrade** - a new diagnostic software version. Software upgrades include new and enhanced coverage and features.
- **Software Update** - a service release “update” for a existing diagnostic software version

For clarity, throughout this document the term “software update(s)” will be used to collectively describe “software updates, upgrades and SST program updates” using the SST, except where noted.

The ShopStream Update Tool program downloads and installs:

- Diagnostic software upgrades
- Diagnostic software updates
- SST program updates

When connected to the Internet, the SST automatically checks for new software updates. This automatic check also occurs every time the diagnostic tool is turned on. If a software update is available, the SST will download it.

The SST is a low priority program that only downloads software updates when unused bandwidth is available. If other programs are running that communicate over the Wi-Fi network, such as a browser or instant messaging, the download may be temporarily suspended. This allows you to continue normal diagnostic tool operation, without interruptions or loss of performance.

13.1 Basic Operation

The SST program is normally running in the Windows background and available from the Windows taskbar notification area. The program can be accessed as follows:

- **SST icon in the notification area** - opens the SST program menu
- **SST program selection from the Windows “All Programs” or “Startup” menus** - starts the SST program and adds the SST icon to the notification area



NOTE:

If necessary, select the **expand**  arrow to see the SST icon in the notification area.

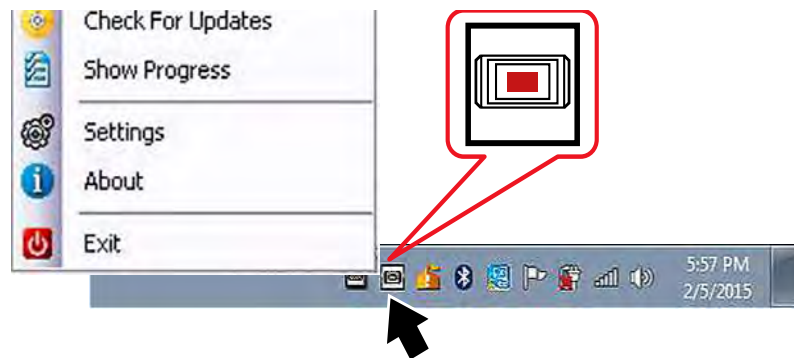

Figure 13-1 SST Icon in notification area

Selecting the SST icon from the notification area provides the following menu choices:

- **Check for Updates** - Allows you to manually check for software updates anytime. See [Manual Download](#) on page 171.
- **Show Progress** - allows you to check the status of an active download
- **Settings** - provides SST program options:
 - Turn on/off automatic software installation. **Applies only for SST program updates.** The default setting is “on” (box checked).
 - Set the hourly interval for the SST to check for software updates (choose number 2 to 168). **Applies to SST program updates, and diagnostic tool software upgrades/updates.** The default interval is 4 hours.



Figure 13-2

- **About** - displays the SST program software version number
- **Exit** - closes the SST program

13.2 End User License Agreement

Before software installation at initial purchase, and before all subsequent software updates/ upgrades installations End User License Agreement (EULA) acceptance is required.

IMPORTANT:

Use of Software is governed by the terms and conditions of the End User License Agreement. The diagnostic tool should not be initially operated until the End User License Agreement is read. Use of the device acknowledges your acceptance of the End User License Agreement. The Snap-on Incorporated Software End User License Agreement is available at: <https://eula.snapon.com/diagnostics>

To Accept: at the screen prompt (Figure 13-3) click the checkbox on the left side of the window, and then select **Agree and Continue**. The software will be installed automatically.

Figure 13-3 below represents a typical EULA acceptance agreement screen.

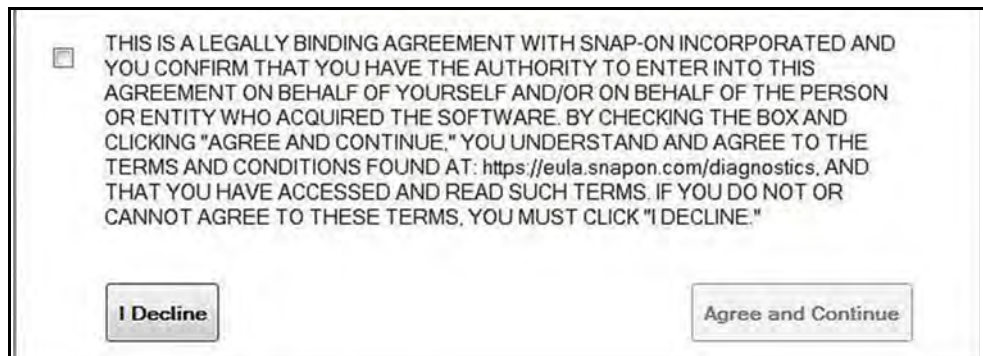

Figure 13-3 Typical EULA acceptance screen

To Decline: at the screen prompt (Figure 13-3) select **I Decline**. A confirmation message is displayed providing options to Go Back or Exit the software installation (Figure 13-4).

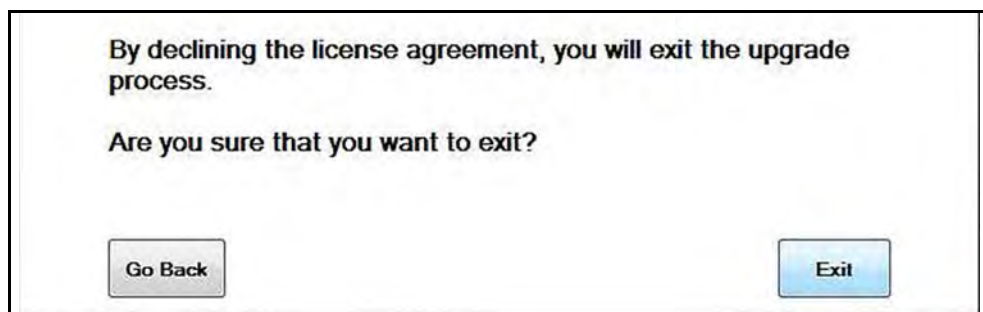

Figure 13-4 Typical EULA acceptance screen

13.3 Manual Download

This section describes the basic procedures for manually downloading software updates and upgrades.

Normally, the SST will automatically detect and download software. If necessary, use the following procedure to manually check for and download software.



NOTE:

It is recommend that you download software upgrades when not actively using the diagnostic tool. Download times will vary as they are dependent on the file size of the upgrade (some upgrades may exceed 3Gb) and your connection speed. It is suggested that you start the download at the end of your day and let it run overnight. For software upgrade installation instructions, see [Installing Software Upgrades](#) on page 174.



To manually download software:

1. Select the SST icon in the Windows taskbar notification area to open the menu ([Figure 13-5](#)).

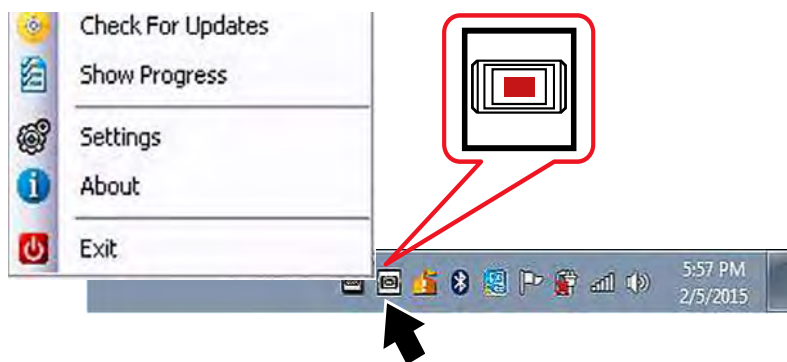

Figure 13-5 ShopStream Update Tool icon and menu

2. Select **Check for Updates** from the menu.
A series of message boxes will display as the SST searches for updates ([Figure 13-6](#)).



Figure 13-6 Typical - Checking for Updates message

Once the search is complete, one of two results are expected:

- If no updates are found, the message box closes and a “No updates available” message displays. Select the message to close it.
- If updates are found, they will automatically begin to download (Figure 13-7).

To view the update status window (Figure 13-7), select **Show Progress** from the SST icon menu (Figure 13-5).

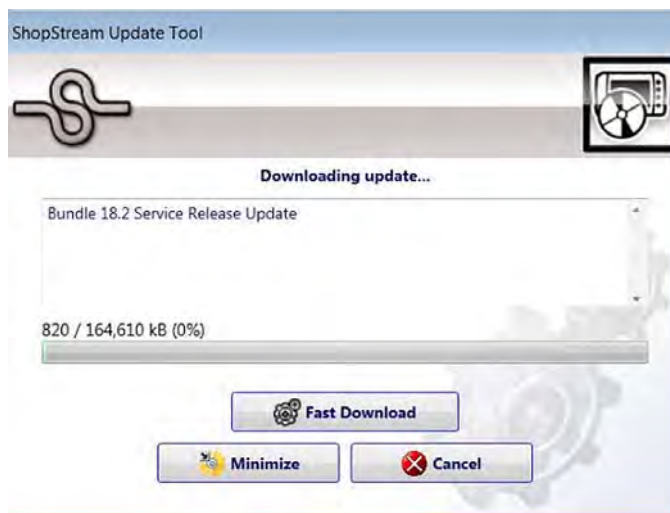

Figure 13-7 Typical - Update status window



NOTE:

The percentage status bar may not always be displayed while downloading (Figure 13-7).

3. During an active download, two options are available:
 - **Fast Download**—selecting Fast Download provides the option to either initiate a faster download, or continue downloading the background. If Fast Download is selected, it may adversely affect diagnostic tool performance, only choose if you are not actively using the Diagnostic Suite.
 - **Minimize**—closes the message box. The download continues as a background task and the diagnostic tool can be used normally. Select **Show Progress** from the SST icon menu at any time to reopen the message box and check the status of the download.
 - **Cancel**—stops and cancels the download and closes the message box. If you select Cancel, and choose to re-start the download again, the download will start from the beginning.
4. Once the download completes, it must be installed. See the applicable instructions for [Installing Software Updates](#) on page 173 or [Installing Software Upgrades](#) on page 174. For SST program updates (only) - if you have the Automatic Update setting “on”, the update will be installed automatically. See Automatic Update setting in [Basic Operation](#) on page 168 for additional information.

If you have the Automatic Update setting “off”, the SST program must be manually installed. See [Installing Software Updates](#) on page 173.

**NOTE:**

If the Internet connection is interrupted during a download, the download is suspended and a “network unavailable” message displays. The message disappears and the download resumes automatically once the Internet connection is restored.

13.4 Installing Software Updates

When a software update is ready for installation, an installation update message will appear (Figure 13-8). You can select the message or the SST icon from the Windows taskbar notification area at anytime to start the software update installation process.

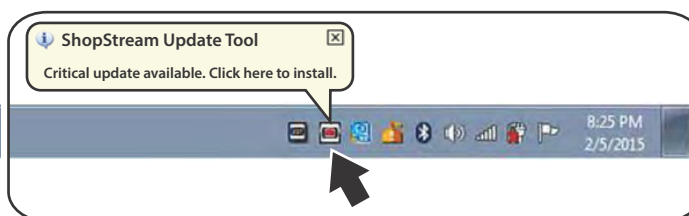

Figure 13-8 Typical update installation message

**NOTE:**

Before installing a software update, have your Scan Module and USB cable available. The software update may include Scan Module firmware updates that need to be installed.

**To install a software update:**

1. Select the software update available message (Figure 13-8), or the SST icon from the notification area.

A software update installation window will display (Figure 13-9).



Figure 13-9 Typical update installation window

2. Select an installation option to continue:

- **Install Now**—starts the software update installation. Proceed to step 3.
- **Install Later**—closes the message. The message will reappear at a later time as a reminder.

**NOTE:**

If **Install Later** is chosen, you can select the SST icon from the notification area to restart the installation at anytime.

3. Close the **ShopStream Diagnostic Suite** application. The ShopStream Diagnostic Suite should remain closed until the software installation has completed.
4. Follow the on-screen instructions to complete the installation.
5. After the installation is complete, open the **ShopStream Diagnostic Suite** application.
6. Select **Scanner** from the Home Screen. If a Scan Module firmware update has been received, a “Scan Module firmware update” message will display. Proceed to [Updating Scan Module Firmware](#) on page 74.
 - If the Scanner opens normally and no update message is displayed, proceed to step 7.
7. Turn the diagnostic tool off, then turn it on (re-boot).
8. From the toolbar, select **Menu > HELP > Version Info** to confirm the new version number is installed.

13.5 Installing Software Upgrades

**NOTE:**

It is recommended that you perform software upgrade installations Monday – Friday, during business hours to ensure customer care representatives are available for support. The installation will take approximately 30 minutes. If the installation is interrupted, Contact Snap-on Diagnostics Customer Care for assistance. See the Snap-on contact information at the front of this manual.

**NOTE:**

Before installing a software upgrade, have your Scan Module and USB cable available. The software upgrade may include firmware updates that need to be installed to the Scan Module.

**To install a software upgrade:**

1. Select the software upgrade available message ([Figure 13-10](#)), or the SST icon from the Windows taskbar notification area.



Figure 13-10 Typical upgrade installation message

An upgrade installation window will display (Figure 13-11).

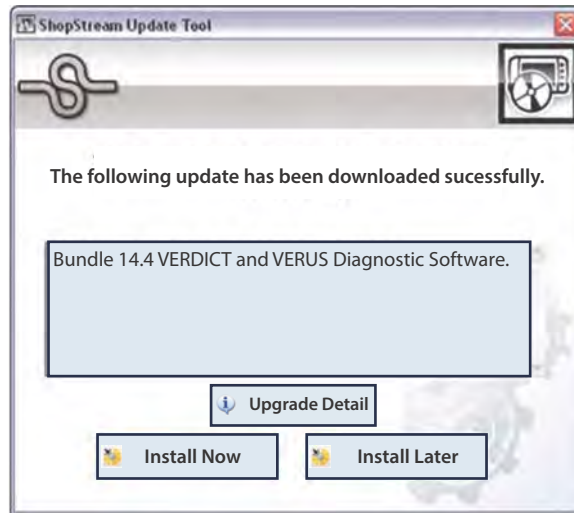

Figure 13-11 Typical upgrade installation window

2. Select an installation option to continue:
 - **Upgrade Detail**—opens a PDF file describing the details of the software upgrade, including any accessories that may be required.
 - **Install Now**—starts the software upgrade installation. Proceed to step 3.
 - **Install Later**—closes the upgrade message. The upgrade available message reappears at a later time as a reminder.



NOTE:

If **Install Later** is chosen, you can select the SST icon from the notification area to restart the installation at anytime.

3. Close the **ShopStream Diagnostic Suite** application. The ShopStream Diagnostic Suite should remain closed until the software installation has completed.
4. Follow the on-screen instructions to complete the installation.
5. After the installation is complete, open the **ShopStream Diagnostic Suite** application.
6. Select **Scanner** from the Home Screen, if a Scan Module firmware update has been received, a “Scan Module firmware update” message will display, proceed to [Updating Scan Module Firmware](#) on page 74.
 - If the Scanner opens normally and no update message is displayed, proceed to step 7.
7. Turn the diagnostic tool off, then turn it on (re-boot).
8. From the toolbar, select **Menu > HELP > Version Info** to confirm the new version number is installed.

This section describes typical maintenance and care procedures for your Diagnostic Tool and components.

14.1 Diagnostic Tool

14.1.1 Cleaning

Periodically perform the following tasks to keep your Diagnostic Tool in proper working order:

- Check the housing, cables and connectors for dirt and damage before and after each use.
- At the end of each work day, wipe the Diagnostic Tool housing, cables and connectors clean with a damp cloth.

IMPORTANT:

Do not use any abrasive cleansers or automotive chemicals on the Diagnostic Tool.

14.1.2 Cleaning the Touch Screen

The touch screen can be cleaned with a soft cloth and a mild window cleaner.

IMPORTANT:

Do not use any abrasive cleansers or automotive chemicals on the touch screen.

14.1.3 Battery Service

Follow all safety guidelines when handling the battery pack.

 **WARNING**

Risk of electric shock.

- **Prior to recycling the battery pack, protect exposed terminals with heavy insulating tape to prevent shorting.**
- **Disconnect all test leads and turn Diagnostic Tools off before removing the battery pack.**
- **Do not attempt to disassemble the battery or remove any component projecting from or protecting the battery terminals.**
- **Do not expose the Diagnostic Tool or battery pack to rain, snow, or wet conditions.**
- **Do not short circuit the battery terminals.**

Electric shock can cause injury.

 **WARNING**

Risk of explosion.

- **The Lithium battery is factory replaceable only, incorrect replacement or tampering with the battery pack may cause an explosion.**

Explosion can cause death or serious injury.

Battery Safety Guidelines

IMPORTANT:

The battery pack contains no user serviceable components. Tampering with the battery pack terminals or housing will void the product warranty.

Keep the following in mind when using and handling the battery pack:

- Do not short circuit battery pack terminals.
- Do not immerse the Diagnostic Tool or battery pack in water, or allow water to enter the Diagnostic Tool or battery pack.
- Do not crush, disassemble, or tamper with the battery pack.
- Do not heat the battery pack to over 100°C (212°F), or dispose of it in a fire.
- Do not expose the battery pack to excessive physical shock or vibration.
- Keep the battery pack out of reach of children.
- Do not use a battery pack that appears to have suffered abuse or damage.
- Charge the battery pack in the appropriate charger only.
- Do not use a battery charger that has been modified or damaged.
- Use the battery pack for the specified product only.
- Store the battery pack in a cool, dry, well ventilated area.

**NOTE:**

The battery pack should be used within a short period of time (about 30 days) after charging to prevent loss of capacity due to self-discharging.

If long-term storage of the battery pack is necessary, it should be stored in a in a cool, dry, well ventilated place with a 30 to 75 percent state of charge to prevent loss of characteristics.

To prolong the life of your battery, turn off the Diagnostic Tool when not in use. The Diagnostic Tool has a built in charger that recharges the battery on demand whenever it is connected to a power source.

Replacing the Battery Pack

If the battery pack no longer holds a charge, contact your sales representative to order a new one.

IMPORTANT:

Replace the battery pack with original Snap-on replacement parts only.

**To replace the battery pack:**

1. Loosen the two battery pack screws.
2. Carefully tilt the battery pack up from the bottom, and then remove it.

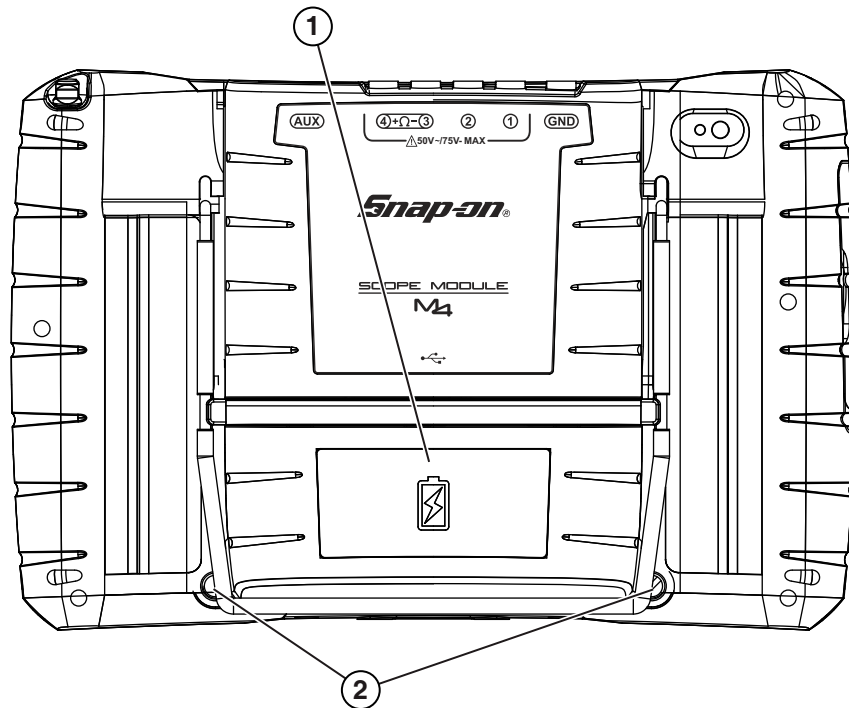

1— Battery Pack

2— Battery Pack Screws (2)

Figure 14-1 Battery pack location

3. In the opposite manner of removal; insert the new battery pack into position, then tilt it down into place making sure it is fully seated.

**NOTE:**

Do not overtighten the battery pack screws.

4. Tighten the two battery pack screws.

Disposing of the Battery Pack

Always dispose of a lithium-ion battery pack according to local regulations, which vary for different countries and regions. The battery pack, while non-hazardous waste, does contain recyclable materials. If shipping is required, ship the battery pack to a recycling facility in accordance with local, national, and international regulations. For additional information contact:

- **Australia**—Australia- Australian Battery Recycling Initiative at <http://www.batteryrecycling.org.au>
- **New Zealand**—Ministry for the Environment at <https://www.mfe.govt.nz/issues/waste/streams/batteries.html>

Products bearing the WEEE logo (Figure 14-2) are subject to European Union regulations.



Figure 14-2 sample WEEE logo



NOTE:

Always dispose of materials according to local regulations.

Contact your sales representative for details.

14.1.4 Calibrating the Touch Screen

The touch screen can be calibrated for accuracy using the Windows Tablet PC Settings.



To calibrate the touch screen:

1. From the Windows menu select **Start > Control Panel > Hardware and Sound > Tablet PC Settings**.

The Tablet PC Setting window is displayed (Figure 14-3).

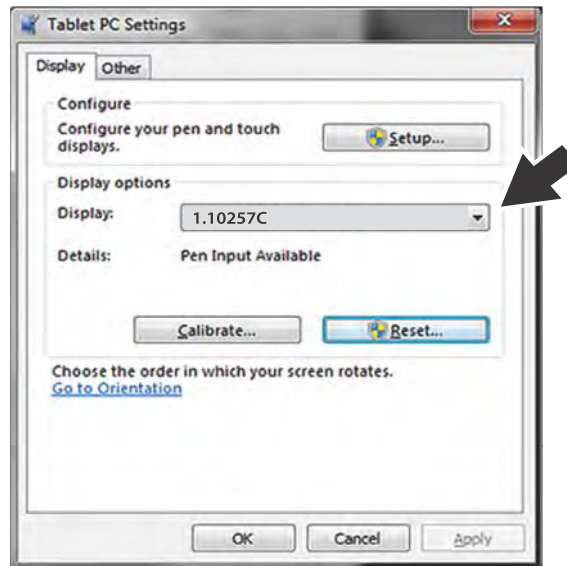

Figure 14-3 Typical - Tablet PC Settings window

2. Select the diagnostic tool display from the dropdown list. The current default diagnostic tool display number “1.10257C” is shown in (Figure 14-3), as an example.



NOTE:

If you are using an optional touch screen (e.g. using an external touch screen with a Tech Cart and docking station), there will be an additional touch screen choice displayed.

3. Select **Calibrate**.

The Calibration screen is displayed (Figure 14-4).

4. Using the stylus, follow the screen prompts and tap on the center of the cross-hairs as they appear at each corner on the screen (Figure 14-4).



NOTE:

To achieve the best results, it is recommended to use the capacitive stylus when performing the touch screen calibration.

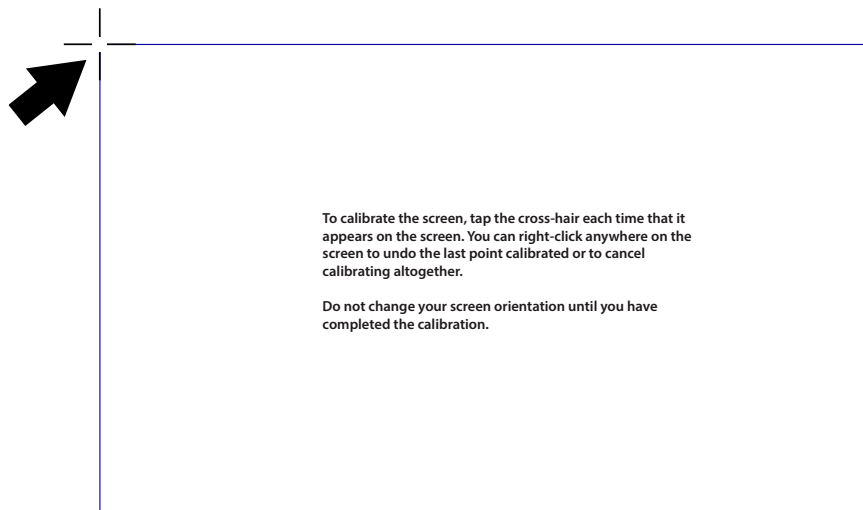

Figure 14-4 Calibrating the Touch Screen

5. Select **OK** to close the dialog boxes once the calibration is complete.

14.1.5 Screen Protector Installation

Touch screen protectors are available as optional equipment (contact your sales representative to order). The following procedure describes typical installation procedures.

Items recommended for installation:

- Microfiber type cloth (lint-free)
- Flexible straight edged tool (e.g. small squeegee, plastic card)
- Cellophane tape



To install a screen protector:



NOTE:

Cleanliness is the most important factor during the installation of the screen protector. The following tips are provided to assist in the installation:

Clean your hands thoroughly.

Clean the touch screen thoroughly using a microfiber type cloth, removing all dirt, dust, grease, fingerprints etc. See [Cleaning the Touch Screen](#) on page 176 for additional information.

Work in a well lit area.

Minimize dust; work in an area with minimal air movement, turn off fans or air conditioning etc.

1. Thoroughly clean and dry the touch screen. See [Cleaning](#) on page 176 for additional information.

2. Remove the rear mask (Figure 14-5) from the screen protector.

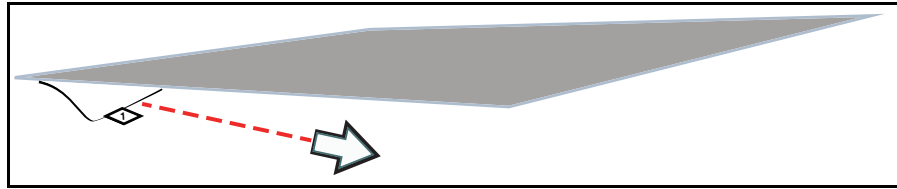

Figure 14-5 Removing rear mask

3. Carefully align the edge of the protector with the edge of the screen, and slowly allow the screen protector to lie flat on the screen (Figure 14-6).

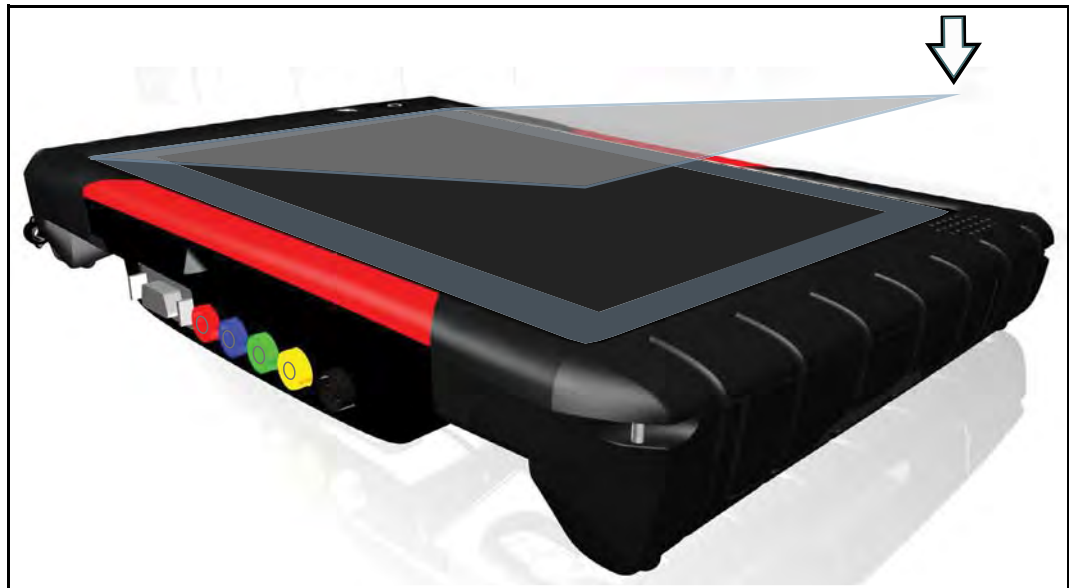

Figure 14-6

4. Once the protector is in place, use a microfiber cloth to work out any air bubbles.



NOTE:

To remove air bubbles, slowly work from the inside towards the edges. If large air bubbles are trapped, it may be easier to carefully peel back the protector and re-apply.

If air bubbles are persistent, it is an indication that the screen and/or protector are not clean.

If visible dust is trapped under the protector, peel back the protector and use the adhesive side of a small piece of cellophane tape to remove the dust.

14.1.6 Stylus Tip Replacement

Periodically the capacitive stylus tip may need to be replaced. There are two styles of removable stylus tips.

Style "A" (Figure 14-7) - To remove, unthread the tip counterclockwise. To install a new stylus tip, thread it on clockwise until seated.

Style "B" (Figure 14-8) - To remove, unthread the collar counterclockwise. To install a new stylus tip, remove the old tip from the shaft and install a new tip, then thread the collar on clockwise until seated.

Stylus tips are available as optional equipment (contact your sales representative to order).

IMPORTANT:

Do not overtighten the stylus tip.

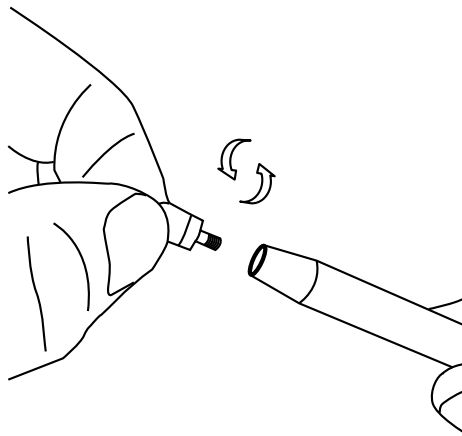

Figure 14-7 Replacing stylus tip - (Style A)

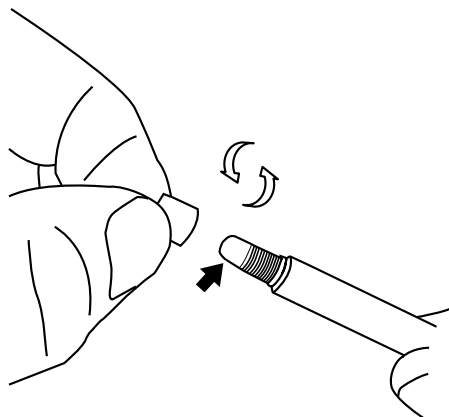

Figure 14-8 Replacing stylus tip - (Style B)

14.1.7 Operating System Restore

Snap-on System Restore is a hard disk drive recovery program that allows you recover the hard disk drive files in the event of a failure. Running the program replaces all of the C drive data with the original factory data. Be aware, all new or modified files on the C drive will be lost.



To restore the operating system

1. Turn on the Diagnostic Tool.
2. Wait for the “Press the “S” button to run Snap-on System Restore.” message to display, then Press the **Shortcut (S)** button.

A progress indicator displays while the program loads.

3. Select **OK** from the confirmation message.

A progress indicator displays while the files are being restored.

4. Select **OK** from the confirmation message.

The Diagnostic Tool shuts down, then reboots and the system recovery portion of the operation begins. Follow any on-screen prompts.

The Diagnostic Tool shuts down and reboots a second time. When the Home screen displays, the procedure is complete and the Diagnostic Tool is ready for use.

14.2 Scan Module

This section covers how to care for your Scan Module.

14.2.1 Cleaning and Inspecting the Scan Module

When using the Scan Module, make sure to do the following:

- Check the housing, wiring, and connectors for dirt and damage before and after each use.
- At the end of each work day, wipe the housing, wiring, and connectors clean with a slightly damp cloth.

IMPORTANT:

Do not use any abrasive cleansers or automotive chemicals on the Scan Module.

14.2.2 Replacing the Protective Handgrip

The soft protective handgrip that covers the outer edges of the Scan Module is easily replaced should it become worn or damaged. Contact your sales representative for replacement parts.



To replace the protective handgrip:

1. Disconnect the data cable, and any other cables, if attached to the Scan Module.
2. From the bottom of the Scan Module, gently lift up and out on one side of the handgrip to free it from Scanner housing.
3. Repeat step 2 to loosen the other side of the handgrip.
4. Lift the handgrip off of the Scan Module housing.

**NOTE:**

The handgrip tapers toward the front of the Scan Module housing. Make sure the replacement handgrip is correctly oriented before attempting to install it.

5. Fit the new handgrip over the top, data cable end, of the Scan Module housing.
6. With your fingers, work the new handgrip onto the Scan Module housing from top to bottom. Make sure the tabs on the handgrip fit into the grooves on the housing.