

# **SOLUS<sup>TM</sup>**

## **User Manual**

**August 2009**

**EAZ0007E76F Rev. A**

---

## **Trademarks**

SOLUS and Scanner are trademarks of Snap-on Incorporated.

All other marks are trademarks or registered trademarks of their respective holders.

## **Copyright Information**

©2009 Snap-on Incorporated. All rights reserved.

## **Disclaimer**

The information, specifications and illustrations in this manual are based on the latest information available at the time of printing.

Snap-on reserves the right to make changes at any time without notice.

## **Visit our website at:**

[www.snapon.com/solus](http://www.snapon.com/solus) (North America)

[snapondiag.com](http://snapondiag.com) (Europe)

[sun-diagnostics.com](http://sun-diagnostics.com) (Europe)

## **For Technical Assistance**

CALL 1-800-424-7226 (North America)

CALL +44 (0) 845 601 4736 (United Kingdom)

E-mail [DiagnosicsUKproductsupport@snapon.com](mailto:DiagnosicsUKproductsupport@snapon.com) (United Kingdom)

For technical assistance in all other markets, contact your selling agent.

---

# Safety Information

For your own safety and the safety of others, and to prevent damage to the equipment and vehicles upon which it is used, it is important that the accompanying *Safety Information* be read and understood by all persons operating, or coming into contact with, the equipment. We suggest you store a copy near the unit in sight of the operator.

This product is intended for use by properly trained and skilled professional automotive technicians. The safety messages presented throughout this manual are reminders to the operator to exercise extreme care when using this test instrument.

There are many variations in procedures, techniques, tools, and parts for servicing vehicles, as well as in the skill of the individual doing the work. Because of the vast number of test applications and variations in the products that can be tested with this instrument, we cannot possibly anticipate or provide advice or safety messages to cover every situation. It is the automotive technician's responsibility to be knowledgeable of the system being tested. It is essential to use proper service methods and test procedures. It is important to perform tests in an appropriate and acceptable manner that does not endanger your safety, the safety of others in the work area, the equipment being used, or the vehicle being tested.

It is assumed that the operator has a thorough understanding of vehicle systems before using this product. Understanding of these system principles and operating theories is necessary for competent, safe and accurate use of this instrument.

Before using the equipment, always refer to and follow the safety messages and applicable test procedures provided by the manufacturer of the vehicle or equipment being tested. Use the equipment only as described in this manual.

Read, understand and follow all safety messages and instructions in this manual, the accompanying safety manual, and on the test equipment.

## Safety Message Conventions

Safety messages are provided to help prevent personal injury and equipment damage. All safety messages are introduced by a signal word indicating the hazard level.

### **DANGER**

Indicates an imminently hazardous situation which, if not avoided, will result in death or serious injury to the operator or to bystanders.

### **WARNING**

Indicates a potentially hazardous situation which, if not avoided, could result in death or serious injury to the operator or to bystanders.

### **CAUTION**

Indicates a potentially hazardous situation which, if not avoided, may result in moderate or minor injury to the operator or to bystanders.

Safety messages contain three different type styles.

- Normal type states the hazard.
- Bold type states how to avoid the hazard.
- Italic type states the possible consequences of not avoiding the hazard.

An icon, when present, gives a graphical description of the potential hazard.

Example:



Risk of unexpected vehicle movement.

- **Block drive wheels before performing a test with engine running.**  
*A moving vehicle can cause injury.*

## Important Safety Instructions

For a complete list of safety messages, refer to the accompanying safety information.

**SAVE THESE INSTRUCTIONS**

# Table of Contents

<b>Safety Information</b> .....	<b>iii</b>
<b>Table of Contents</b> .....	<b>v</b>
<b>Chapter 1: Using This Manual</b> .....	<b>1</b>
Conventions.....	1
Bold Text.....	1
Symbols .....	1
Terminology .....	2
Notes and Important Messages .....	2
Procedures.....	2
Additional Manuals .....	3
Tool Help .....	3
<b>Chapter 2: Introduction</b> .....	<b>4</b>
Functional Description .....	4
Technical Specifications .....	6
The Stand .....	7
Control Buttons.....	8
N/X Button.....	8
Y/✓ Button.....	8
Thumb Pad .....	9
Brightness/Contrast Button .....	9
S Button .....	9
Power Button .....	9
Connections.....	9
DC Power Input.....	9
USB Port .....	9
IR Output.....	10
Data Cable Connector .....	10
Power Supply .....	10
Vehicle Power .....	10
Battery Power .....	10
AC/DC Power Supply.....	11
Cables .....	11
Data Cable .....	11
Auxiliary Power Cables .....	12
<b>Chapter 3: Getting Started</b> .....	<b>13</b>
Supplying Power.....	13
Demonstration Mode .....	13
Connecting to Vehicle Power .....	14
Installing the Batteries .....	14
Connecting an AC/DC Power Supply .....	16
Powering On the Unit .....	16

Setting Up to Print .....	16
Connecting to a Computer.....	17
Powering Off the Unit .....	17
Adjusting Brightness and Contrast .....	18
<b>Chapter 4: Navigation .....</b>	<b>19</b>
Screen Layout .....	19
Upper Toolbar .....	20
Buffer Bar .....	21
Main Body .....	22
LED Indicators .....	22
Making Selections .....	22
Using Easy Scroll .....	22
Screen Messages.....	23
Confirmation Messages .....	23
Warning Messages .....	23
Error Messages.....	23
<b>Chapter 5: Operations.....</b>	<b>24</b>
Selecting the Manufacturer.....	25
Identifying the Vehicle .....	25
Selecting a System.....	26
Connecting to a Vehicle.....	26
Selecting from the System Main Menu.....	27
Using the Scanner Functions .....	27
Data Display.....	27
Codes Menu.....	28
Functional Tests.....	30
Troubleshooter .....	30
Terminating Vehicle Communication.....	31
Exiting Scanner Mode.....	32
Viewing Data Graphically .....	32
Changing Screen Views.....	33
Pausing Data .....	41
Clearing the Data Buffer .....	42
Sorting the Data .....	42
Using Cursors .....	42
Using Zoom.....	43
Saving Captured Data .....	44
Viewing Saved Data .....	46
Identifying Saved Files .....	47
Loading Saved Files .....	48
Editing Saved Files .....	48
Reviewing Saved Data.....	48
Deleting Saved Files .....	49
Copying and Moving Saved Data .....	49
Selecting All Files.....	50
Viewing Saved Data Information.....	50
Setting a Destination for Saved Data.....	50
Printing .....	51

Tools Button .....	51
Custom Setup .....	52
Save Data .....	53
Custom Data List .....	53
LED Setup.....	54
Utilities .....	54
Tool Setup.....	54
System Tools .....	61
Tool Help.....	61
Easy Scroll .....	62
Connect to PC.....	62
Run .....	62
System Info .....	62
<b>Chapter 6: Maintenance .....</b>	<b>64</b>
Cleaning and Damage Inspection .....	64
Replacing the Batteries .....	64
Storage Tips .....	65
Disposing of the Batteries.....	65
<b>Appendix A: Frequently Asked Questions.....</b>	<b>66</b>
When I first turn on the scan tool, why does it beep but nothing appears on-screen? .....	66
Can I use my other Snap-on® test adapters with this scan tool? .....	66
Why do my batteries drain so quickly? .....	66
What should I do if my printer is not responding? .....	67
What should I do if the unit doesn't respond as expected when I press the Power button? .....	67
Why does my unit shut down unexpectedly? .....	67
<b>Appendix B: Troubleshooting .....</b>	<b>68</b>
No Communication Message .....	68
Unit Will Not Power On.....	68
Emergency Restart.....	69
<b>Appendix C: Downloading and Installing Software Updates .....</b>	<b>70</b>
Check for Service Upgrades Before Use.....	70
Verifying Minimum PC Requirements.....	70
Verifying PC System Properties.....	71
Downloading and Installing ShopStream Connect .....	72
Downloading Service Upgrades .....	74
Before You Begin .....	74
Installing a Service Upgrade .....	74
<b>Index .....</b>	<b>77</b>

This manual contains tool usage instructions.

Some of the illustrations shown in this manual may contain modules and optional equipment that are not included on your system. Contact your sales representative for availability of other modules and optional equipment.

## 1.1 Conventions

The following conventions are used.

### 1.1.1 Bold Text

Bold emphasis is used in procedures to highlight selectable items such as buttons and menu options.

Example:

- Press the **Y/✓** button.

### 1.1.2 Symbols

Different types of arrows are used.

The “greater than” arrow (>) indicates an abbreviated set of selection instructions.

Example:

- Select **Utilities > Tool Setup > Date**.

The example statement abbreviates the following procedure:

1. Navigate to the **Utilities** button.
2. Use the Thumb Pad to navigate to and highlight the **Tool Setup** submenu.
3. Use the Thumb Pad to navigate to and highlight the **Date** option from the submenu.
4. Press **Y/✓** to confirm the selection.

The solid arrows (◀, ▶, ▼, ▲) are navigational instructions referring to the four directions of the Thumb Pad.

Example:

- Press the down ▼ arrow.



### 1.1.3 Terminology

The term “select” means highlighting a button or menu item using the Thumb Pad and pressing the **Y/✓** button to confirm the selection.

Example:

- Select **Reset**.

The above statement abbreviates the following procedure:

1. Navigate to and highlight the **Reset** button.
2. Press the **Y/✓** button.

### 1.1.4 Notes and Important Messages

The following messages are used.

#### Notes

A NOTE provides helpful information such as additional explanations, tips, and comments.

Example:

**NOTE:**

For additional information refer to...

---

#### Important

IMPORTANT indicates a situation which, if not avoided, may result in damage to the test equipment or vehicle.

Example:

---

**IMPORTANT:**

Do not force the CompactFlash<sup>®</sup> card into the slot.

---

### 1.1.5 Procedures

An arrow icon indicates a procedure.

Example:

**To change screen views:**

1. Select the **View** button.  
The drop-down menu displays.
2. Select an option from the menu.  
The screen layout changes to the format you selected.

## 1.2 Additional Manuals

This tool works in conjunction with other software products, which have their own manuals. See the appropriate manual for information regarding these products.

## 1.3 Tool Help

Tool Help, which contains reference and procedural information found in this manual, is available on the scan tool. See “Tool Help” on page 61 for details.

The SOLUS™ scan tool uses Vehicle Communication Software and Fast Track® Troubleshooter software to provide vehicle-specific trouble codes for various vehicle control systems such as engine, transmission, antilock brake system (ABS) and more, selected functional tests, and troubleshooting information. The scan tool can also graph live data parameters on-screen.

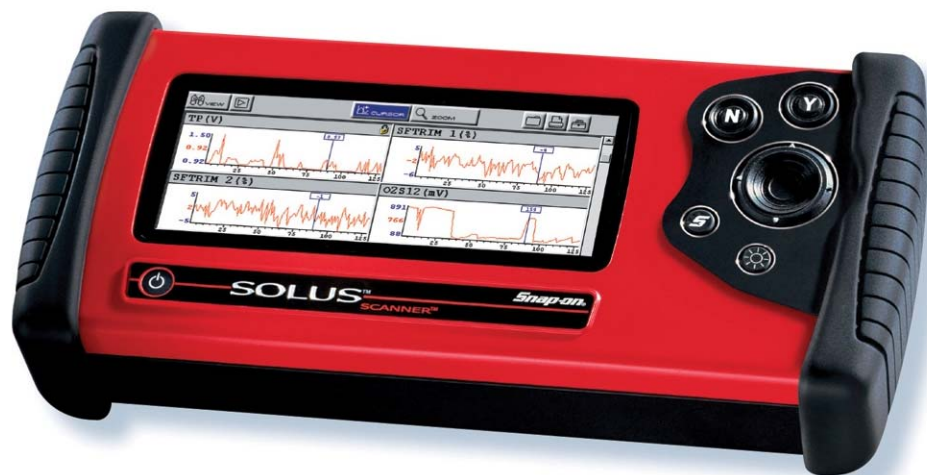
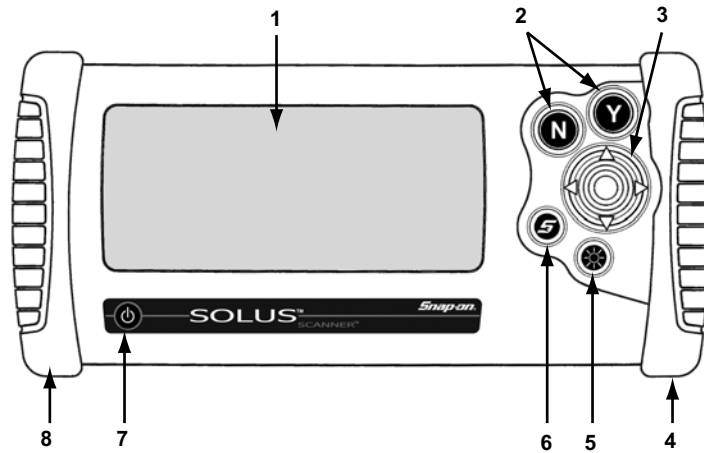


Figure 2-1 SOLUS™

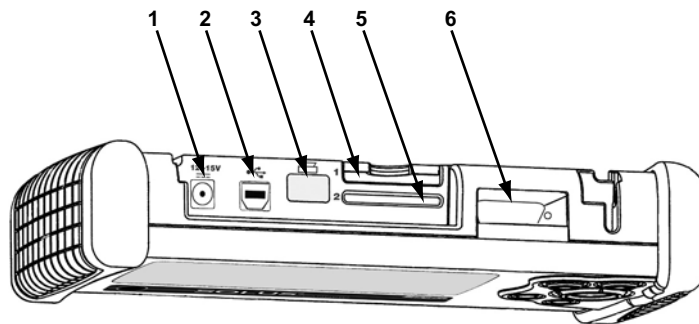
## 2.1 Functional Description

Figure 2-2, Figure 2-3, and Figure 2-4 show the external features of the scan tool.



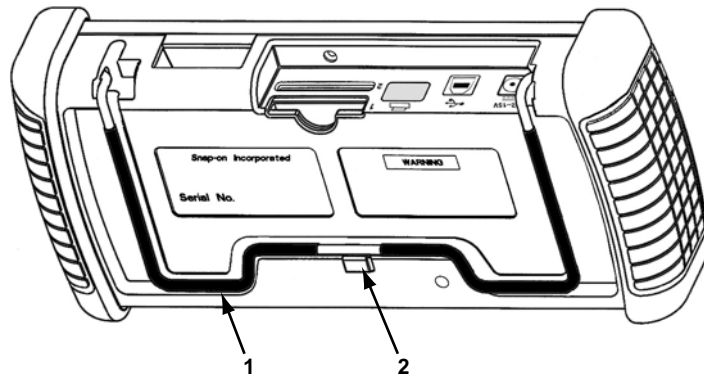
- 1— Liquid Crystal Display (LCD)
- 2— N/X (No) and Y/✓ (Yes) buttons
- 3— Thumb Pad
- 4— Right handgrip
- 5— Brightness/Contrast button
- 6— S button
- 7— Power button
- 8— Left handgrip

**Figure 2-2** *Front view*



- 1— DC power supply input
- 2— USB port
- 3— Infrared (IR) output
- 4— CompactFlash® (CF) Card Slot 1
- 5— CF Card Slot 2
- 6— Data cable connector

**Figure 2-3** *Top view*



- 1— Stand  
2— Casing hook

Figure 2-4 Back view

## 2.2 Technical Specifications

### Display:

Liquid Crystal Display (LCD)  
640 x 240 resolution  
256 colors  
6.2 inches (157.5 mm)

### CompactFlash® Card Slot:

Slot 1 is for the system CF card  
Slot 2 is for the data storage CF card

---

### IMPORTANT:

Never remove the master storage CF card while the unit is turned on. Doing so will damage the software and prevent your scan tool from operating properly.

---

### Dimensions:

#### Width:

11.7 inches  
296.4 mm

#### Height:

5.4 inches  
136.9 mm

#### Depth:

2.3 inches  
57.4 mm

**Weight:**

2.5 lbs

1,134 g

**Operating Temperature Range:**

14 to 104°F

-10 to 40°C

**Storage Temperature Range:**

-4 to 149°F

-20 to 65°C

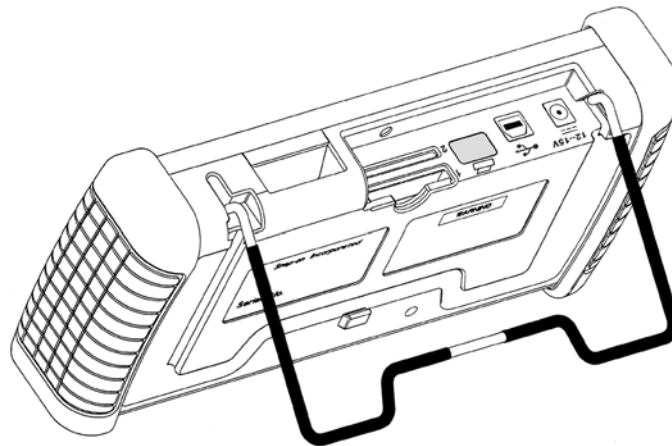
**Batteries:**

(6) 1.5V AA

## 2.3 The Stand

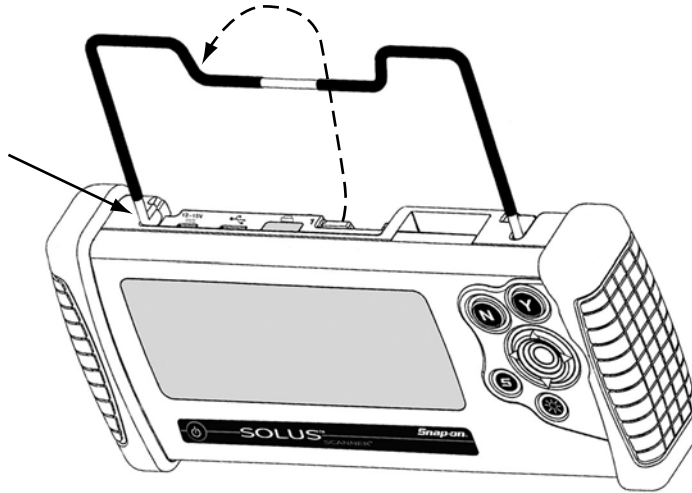
The scan tool has a built-in, metal stand attached to the back. When the stand is not in use, it is secured to the back of the unit by an integrated casing hook (Figure 2-4 on page 6).

When extended, the stand allows the unit to rest at a 45° angle for hands-free viewing (Figure 2-5).



**Figure 2-5** *Stand extended*

The stand can also be extended to a hanging position by pressing the left side towards the right and rotating forward (Figure 2-6).



**Figure 2-6** *Stand in hanging position*

## 2.4 Control Buttons

This scan tool has the following control buttons (Figure 2-2 on page 5):

- No (**N/X**) button
- Yes (**Y/✓**) button
- Thumb Pad
- Brightness/Contrast button
- S button
- Power button

### 2.4.1 N/X Button

The **N/X** button is used to do the following:

- To exit a menu or program.
- To close an open list and return to the previous menu.
- To answer “No” when a Yes or No choice is given.
- To return to the main menu.

### 2.4.2 Y/✓ Button

The **Y/✓** button is used to do the following:

- To select the item you highlighted using the Thumb Pad.
- To answer “Yes” when a Yes or No choice is given.

### 2.4.3 Thumb Pad

The **Thumb Pad** moves the highlight, allowing vertical and horizontal on-screen movement. The Thumb Pad is typically used in combination with the **Y/✓** and **N/X** buttons.

### 2.4.4 Brightness/Contrast Button

The **Brightness/Contrast** button opens the dialog box that allows you to adjust the screen for optimum viewing. See “Adjusting Brightness and Contrast” on page 18 for details.

### 2.4.5 S Button

The **S** button can be customized to perform different functions from the **Utilities > Tool Setup** menu. See “S Button” on page 59 for details.

### 2.4.6 Power Button

The **Power** button powers on and powers off this scan tool. See “Powering On the Unit” on page 16 and “Powering Off the Unit” on page 17 for details.

## 2.5 Connections

This scan tool uses the following connections (Figure 2-3 on page 5):

- DC power adapter input
- USB port
- IR output
- Data cable connector

### 2.5.1 DC Power Input

The AC/DC power supply provides power to the scan tool through the DC power input on top of the unit (Figure 2-3 on page 5). For related information, see the following sections:

- “AC/DC Power Supply” on page 11
- “Connecting an AC/DC Power Supply” on page 16

### 2.5.2 USB Port

This scan tool has a USB port for connecting to a PC.



### 2.5.3 IR Output

The IR output is for printing data.

For related information, see the following sections:

- “Setting Up to Print” on page 16
- “Printing” on page 51

### 2.5.4 Data Cable Connector

The connector on the data cable fits to adapters that connect the scan tool to a vehicle for testing.

For related information, see the following sections:

- “Cables” on page 11
- “Connecting to Vehicle Power” on page 14

## 2.6 Power Supply

This scan tool can receive power from three sources:

- Vehicle power
- Battery power
- AC/DC power supply

For related information, see “Supplying Power” on page 13.

### 2.6.1 Vehicle Power

This scan tool can receive 12V vehicle power via the data cable either by itself or in conjunction with the auxiliary power cables included with this scan tool.

For related information, see the following sections:

- “Data Cable Connector” on page 10
- “Cables” on page 11
- “Connecting to Vehicle Power” on page 14

### 2.6.2 Battery Power

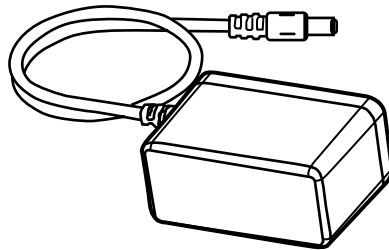
This scan tool can receive power from six internal AA batteries, which maintain the time, date, and other custom settings but *should not* be the primary source of power. Vehicle power should be the primary source of power during testing.

For related information, see the following sections:

- “Installing the Batteries” on page 14
- “Power Management” on page 55
- “Replacing the Batteries” on page 64

### 2.6.3 AC/DC Power Supply

This scan tool can be powered from a wall socket using the optional AC/DC power supply (Figure 2-7).



**Figure 2-7** AC/DC power supply

For related information, see the following sections:

- “DC Power Input” on page 9
- “Connecting an AC/DC Power Supply” on page 16

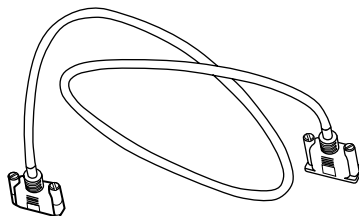
## 2.7 Cables

This scan tool uses the following cables:

- Data cable
- Power cables (cigarette lighter and battery)

### 2.7.1 Data Cable

The data cable (Figure 2-8) is included with your scan tool and uses interchangeable test adapters for connecting to vehicle diagnostic connectors. Captive screws secure both data cable ends.

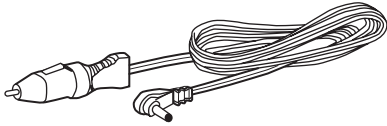


**Figure 2-8** Data Cable

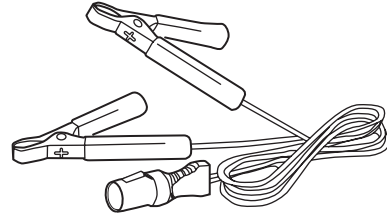
An optional data cable extension is available. Refer to the Accessory Guide, included with your kit, for a complete listing of accessories and replacement parts.

## 2.7.2 Auxiliary Power Cables

Two auxiliary power cables, the Lighter Power Cable (Figure 2-9) and the Battery Power Cable (Figure 2-10), are included with your scan tool and used for vehicles without battery power on the diagnostic connector.



**Figure 2-9** *Lighter power cable*



**Figure 2-10** *Battery power cable*

The following steps get you started using the scan tool:

1. Familiarize yourself with SOLUS controls and connections. Refer to “Control Buttons” on page 8 for details
2. Supply power to the scan tool
3. Press the **Power** button to turn the scan tool on

## 3.1 Supplying Power

There are three ways to supply power to the scan tool:

- Connect to vehicle power
- Install batteries
- Connect to an AC adapter

For related information, see “Power Supply” on page 10.



### NOTE:

To conserve batteries, we recommend always powering the unit from vehicle power or from the AC adapter. The internal batteries are not intended to be used as the primary power source. The batteries are intended to maintain the time, date, and custom settings. They also power the unit during the vehicle identification process.

---

## 3.2 Demonstration Mode

The scan tool contains programs to demonstrate scan tool test capabilities without actually connecting to a vehicle. A sample vehicle with mock test results is provided to help you become familiar with menus, navigation, and basic operations.



### To use the demonstration:

1. Connect the plug end of an AC/DC power supply to a wall socket and connect the jack end to the DC Power Supply Input port on the tool
2. Press the **Power** button to turn the scan tool on.
3. From the Scanner menu, select **EOBD**.
4. Press **Y/✓** to open the Database.
5. Highlight **OBD Training Mode** on the menu and Press **Y/✓** to select.  
The Main Menu OBD displays.
6. Highlight Start Communication and press **Y/✓** to select.
7. Press **Y/✓** to continue when the connection message displays.  
When data displays, navigate through the data as if you were connected to a vehicle.

8. To exit the demonstration, press **N/X** to return to the Main Menu OBD.
9. Highlight **End of Diagnose** and press **Y/✓**
10. To return to the Main Menu, highlight the **View** button on the upper toolbar and press **N/X**.

### 3.3 Connecting to Vehicle Power

You need the following to connect the scan tool unit to vehicle power:

- Data cable
- Test adapter
- Auxiliary power cables (see below)

For related information, see the following sections:

- “Data Cable Connector” on page 10
- “Vehicle Power” on page 10
- “Connecting to a Vehicle” on page 26



#### To connect to vehicle power:

1. Connect one end of the data cable to the data cable connector on top of the scan tool.
2. Connect the other end of the data cable to the appropriate test adapter. The scan tool displays relevant adapter and key usage for the identified vehicle.
3. Connect the test adapter to the vehicle diagnostic connector. The scan tool displays the location of the diagnostic connector.
4. Turn the ignition on.

For vehicles that do not supply power through the diagnostic connector, you must use the optional auxiliary power cables (see “Auxiliary Power Cables” on page 12).



---

#### NOTE:

Do not plug the Lighter Power Cable into the DC power input port on the top of the unit. Vehicle power must be supplied to the test adapter for the scan tool to communicate with the vehicle.

---



#### To use auxiliary power cables:

1. Connect the required test adapter to the data cable.
2. Plug the small end of the Lighter Power Cable into the port on the test adapter.
3. Plug the large end of the Lighter Power Cable into the socket of the Battery Power Cable.
4. Connect the clamps of the Battery Power Cable to the vehicle battery. Be sure to observe correct polarity when connecting to the vehicle battery.

### 3.4 Installing the Batteries

The scan tool comes with six alkaline AA batteries.

For related information, see the following sections:

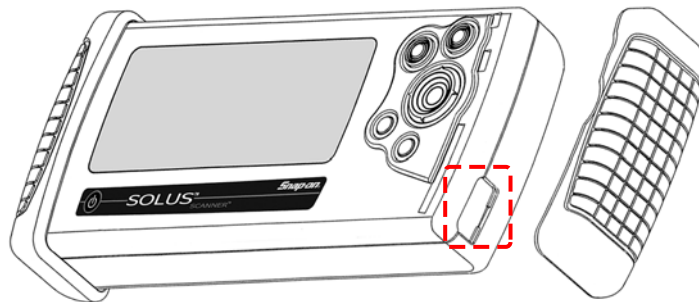
- “Battery Power” on page 10
- “Power Management” on page 55
- “Replacing the Batteries” on page 64

**IMPORTANT:**

Your scan tool will be damaged if the battery polarity is incorrect. Refer to the diagram on the rear cover of the scan tool for correct battery polarity.

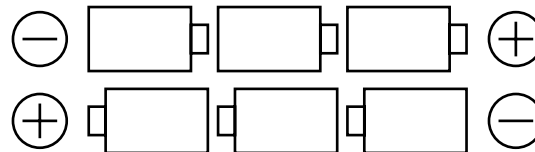
**To install the batteries:**

1. Remove the right handgrip.  
The battery slot is exposed (Figure 3-1).



**Figure 3-1** Battery slot

2. Unscrew the battery cover with a flathead screwdriver and remove the cover.
3. Observing proper polarity (shown on the back of the scan tool, Figure 3-2), install six AA batteries.



**Figure 3-2** Battery illustration diagram on back of the tool

4. Replace the cover and tighten the screw.
5. Replace the right handgrip.

**Note the following safety warnings when installing batteries.**

**⚠ WARNING**



Risk of expelling battery acid.



- **Do not let any material leaked from a battery come in contact with eyes or skin.**
- **Always make sure the battery polarities (“+” and “-”) are correct when installing.**
- **Have plenty of fresh water and soap nearby. If battery acid contacts skin, clothing, or eyes, flush exposed area with soap and water for 10 minutes.**

*Any battery may leak harmful chemicals which may damage eyes, skin, and clothing.*

Risk of personal injury or harm.

- **Do not expose batteries to excessive heat.**

- Use batteries from a reputable manufacturer only.
- When replacing batteries, always replace the whole set.
- Do not use different brands of batteries together.
- Do not try to recharge batteries that are not specifically designed to be recharged.
- Do not allow children to install batteries unsupervised.
- Follow the battery manufacturer's instructions as to proper handling, storage, and disposal of batteries.

*Improper use of batteries can result in personal harm.*

## 3.5 Connecting an AC/DC Power Supply

The optional AC/DC power supply provides power from a wall socket.

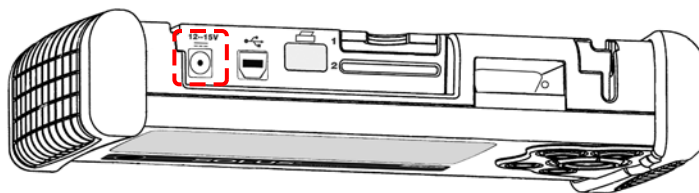
For related information, see the following sections:

- “DC Power Input” on page 9
- “AC/DC Power Supply” on page 11



**To connect an AC/DC power supply:**

1. Plug the 2.5 mm end of the AC/DC power supply cord into the DC power adapter input on the top of your scan tool (Figure 3-3).



**Figure 3-3** DC power supply input

2. Plug the other end of the power adapter into an appropriate wall socket.

## 3.6 Powering On the Unit

When a master storage CF card is installed and power is supplied, power on your scan tool.



**To power on the scan tool:**

- Press the **Power** button (Figure 2-2 on page 5).  
The unit beeps and the main menu screen displays after a few seconds.

## 3.7 Setting Up to Print

This scan tool prints wirelessly from infrared (IR) enabled, PCL 3 printers.

Before you can use the PRINT button in the upper toolbar, you must do the following:

1. Set up the printer.
2. Configure the scan tool to print.



**To set up the printer:**

- Refer to your printer's documentation for powering and paper loading instructions.



**To configure the scan tool to print:**

- Select a printer manufacturer and port from the **UTILITIES > Tool Setup > Printer** dialog box. See "Printer" on page 57 for details.

## 3.8 Connecting to a Computer

Connecting your scan tool to a computer for file sharing requires the use of the optional ShopStream Connect™ software. ShopStream Connect is a free software program that can be downloaded from the Internet at [software.snapon.com](http://software.snapon.com).

## 3.9 Powering Off the Unit

Use the **Power** button (Figure 2-2 on page 5) to turn the scan tool off.

---

**IMPORTANT:**

Do not use the **Power** options while using the Scanner software.

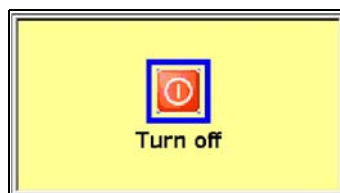
---



**To use the power options:**

1. Terminate vehicle communication, see "Terminating Vehicle Communication" on page 31.
2. Exit Scanner mode, see "Exiting Scanner Mode" on page 32.
3. Press the **Power** button.

The Turn off dialog box displays (Figure 3-4).



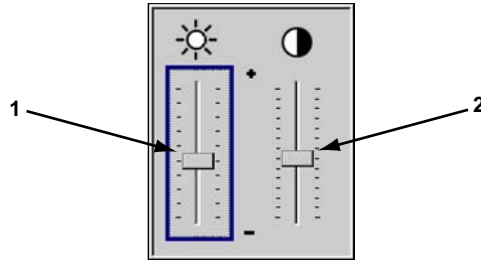
**Figure 3-4** Turn off dialog box

4. Select **Turn off**, or press **N/X** to cancel.



## 3.10 Adjusting Brightness and Contrast

The **Brightness/Contrast** button(Figure 3-5) lets you to adjust the screen for optimum viewing.



**Figure 3-5** *Set Brightness/Contrast dialog box*

**1— Brightness slider control**

**2— Contrast slider control**



### **To adjust screen brightness and contrast:**

1. Press the **Brightness/Contrast** button.  
The Set Brightness/Contrast dialog box displays (Figure 3-5).
2. Select a slider control using the right ► or left ◀ arrow.
3. Press the up ▲ or down ▼ arrow to increase or decrease Brightness and Contrast.
4. Press **N/X** to close the Set Brightness/Contrast dialog box when you are finished.

The following sections provide general scan tool navigation information.

## 4.1 Screen Layout

Scan tool screens (Figure 4-1) may include the following sections:

- The **upper toolbar** contains test controls.
- The **buffer bar** shows how much data is stored in the scan tool memory
- The **main body** displays menus and test data.
- Four **LED indicators** show certain engine operating conditions that vary by manufacturer.

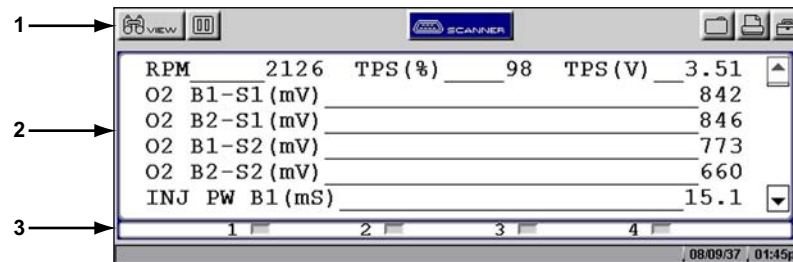


Figure 4-1 Sample Text screen layout

- 1— Upper toolbar
- 2— Main body
- 3— LED indicators

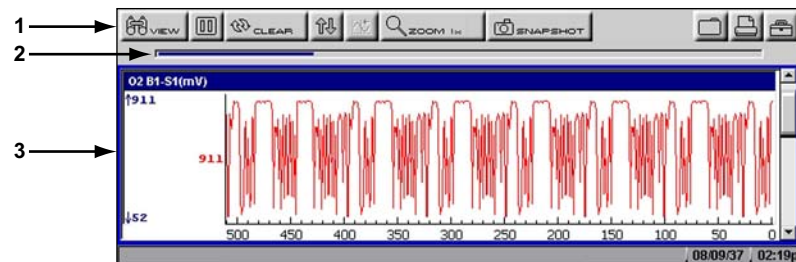


Figure 4-2 Sample Graph Screen layout

- 1— Upper toolbar
- 2— Buffer bar
- 3— Main body

### 4.1.1 Upper Toolbar

The upper toolbar (Figure 4-3 and Figure 4-4) controls vary depending on the mode and stage of operations (Table 4-1).



Figure 4-3 Sample upper toolbar—Text view



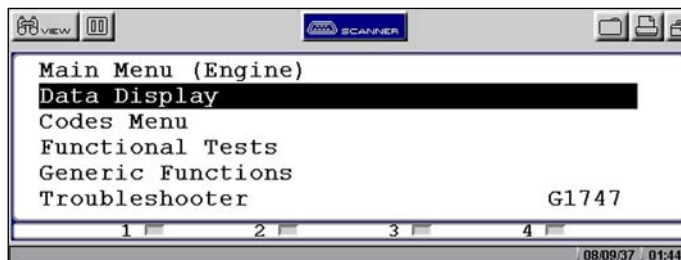
Figure 4-4 Sample upper toolbar—Graph view

Table 4-1 Upper toolbar controls

Name	Button	Description
View		Lets you change the way data displays
Pause		Stops data collection and lets you review the buffered data
Play		Continuously captures data and stores it in the Data Buffer
Clear		Erases all data from the Data Buffer
Sort		Lets you select the order in which the data displays
Review		Lets you scroll between frames of paused or recorded data
Scanner		Indicates when the Scanner screen is active
Cursor		Lets you make digital amplitude measurements of graph data
Zoom		Lets you change the magnification of the data or pick the number of PIDs displayed on-screen in the PID List view
Snapshot		Lets you capture a data recording using the PID Trigger or a manual snapshot
Save		Lets you store scanned vehicle data or save the current screen in memory
Print		Lets you print the displayed screen or a list of the current parameter values
Tools		Offers a shortcuts to Custom Setup, Save Data and Custom Data List. Custom Setup opens the Scanner Units dialog box, which lets you select how certain data values display. Save Data opens the Save Data dialog box that lets you configure how data is saved. Custom Data List lets you select which parameters are displayed.

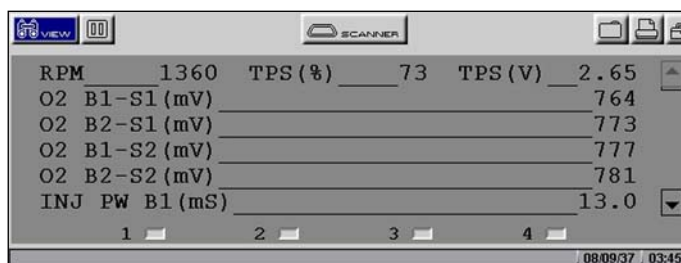
## Scanner Button

When the Scanner button is selected, the background of the main body turns white, indicating that the Text view is active (Figure 4-5). The up ▲ and down ▼ arrows and the **Y/✓** and **N/X** buttons are used for screen navigation.



**Figure 4-5** Active Scanner screen

When you select a different button from the upper toolbar using the left ◀ and right ▶ arrows in Text view, the background of the main body turns gray, indicating the screen is inactive (Figure 4-6). See “Terminating Vehicle Communication” on page 31 for more information.



**Figure 4-6** Inactive Scanner screen

### 4.1.2 Buffer Bar

The buffer bar displays in Graph and PID List modes and indicates the amount of data the scan tool is holding in temporary storage. When a snapshot is taken or a save option is selected, the scan tool retrieves some of this buffered data, captures data at the trigger point, and records additional data after the trigger point. This gives you a complete picture of what was happening before the fact, what occurred at the trigger point, and what happened after the fact.

As data collects, the buffer bar fills from left to right across the screen. A full buffer is indicated by a flashing vertical line at the right end of the buffer bar (Figure 4-7). Data continues to collect once the buffer is full, older data is deleted one frame at a time as new data is added.



**Figure 4-7** Sample full data buffer

You can adjust the percentage of data that is saved before and after the trigger through the Utilities Menu. See “Save Data” on page 56 for details.

### 4.1.3 Main Body

The main body (Figure 4-8) of the screen provides prompts. The prompts guide you through vehicle identification and task selection. Once communication is established with an ECM, parameter information can be displayed.

RPM	2126	TPS (%)	98	TPS (V)	3.51
O2 B1-S1 (mV)					842
O2 B2-S1 (mV)					846
O2 B1-S2 (mV)					773
O2 B2-S2 (mV)					660
INJ PW B1 (mS)					15.1

Figure 4-8 Sample Scanner main body in text view

### 4.1.4 LED Indicators

Four LED indicators appear at the bottom of the screen and show designated operating conditions. The LEDs can be programmed to show change of state for certain digital parameters, which vary by manufacturer.

## 4.2 Making Selections

Use the following instructions to navigate the interface and make selections.



#### To navigate the upper toolbar:

- Press the left ◀ and right ▶ arrows of the Thumb Pad.



#### To navigate the main body:

- Press the up ▲ and down ▼ arrows of the Thumb Pad.



#### To make selections:

1. Highlight a button or menu option.
2. Press Y/✓ to confirm the selection.

## 4.3 Using Easy Scroll

Instead of using the Thumb Pad to highlight an item and the Y/✓ button to select it, Easy Scroll lets you use only the Thumb Pad arrows to highlight and select items.

Easy Scroll works in the following ways:

- The up ▲ and down ▼ arrows navigate menus.

- The right ► arrow works like the **Y/✓** button to confirm the selection of menu items.
- The left ◀ arrow works like the **N/X** button for cancelling, exiting, and closing menus.

See “Easy Scroll” on page 62 for information on activating Easy Scroll.

## 4.4 Screen Messages

There are three types of on-screen messages:

- Confirmations
- Warnings
- Errors



**To manage on-screen messages:**

- Press **Y/✓** or **N/X** as indicated in the message.

### 4.4.1 Confirmation Messages

Confirmation messages inform you when you are about to perform an action that cannot be reversed or when an action has been initiated and your confirmation is needed to continue.

When a user-response is not required, the message displays briefly before automatically disappearing.

### 4.4.2 Warning Messages

Warning messages inform you when completing the selected action may result in an irreversible change or loss of data.

### 4.4.3 Error Messages

Error messages inform you when a system or procedural error has occurred.

Examples of possible errors include:

- A cable is disconnected.
- A peripheral, such as a printer is powered off.
- A CompactFlash<sup>®</sup> card is inserted improperly.

This section explains general scan tool operations and offers instructions for customizing certain tool functions.

The following is an outline of basic operations.



**NOTE:**

The sequence of steps may vary depending on manufacturer or model of the test vehicle. See the Vehicle Communication Software manuals for detailed procedures.

1. **Select the manufacturer**—Select and load the software database for the manufacturer of the test vehicle. See “Selecting the Manufacturer” on page 25.
2. **Identify the vehicle**—Identify the test vehicle to the scan tool by entering VIN characters and answering questions. See “Identifying the Vehicle” on page 25.
3. **Select the system**—Enter the system to be tested (engine, transmission, ABS, etc.). See “Selecting a System” on page 26.
4. **Connect the scan tool to the vehicle**—Follow the on-screen connection instructions to connect the scan tool to the vehicle. See “Connecting to a Vehicle” on page 26.
5. **Select the required test from the menu**—Select tests for the vehicle you have identified. See “Selecting from the System Main Menu” on page 27.

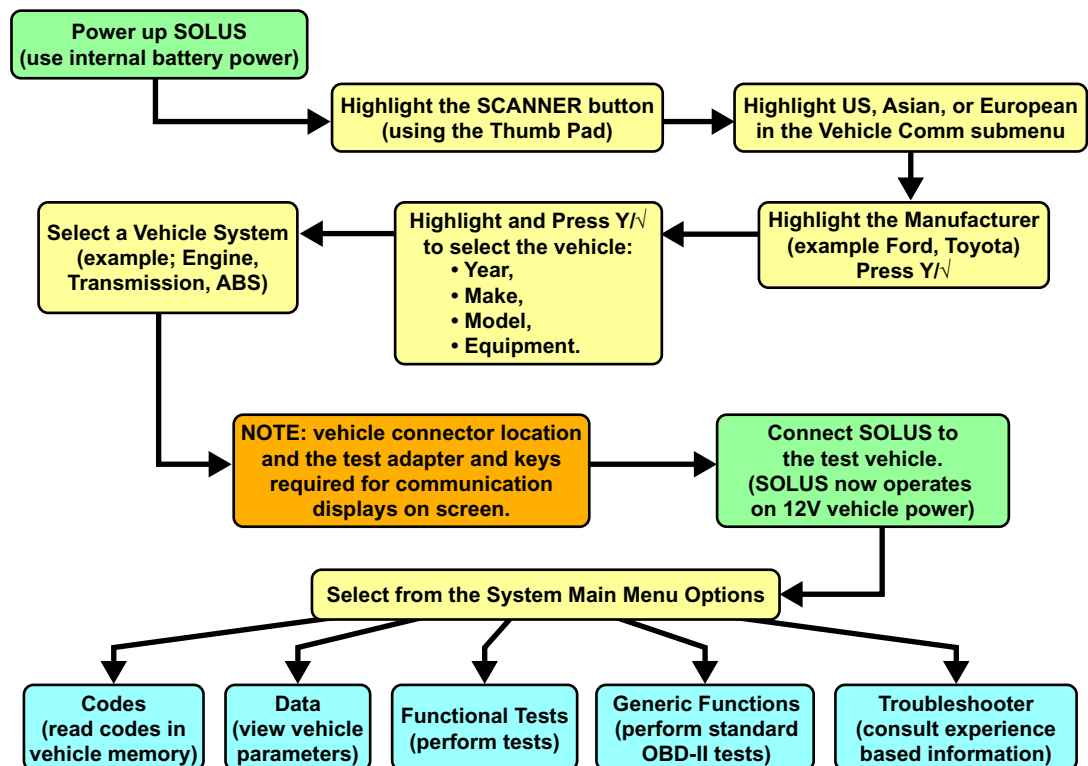


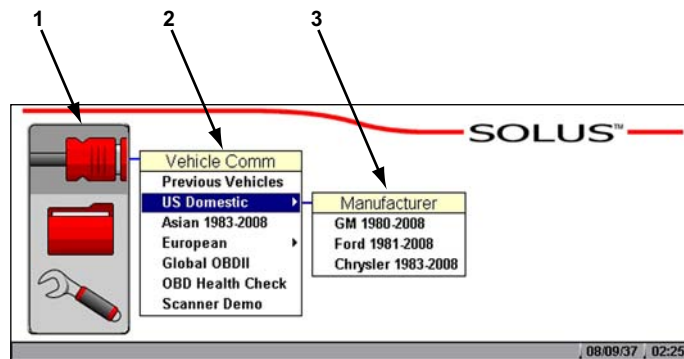
Figure 5-1 Basic scan tool operations

## 5.1 Selecting the Manufacturer



Vehicle manufacturers are organized into categories:

- Previous Vehicles—for recently tested vehicles
- EOBD—for any EOBD vehicle
- OBD Health Check—for any OBD-II/EOBD vehicle
- An alphabetical list of manufacturer



- 1— Scanner function  
 2— Vehicle Communication menu  
 3— Submenu

Figure 5-2 Scanner main menu software selection



**To select the manufacturer:**

1. From the main menu, select **Scanner**.  
The Vehicle Communication menu displays (Figure 5-2):
2. Select from the submenus as necessary.  
The database loads, then a confirmation screen displays.
3. Press **Y/✓** to continue.

## 5.2 Identifying the Vehicle

After you select the manufacturer, you are ready to identify the specific vehicle to be tested.



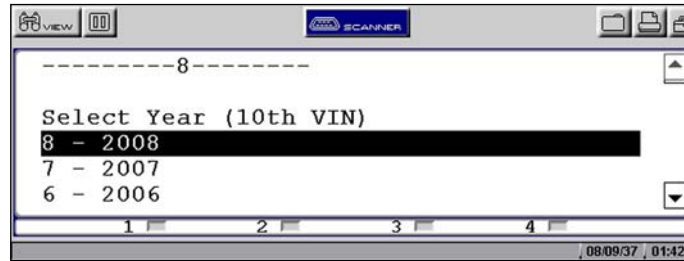
**NOTE:**

The exact procedure varies depending on the manufacturer. Screen prompts will guide you through the procedure.



**To identify a vehicle:**

1. Once the database loads, the first vehicle identification (ID) screen displays (Figure 5-3).



**Figure 5-3** Sample Vehicle ID screen

2. Press the up ▲ and down ▼ arrows on the Thumb Pad until the correct choice is shown, then press **Y/✓**.
3. Continue by entering choices and pressing **Y/✓** or **N/X** to answer the on-screen questions as necessary.

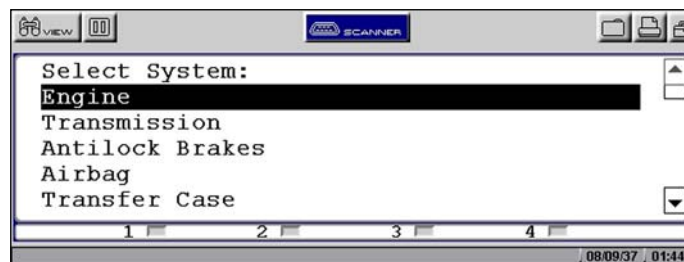
Once the vehicle identification is complete, a Select System menu displays (Figure 5-4).

## 5.3 Selecting a System

You must select the vehicle control system you wish to test (Figure 5-4).

**To select a system:**

1. Press the up ▲ and down ▼ arrows so the cursor is at the system you wish to test.
2. Press **Y/✓** to select.



**Figure 5-4** Sample system selection screen

## 5.4 Connecting to a Vehicle

Connection instructions prompt you to connect the scan tool to a vehicle diagnostic connector for testing (Figure 5-5).

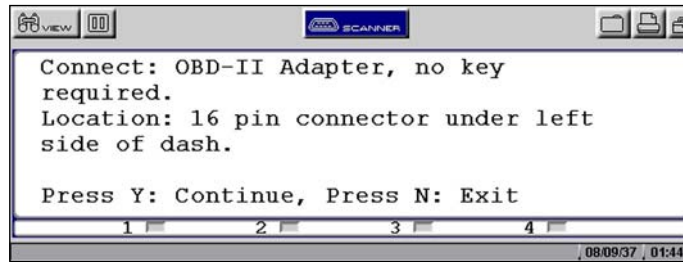


Figure 5-5 Sample connection instruction screen

Follow the on-screen connection instructions, then press **Y/✓** to open the system Main Menu.

## 5.5 Selecting from the System Main Menu

Depending on the vehicle, a number of options may be available on the system main menu (Figure 5-6). See "Using the Scanner Functions" on page 27.

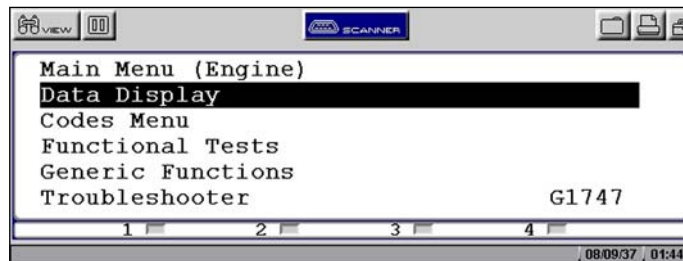


Figure 5-6 Sample system main menu

## 5.6 Using the Scanner Functions

System main menu options vary by make and model and may include the following:

- **Data or Data Display**—displays data parameter information from the vehicle control module. selecting may open a submenu of viewing options.
- **Codes or Codes Menu**—displays diagnostic trouble code (DTC) records from the vehicle control module. selecting may open a submenu of viewing options.
- **Functional Tests**—provides specific subsystem and component tests. The tests vary depending on the manufacturer and model.
- **Troubleshooter**—provides step-by-step procedures, integrating parameter data and retrieving trouble codes when appropriate, for specific symptoms of the identified vehicle.

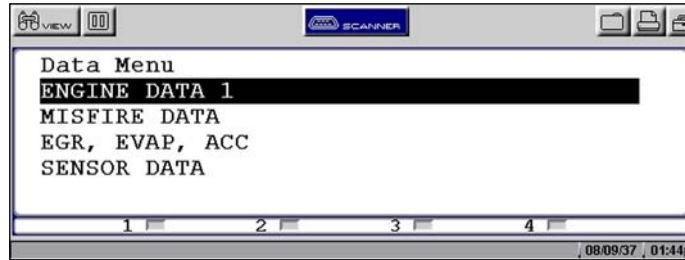
### 5.6.1 Data Display

Selecting **Data** or **Data Display** on the system Main Menu has one of the following results:

- A submenu of data viewing choices displays.

- Vehicle data displays.

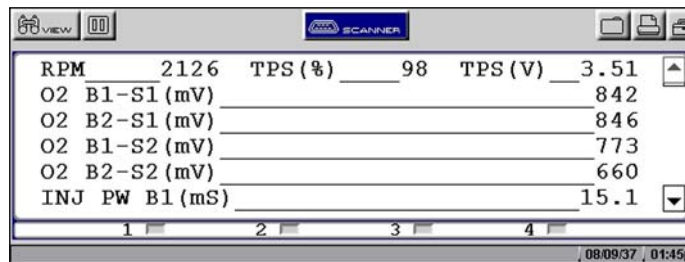
A submenu displays when more than one data viewing mode is available on the identified vehicle (Figure 5-7).



**Figure 5-7** Sample data submenu

On some models, the engine must be started or cranked before data can be displayed. For these models, a "Waiting to Communicate" message displays if the engine was not cranked or started.

Selecting from the Data Menu opens a list of data parameters (Figure 5-8).



**Figure 5-8** Sample engine data screen

The top line of the display remains fixed. In some cases, the second line shows the test mode name and also indicates whether or not the vehicle can be driven during testing.

## 5.6.2 Codes Menu

Selecting **Codes** or **Codes Menu** from the system main menu opens a list of data parameter viewing options. Codes Menu selections typically include:

- Display Codes
- Clear Codes
- Freeze Frame/Failure Records
- DTC Status

### Trouble Codes

Trouble Codes displays a list of diagnostic trouble codes (DTCs) stored in the selected electronic control module (ECM). Selecting opens a submenu of DTC viewing options on some models. Submenu options allow you to view more detailed DTC information.

## Clear Codes

The scan tool clears trouble codes from the control module memory on some vehicles. If this function is not available on the test vehicle, Clear Codes does not appear as a menu option.

## Freeze Frame/Failure Records

This selection displays the DTC that was set, along with corresponding data, when the ECM commanded the malfunction indicator lamp (MIL) to turn on.

## DTC Status

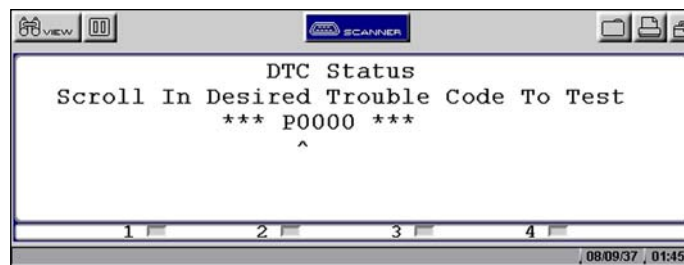
This selection allows you to see if a particular DTC caused the MIL to turn on.



### To check DTC status

1. Select **DTC Status** from the Codes Menu.

The DTC Status screen displays with the cursor at the second character of the code (Figure 5-9).



**Figure 5-9** Sample DTC Status entry screen

2. Use the up ▲ and down ▼ arrows to enter the second character.
3. Press **Y/✓** and the cursor moves to the third character.
4. Use the up ▲ and down ▼ arrows to enter the third character.
5. Press **Y/✓** and the cursor moves to the fourth character.
6. Use the up ▲ and down ▼ arrows to enter the fourth character.
7. Press **Y/✓** and the cursor moves to the fifth character.
8. Use the up ▲ and down ▼ arrows to enter the fifth character.
9. Press **Y/✓** and the status of the selected DTC displays (Figure 5-10).

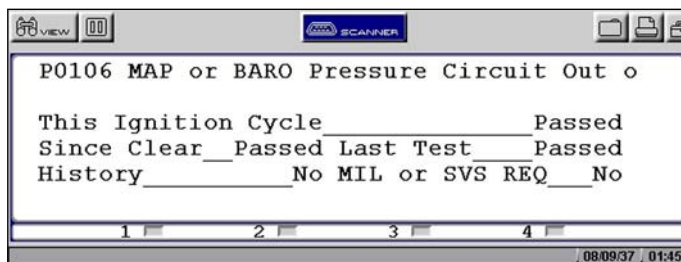


Figure 5-10 Sample DTC Status screen

10. Press **N/X** to return to the DTC status entry screen.
11. Press **N/X** again to return to the Codes menu.

### 5.6.3 Functional Tests

The **Functional Tests** selection is used to access vehicle-specific subsystem and component tests. Available tests vary by manufacturer, year, and model, and only the available tests display in the menu.

There are four general types of functional test operations:

- **Information Tests**—are read-only tests, like selecting “VIN” from a Functional Tests menu to display the VIN of the identified vehicle.
- **Toggle Tests**—switch a component, such as a solenoid, relay, or switch, between two operating states. The terms “on/off,” “open/clsd” (open/closed), “enab/disa” (enable/disable), and others may be used to identify the different states.
- **Variable Control Tests**—command a certain value for a system or component, such as varying spark timing in 1° increments or varying the EGR valve duty cycle in 10% increments.
- **Reset Tests**—reset the adaptive, or learned, values that are stored in the control module.

### 5.6.4 Troubleshooter

The Troubleshooter selection appears on the system Main Menu only if Fast-Track® Troubleshooter information is available. Fast-Track® Troubleshooter is a database of experience-based information of validated real-world repair strategies that top-notch technicians have compiled since 1988.

Select **Troubleshooter**, and a system menu may display (Figure 5-11).

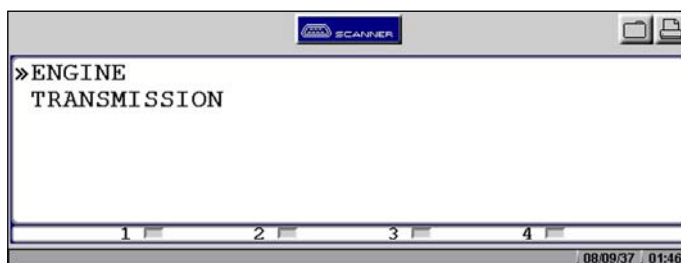
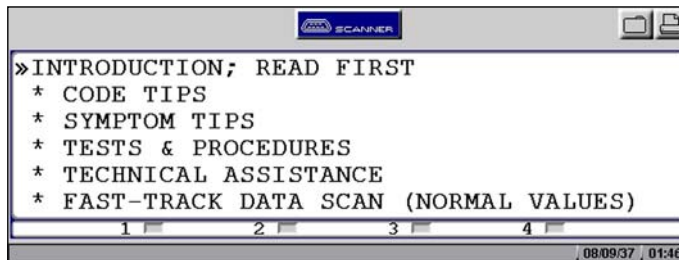


Figure 5-11 Sample Troubleshooter system menu

Select a system and a Troubleshooter Menu similar to Figure 5-12 displays.



**Figure 5-12** Sample Troubleshooter Menu

Troubleshooter menus vary by make, model, and system. Refer to the *Fast-Track® Troubleshooter Quick Reference Guide* for information.

## 5.7 Terminating Vehicle Communication

Once you have established communication with a vehicle, you must terminate communication with the vehicle control module in order to safely shut down the scan tool. Use the following procedures to terminate correctly.

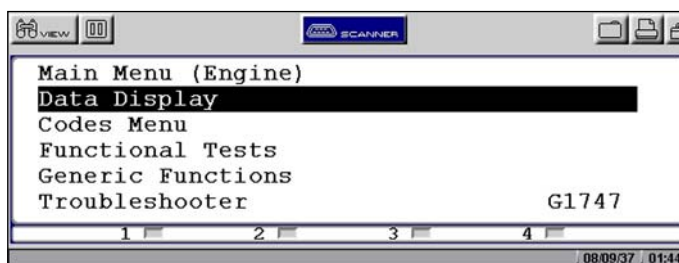
### IMPORTANT:

Damage to the vehicle may occur if communication is abruptly terminated.



#### To terminate communication from a manufacturer or Global OBD-II database:

- Press **N/X** until you reach the main menu (Figure 5-13).  
A “stopping communication” message appears briefly before the main menu displays.



**Figure 5-13** Sample Software Confirmation screen



#### To terminate communication using Legacy Software:

1. Press **N/X** until you reach the main menu.
2. Select **Other Systems** (Figure 5-14).

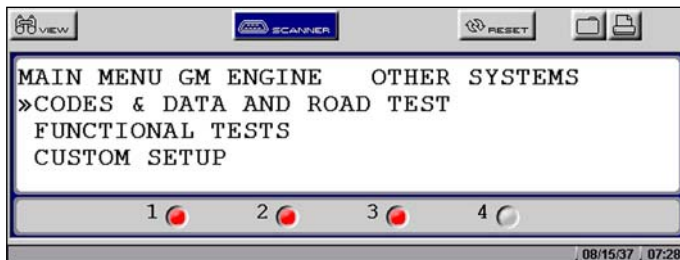


Figure 5-14 Sample Legacy Software main menu

3. When prompted to confirm your selection, press **Y/✓**.
4. *GM only*. Select **ABS (Exit & Re-ID)**.

### 5.7.1 Exiting Scanner Mode

Exit Scanner mode before powering off. The exit procedure differs depending on the view option.

**IMPORTANT:**

Exiting Scanner mode does not ensure that you have safely terminated communication with a vehicle. See “Terminating Vehicle Communication” on page 31. Also see “Scanner Button” on page 21 for additional information.



**To exit Scanner mode from text screens:**

1. Use right ► and left ◀ arrows to scroll the highlight off of the **Scanner** button.
2. Press **N/X** to return to the main menu.



**To exit Scanner mode from PID List or Graphs views:**

- Press **N/X** until you return to the main menu.

## 5.8 Viewing Data Graphically

The scan tool provides multiple options for viewing and sorting collected data.

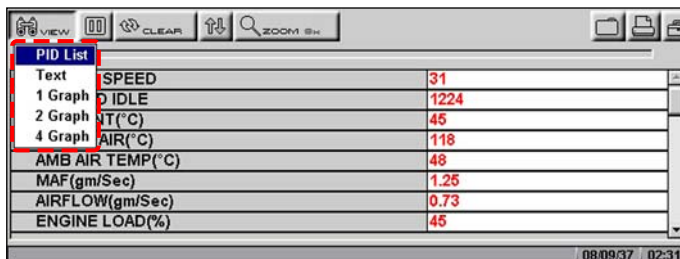


Figure 5-15 Sample View menu

### 5.8.1 Changing Screen Views

Data can be viewed in the following formats:

- Listed by PID
- Text view
- Graph view



**To change screen views:**

1. Select the **View** button.  
A drop-down menu displays (Figure 5-15).
2. Select an option from the menu.  
The screen layout changes to the selected format.

#### PID List View

The parameter identification (PID) List view displays all parameters in a table format. As many as eight parameters (Figure 5-16) can be viewed on one screen depending on the zoom setting (see “Using Zoom” on page 43 for more information).

ENGINE SPEED	21
DESIRED IDLE	696
COOLANT(°C)	49
INTAKE AIR(°C)	45
AMB AIR TEMP(°C)	54
MAF(gm/Sec)	0.82
AIRFLOW(gm/Sec)	1.03
ENGINE LOAD(%)	38

Figure 5-16 Sample PID List view

#### Reviewing PIDs

Review collected data by pausing the screen (Figure 5-17). Up to 512 frames of data are stored.

APP(%)	3
TPS(%)	2
MAP(kPa)	139
BARO(kPa)	81
CMMD. A/F EQUIVALANCE RATIO(:1)	0.0
LOOP STATUS	CLOSED
AIR PUMP	OFF
AIR SOLENOID	OFF

- 1— Pause/Play button
- 2— Review button



3— PID data

4— Buffer bar indicator

Figure 5-17 Sample paused upper toolbar in PID View



#### To review collected PID data:

1. Select the **Pause** button to stop the data collection.
2. Select the **Review** button and use the right ► and left ◀ arrows to scroll through the data stored in the buffer. The status bar indicator shows your position in the stored data.
3. Press **N/X** to release the **Review** button.
4. Select the **Play** button to cancel the pause and resume live data collection.

## Clearing the Buffer

You can lock Parameters in place for customized list viewing.

## Locking Parameters

You can lock Parameters in place for customized list viewing.



#### To lock a parameter:

1. From the upper toolbar, press the down ▼ arrow.
2. Select the parameter you want to lock.  
The parameter menu displays (Figure 5-18).

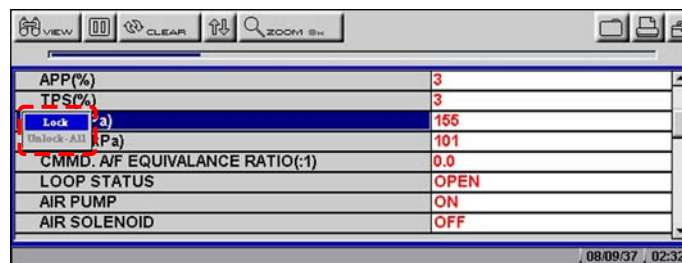


Figure 5-18 Sample parameter menu

3. Select **Lock**.  
A lock icon displays by the parameter, which now stays in place when you scroll (Figure 5-19).

Parameter	Value
APP(%)	3
TPS(%)	2
MAP (kPa)	167
BARO(kPa)	118
CMMD. A/F EQUIVALANCE RATIO(:1)	0.0
LOOP STATUS	CLOSED
AIR PUMP	ON
AIR SOLENOID	ON

Figure 5-19 Sample locked PID

4. Repeat the above steps to lock multiple parameters.
5. Press **N/X** to return to the upper toolbar.



**To unlock parameters:**

- Select a locked parameter and select **Unlock** when the parameter menu displays. The lock icon disappears and the parameter can be scrolled as before.



**NOTE:**

Select **Unlock All** to release all of the locked parameters at once.

## Text View

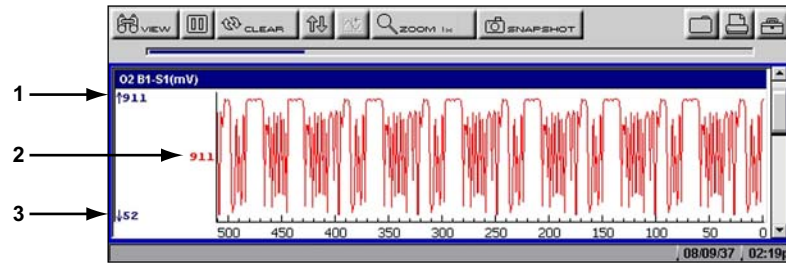
Text view displays parameters as plain text (Figure 5-20).

RPM	2126	TPS (%)	98	TPS (V)	3.51
O2 B1-S1 (mV)					842
O2 B2-S1 (mV)					846
O2 B1-S2 (mV)					773
O2 B2-S2 (mV)					660
INJ PW B1 (mS)					15.1

Figure 5-20 Sample Text view

## Graph View

The Graph view presents data in line graph format (Figure 5-21).



- 1— Maximum value of captured data
- 2— Current value
- 3— Minimum value of captured data

Figure 5-21 Sample graph screen

**Parameter Menu**

In Graph view, the scan tool offers a parameter menu (Figure 5-22) with the following options:

- **Lock**—locks the selected parameter into position to compare readings.
- **Unlock**—unlocks a single parameter.
- **Unlock All**—unlocks all locked parameters.
- **Auto Scale**—automatically scales the minimum and maximum values of the selected graph captured within the last 2000 points.
- **Manual Scale**—manually scales the minimum and maximum values of the selected graph.
- **Scale All**—automatically scales the minimum and maximum values of all the graphs.
- **Set Trigger Levels**—specifies automatic screen-pausing conditions when **Snapshot > PID Trigger** is used.
- **Clear Trigger Levels**—removes triggering conditions from the selected parameter.
- **Clear All Trigger Levels**—removes triggering conditions from all parameters simultaneously.

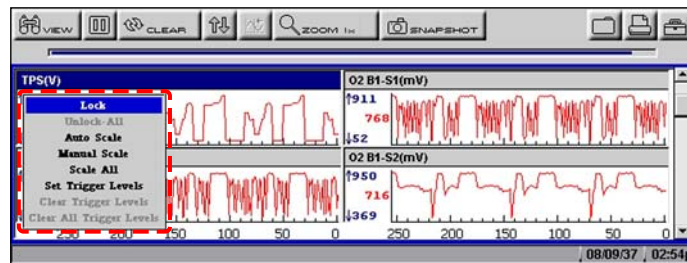
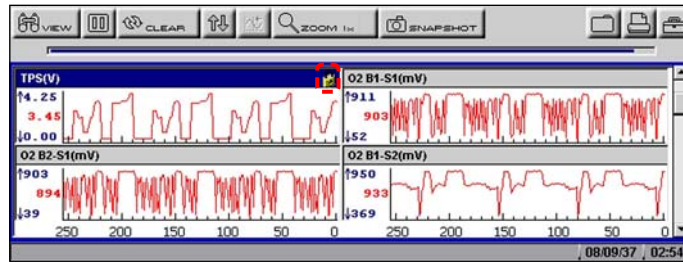


Figure 5-22 Sample parameter menu



**To lock a parameter:**

1. From the upper toolbar, press the down ▼ arrow.  
The highlight moves to the first parameter graph.
2. Select the parameter you want to lock.  
The parameter menu displays.
3. Select **Lock**.  
A lock icon displays (Figure 5-21). The locked graph will not move when you scroll through the remaining graphs.



**Figure 5-23** Lock icon indicating a locked parameter

4. Scroll other parameters into place to compare readings.



**To unlock a parameter:**

1. Select the locked parameter.  
The parameter menu displays.
2. Select **Unlock**.  
The lock icon disappears and the parameter can be scrolled as before.



**To unlock all parameters:**

1. When a PID is locked on-screen, select any parameter.  
The parameter menu displays.
2. Select **Unlock All**.  
All of the lock icons disappear and all of the locked parameters can now be scrolled.



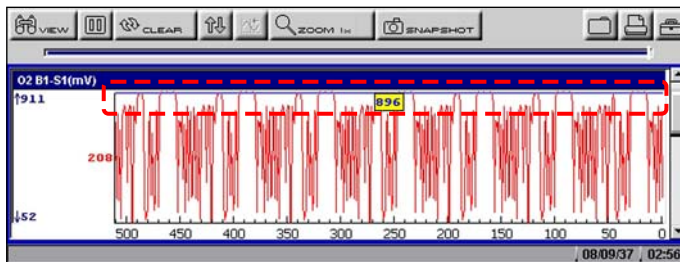
**To scale a parameter:**

1. Select a parameter.  
The parameter menu displays.
2. Select **Auto Scale**.  
The minimum and maximum graph values are reset for the selected parameter.



**To manually scale a parameter:**

1. Select a parameter.  
The parameter menu displays.
2. Select **Manual Scale**.  
A line displays across the top of the graph along with a box that displays the maximum recorded value (Figure 5-24).



**Figure 5-24** Sample manually scaling a parameter

3. Use the down ▼ arrow to move the maximum displayed value into position.
4. Press **Y/✓** to set the selected value.
5. Press **Y/✓** to scale the minimum value.
6. Use the up ▲ arrow to move the maximum displayed value into position.
7. Press **Y/✓** to set the selected value.
8. Press **N/X** to exit manual scale.

The top and bottom of the graph is now clipped so that only the portion that falls between the selected minimum and maximum values displays.



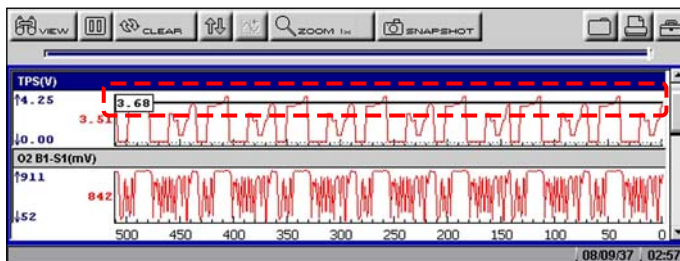
**To scale all parameters:**

1. Select a parameter.  
The parameter menu displays.
2. Select **Scale All**.  
The minimum and maximum graph values are reset for all of the parameters.



**To set trigger levels:**

1. Select a parameter.  
The parameter menu displays.
2. Select **Set Trigger Levels**.  
The active trigger level line displays as a solid black line together with an on-screen position value (Figure 5-25).



**Figure 5-25** Sample active trigger line

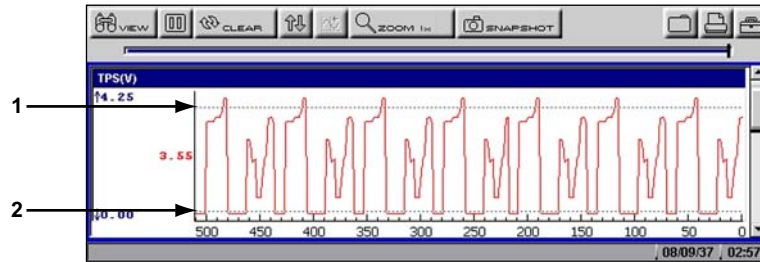


**NOTE:**

Both an upper and lower trigger level must be set.

3. Adjust the upper trigger level using the up ▲ and down ▼ arrows to place the trigger level line where you want it on the PID graph.

- Press **Y/✓** to set the trigger.  
When set, the solid black line changes to a dotted line and the position value no longer displays (Figure 5-26).



- 1— Upper trigger level
- 2— Lower trigger level

Figure 5-26 Sample set trigger levels

- Adjust the lower trigger level using the up ▲ and down ▼ arrows and press **Y/✓** to set it.  
The area between the two trigger levels establishes the triggering condition. Any data points that register outside of your set condition trigger the on-screen graphing to pause.
- Press **Y/✓** if you want to switch between trigger level lines during the setting process.
- When you finish setting your trigger level, press **N/X**.



**NOTE:**

Only three PIDs can have trigger levels set at one time, but only one of the conditions needs to be satisfied for triggering to occur.



**To arm PID Triggering:**

- From the upper toolbar, select **Snapshot > PID Trigger**.
- Select from the drop-down menu (Figure 5-27):
  - **PID Trigger**—begins collecting when a signal outside the set conditions occurs
  - **Manual**—begins collecting the next time the SNAPSHOT button is selected



Figure 5-27 Sample armed triggering

A check mark displays next to the selected menu option.

**Trigger Delay**

Once the trigger is detected, a collecting snapshot dialog box displays (Figure 5-28) and data after the trigger detection begins to collect.



Figure 5-28 Sample collecting snapshot dialog box

The amount of data collected is specified by the **% After Trigger** setting, found in **Utilities > Tool Setup > Save Data**. You can manually stop the snapshot by pressing **Y** at any time during the data collection.

Once data collection is finished, graphing on-screen stops and the Pause button automatically changes to the Play button (Figure 5-29).



Figure 5-29 Sample paused upper toolbar—Play button

Once data collection is finished, graphing on-screen stops and the Pause button automatically changes to the Play button. A vertical line now appears on each of the data graphs to indicate the triggering point. The trigger line on the parameter that triggered the snapshot is a different color than those on the other graphs (Figure 5-30). This makes it easy to determine which parameter caused the trigger.

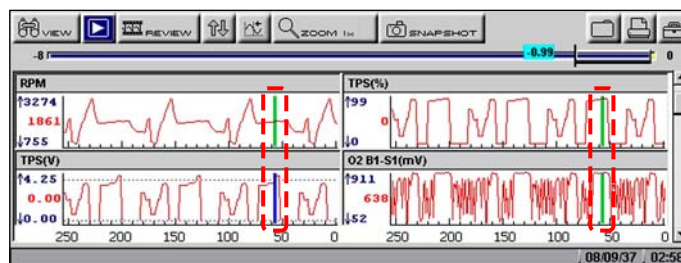


Figure 5-30 Sample trigger detection line



**To restart graphing:**

- Select the **Play** button (Figure 5-29).



**To clear trigger levels:**

1. Select a parameter.  
The parameter menu displays.
2. Select a **Clear** option.
  - **Clear Trigger Levels**—removes the trigger settings from the selected parameter only.
  - **Clear All Trigger Levels**—removes the trigger settings from all of the parameters with trigger settings.



**To disarm PID Triggering:**

- Select **SNAPSHOT > PID Trigger**.

The check mark next to the menu option disappears.

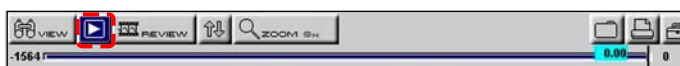
## 5.8.2 Pausing Data

The **Pause** button temporarily stops, or “pauses”, data collection when viewing parameter data in the PID List or Graphs views (Figure 5-31).



**Figure 5-31** Pause button viewing “live-screen” data

When the **Pause** button is selected, it changes to the **Play** button (Figure 5-32), which resumes data collection. A frame counter now displays on the buffer bar, and a vertical line now appears on the graphs at the point where the data collection was paused.



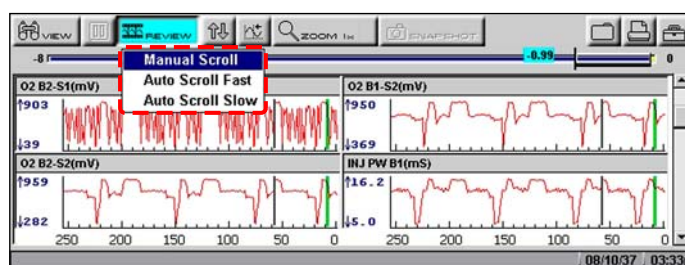
**Figure 5-32** Play button—viewing “paused-screen” data

The **Review** button on the toolbar becomes active when data collection is paused and the position indicator located just below the toolbar displays. The Review button allows you to scroll through and review frames of data.



### To review paused data:

1. Select the **Review** button.  
The Review button changes color to indicate it is selected.
2. Navigate through the data using the up ▲ and down ▼ arrows on the thumb pad:
  - a. Up ▲ moves you forward one frame at a time.
  - b. Down ▼ moves you backward one frame at a time.
 Scroll options are also available for reviewing the data.
3. With the **Review** button active, press **Y/✓** to change scroll options.  
A drop-down menu displays (Figure 5-33).



**Figure 5-33** Sample Scroll options menu

The following choices are available:

- Manual Scroll—use the up ▲ and down ▼ arrows to move through the data, this is the default setting.



- Auto Scroll Fast—automatically advances data in a continuous loop at normal speed. This is the recording speed, which is the transmission speed of the ECM.
  - Auto Scroll Slow—automatically advances data in a continuous loop at half speed.
4. Press **N/X** to deactivate the **Review** button.

### 5.8.3 Clearing the Data Buffer

The Clear button on the toolbar erases all of the data in the buffer. A confirmation screen displays when the Clear button is selected.

New data begins saving after the buffer has been cleared.

### 5.8.4 Sorting the Data

The Sort button on the toolbar allows you to arrange the parameter list three ways:

- Factory Sort—in the order transmitted by the electronic control module (ECM)
- A-Z Sort—in alphabetical ascending order
- Z-A Sort—in alphabetical descending order



**To sort the data list:**

1. Select the **Sort** button on the upper toolbar.
2. Highlight an option on the drop-down menu (Figure 5-34).

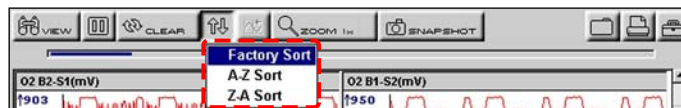


Figure 5-34 Sample sort drop-down menu

3. Press **Y/✓** to sort.



**NOTE:**

Any locked parameters are unlocked whenever a selection is made from the Sort button.

### 5.8.5 Using Cursors

When data is paused in Graph view, the **Cursor** button displays on the upper toolbar (Figure 5-35), which allows you to view digital amplitude measurements of frozen data.



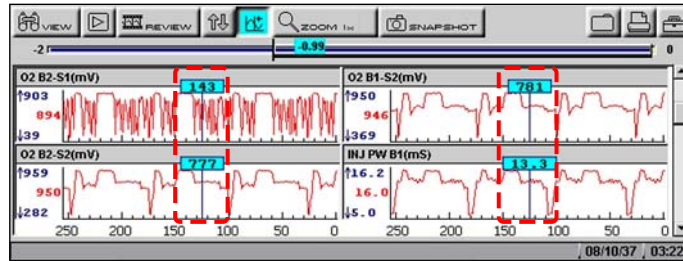
Figure 5-35 Sample paused screen with Cursors available



**To use the Cursor:**

1. Select the **Pause** button.
2. Select the **Cursor** button.

Cursor lines display (Figure 5-36). The value where the cursor line intersects the data displays above the cursor line.

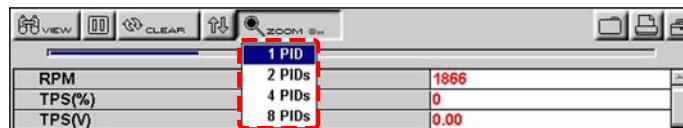


**Figure 5-36** Sample cursors on paused data

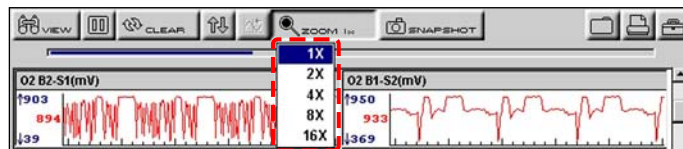
3. Press the left ◀ and right ▶ arrows to move the cursor.
4. Press **N/X** to exit the Cursor mode.

### 5.8.6 Using Zoom

The **Zoom** button lets you choose the number of parameters that display on-screen when used in the PID List view (Figure 5-37) and lets you choose different levels of magnification when used in the Graph view (Figure 5-38).

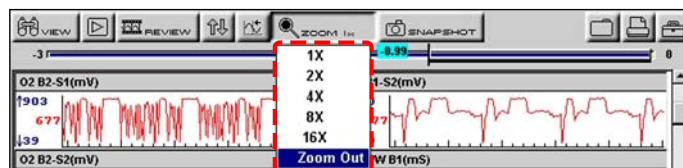


**Figure 5-37** Sample PID List Zoom options



**Figure 5-38** Sample Graph Zoom options

When viewing paused data, a Zoom Out selection is available (Figure 5-39).



**Figure 5-39** Sample Zoom options on paused data

Select Zoom Out and all of the data in the buffer displays on the graphs.

## 5.9 Saving Captured Data

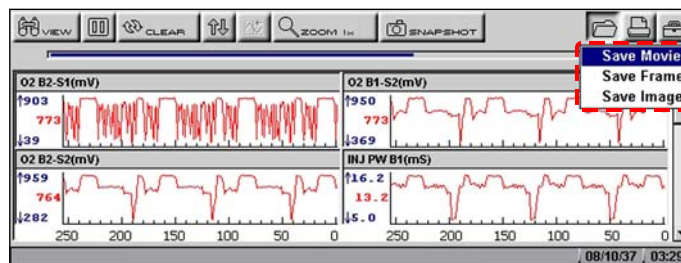
The scan tool provides multiple options for saving and reviewing captured data:

- **Save Movie**—This feature allows you to save up to 2000 frames of data (buffered data plus data transmitted after triggering) for each available parameter. Files can be saved from the Text, PID, and Graph views, but can only be replayed in the Graph view.
- **Save Frame**—This feature allows you to save up to 512 frames of buffered data (data held in scan tool memory) for each parameter. Pages can be saved from the Text, PID, and Graph views, but can only be replayed in the Graph view.
- **Save Image**—This feature allows you to capture a single screen as an image. Image files can be opened with common computer programs, such as Microsoft Paint.



**To save a movie file:**

1. Select the **Save** button from the toolbar.  
A drop-down menu displays (Figure 5-40).



**Figure 5-40** Save button menu

2. Select **Save Movie** from the drop-down menu.  
The Setup Saved Data Notation dialog box displays (Figure 5-41).



**Figure 5-41** Sample saved data notation box

3. Use the drop-down lists to enter vehicle information.
4. Select **Save** to close the dialog box.  
A saving data message displays. Once the message clears, the file is ready for reviewing.



**To review a movie file:**

1. Select the **Saved Data** button from the main menu.
2. Select the **Data Management** option (Figure 5-42).

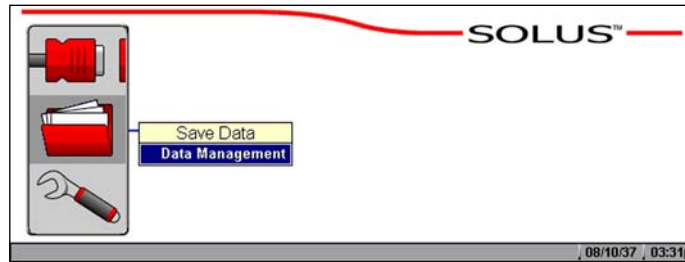


Figure 5-42 Data Management menu option

A list of all saved files displays.

3. Select the file that you would like to review (Figure 5-43).

 A screenshot of a data list window. The window has a toolbar at the top with buttons for LOAD, EDIT, DELETE, COPY, MOVE, SELECT ALL, INFO, and SETUP. Below the toolbar is a table with the following columns: Type, Size, Date/Time, Year, Make, Component, and Condition. The table contains several rows of data, with the first row highlighted in blue.
 

Type	Size	Date/Time	Year	Make	Component	Condition
JPEG	0.1%	08/10/37 15:31		User048_70810233135		
JPEG	0.1%	08/10/37 15:30		User047_70810233007		
JPEG	0.1%	08/10/37 15:25		User046_70810232554		
JPEG	0.1%	08/10/37 15:25		User045_70810232542		
JPEG	0.1%	08/10/37 15:24		User044_70810232413		
JPEG	0.1%	08/10/37 15:23		User043_70810232315		
JPEG	0.1%	08/10/37 15:23		User042_70810232301		

Figure 5-43 Sample saved data list

**NOTE:**



Movie files are saved with a SC(M) file type designation.

4. Select the **Review** button to set the data viewing speed.



**To save a frame file:**

1. Select the **Save** button from the toolbar.  
A drop-down menu displays (Figure 5-40).

**NOTE:**



The Setup button in the far right corner of the toolbar provides a shortcut to the Save Data menu (**Utilities > Tool Setup > Save Data**) so you can quickly reconfigure where and how the data is saved. See "Save Data" on page 56 for details.

2. Select **Save Frame** from the menu.  
The Setup Saved Data Notation dialog box displays (Figure 5-41).
3. Use the drop-down lists to enter vehicle information.
4. Select **Save** to close the dialog box.  
A saving data message displays. Once the message clears, the file is ready for reviewing.



**To review a frame file:**

1. Select the **Saved Data** button from the main menu.
2. Select the **Data Management** option (Figure 5-42).  
A list of all saved files displays.
3. Select the file that you would like to review (Figure 5-43).



**NOTE:**  
Frame files are saved with a SC(S) file type designation.



- To save an image file:**
1. Select the **Save** button from the toolbar.  
A drop-down menu displays (Figure 5-40).
  2. Select **Save Image** from the drop-down menu.  
The Saving screen image... message displays.



**NOTE:**  
The S button can be set to save an image file, see “S Button” on page 59 for details.



- To review an image file:**
1. Select the **Saved Data** button from the main menu.
  2. Select the **Data Management** option (Figure 5-42).
  3. A list of all saved files displays.
  4. Select the file that you would like to review.

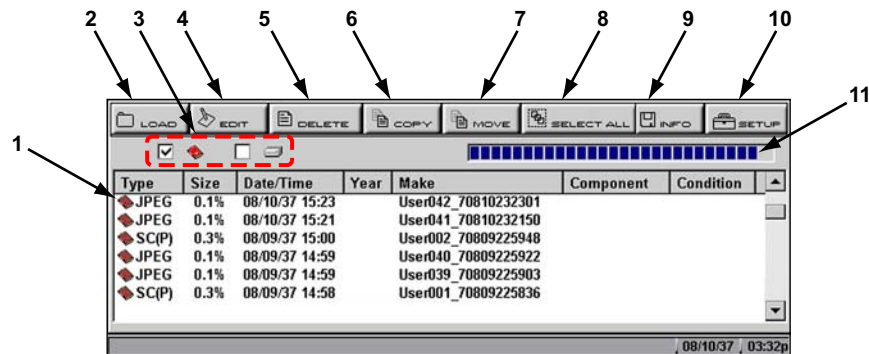


**NOTE:**  
Image files are saved with either a BMP or JPG file type designation.

## 5.10 Viewing Saved Data



Use the **Saved Data** button to access the Data Management screen option.  
The Data Management screen lets you manage your scan tool memory and your saved files (Figure 5-44).



**Figure 5-44** Sample Data Management screen

- 1— Saved data files**  
The saved files available depend on the CF Slot destination selected in the Setup menu.
- 2— Load button**  
Opens the saved file selected.

**3— CF Slot indicators**

Displays which CF Slot is selected in Setup. The left icon is CF Slot 2 and the right icon is CF Slot 1. The CF Slot 2 icon will be crossed out if there is no card in the slot when CF Slot 2 is the selected destination.

**4— Edit button**

Lets you edit data notations for selected files.

**5— Delete button**

Erases the selected file(s) from storage memory.

**6— Copy button**

Copies the selected file(s) from one CF slot to the other.

**7— Move button**

Moves the selected file(s) from one CF slot to the other.

**8— Select All button**

Selects all files.

**9— Info (information) button**

Displays the number of files saved and the amount of memory used and available.

**10— Setup button**

Configures how and where files are saved.

**11— CF memory indicator**

Displays the amount of CF card memory available.

## 5.10.1 Identifying Saved Files

Saved files have the following characteristics:

- **Type** identifies the kind of saved data file:
  - **SC(M)**—file saved from the **Save Movie** option on the toolbar.
  - **SC(S)**—file saved from the **Save Frame** option on the toolbar.
  - **SC(P)**—file saved from the **Snapshot** button on the toolbar.
  - **BMP**—file saved from the **Save Image** option on the toolbar.
  - **JPG**—file saved from the **Save Image** option on the toolbar.
  - **SPS**—designates bitmap files saved prior to the 7.2 software update.
- **Size** is the percentage of available storage space used.
- **Date/Time** is the date and time that the data was saved.
- **Year** is the vehicle model year.
- **Make** is the vehicle manufacturer.
- **Component** is the component tested.
- **Condition** is for good, bad, or unknown status options.



**To exit Data Management:**

- Press **N/X**.

## 5.10.2 Loading Saved Files

The **Load** button lets you review saved screen data and print the screen.



### To load data:

1. Select **Saved Data > Data Management**.  
The Data Management screen displays.
2. Select a file from the list.
3. Select **LOAD** from the upper toolbar.



### To exit the loaded screen:

1. Press **N/X** to return to the Data Management screen.
2. Press **N/X** again to return to the main menu.

## 5.10.3 Editing Saved Files

The **Edit** button opens the Setup Saved Data Notation dialog box (Figure 5-44). Use the dropdown lists to modify the vehicle information. Press **N/X** to exit.

## 5.10.4 Reviewing Saved Data

The **Review** button is used with the Thumb Pad to review data files.

There are two ways to review data files:

- Manually
- Automatically



### To review data files manually:

1. Select the **Review** button.
2. Use the right ► and left ◀ arrows to review data one frame at a time.



### To automatically scroll data files:

1. With the **Review** button selected, press **Y/✓** again to display a drop-down menu of options (Figure 5-45).



Figure 5-45 Sample Review scroll menu

2. From the **Review** menu, select an **Auto** option.
  - Auto Scroll Fast automatically scrolls the data at full-speed.
  - Auto Scroll Slow automatically scrolls the data at half-speed.
3. Press **N/X** to close the drop-down menu.

## 5.10.5 Deleting Saved Files

The **Delete** button lets you remove saved files from memory.

**NOTE:**

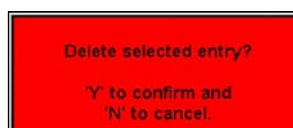
Factory-installed files cannot be deleted.

---

**To delete files:**

1. Select **Saved Data > Data Management**.
2. Select a file from the list.
3. Select **Delete** from the toolbar.

A confirmation message displays (Figure 5-46).



**Figure 5-46** Sample Delete file confirmation message

4. To remove the data permanently from memory, press **Y/✓**, or press **N/X** to keep the data and close the dialog box.  
Selected files are deleted, then the Data Management screen displays.

## 5.10.6 Copying and Moving Saved Data

The **Copy** and **Move** functions let you transfer your files from one CF card to the other.

**To copy or move data:**

1. From the main menu, select **Saved Data > Data Management**.  
The Data Management screen displays.
2. Select **Setup** from the toolbar.  
The Save Data dialog box displays.
3. Set **CF 1** as the **Save To** option and press **N/X** to close the dialog box.  
The test data saved to CF 1 displays.
4. Use the up ▲ and down ▼ arrows to highlight a file from the list on-screen.
5. Use right ► and left ◀ arrows to select **Copy** or **Move** from the upper toolbar.  
A confirmation message displays.
6. Press **Y/✓** to close the message box.  
The Data Management screen displays.

**NOTE:**

Factory installed files cannot be deleted, copied or moved.

---



### 5.10.7 Selecting All Files

Use the **Select All** button to highlight all files on-screen so you can delete, copy, or move the files as needed (Figure 5-47).

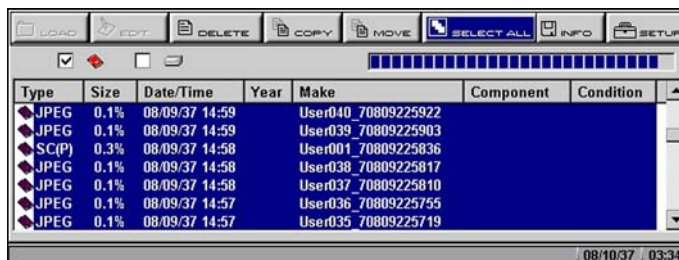


Figure 5-47 Sample Select All screen

### 5.10.8 Viewing Saved Data Information

Selecting the **Info** button on the toolbar opens a window that provides detailed information about the saved data files, such as the amount of storage memory used and the capacity of the memory storage media (Figure 5-48). Only details for the selected “Save to” destination display.



Figure 5-48 Sample Info button window

### 5.10.9 Setting a Destination for Saved Data

Use the **Setup** button to set the destination for saved files (Figure 5-49).

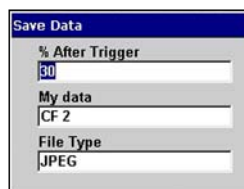


Figure 5-49 Sample Save Data dialog box



**To change the destination for saved files:**

1. Select **Saved Data > Data Management**.

The Data Management screen displays.

2. Select the **Setup** button.  
The **Save Data** dialog box displays.
3. Select the **My data** field.
4. Select an option from the drop-down list.  
The drop-down list closes automatically.
5. Press **N/X** to close the Save Data dialog box.  
The checkbox for the CF slot you selected is checked (Figure 5-50).

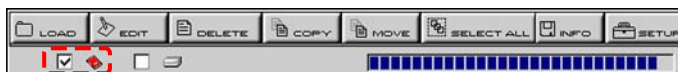


Figure 5-50 CF slot indicator checked

## 5.11 Printing

The **Print** button lets you print the displayed screen. The following print options may be available:

- **Full Screen**—print only what is visible on the screen.
- **Full PID List**—prints the entire list of parameters.
- **Full Codes List**—prints the list of codes in vehicle memory when viewing codes.



### To print:

1. Verify that your printer and scan tool are set up properly for printing. See “Setting Up to Print” on page 16 for details.
2. Point the IR output on the top of the scan tool at the IR receiver on your printer.
3. Select **Print >** print option (Figure 5-51).



Figure 5-51 Sample Print menu

When printing begins, an “Initializing printer” message displays. The message box closes when printing is complete.



### NOTE:

Keep the IR output of the scan tool pointed at the IR receiver on the printer until printing is completed.

## 5.12 Tools Button

The **Tools** button on the upper toolbar provides a shortcut to commonly used scan tool configuration settings (Figure 5-52).

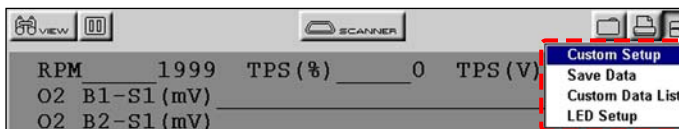


Figure 5-52 Sample Tools button menu

The following choices are available on a dropdown menu:

- Custom Setup
- Save Data
- Custom Data List
- LED Setup



**NOTE:**

The Custom Data List and LED Setup selections are only available when in the Text view mode, these menu selections do not display when in Graph or PID List modes.

### 5.12.1 Custom Setup

Selecting **Custom Setup** opens the Scanner Units dialog box. Scanner Units is used to change the units of measurement for certain parameters. You can choose between US Customary or metric units of measure for available data parameters.

All measurement units return to their default values when the internal batteries are disconnected or a different software database is selected.

Table 5-1 Units of measurement—defaults and options

SETTING	DEFAULT	OPTION
Temperature	degrees Celsius (°C)	degrees Fahrenheit (°F)
Air Pressure (including manifold pressure)	kilopascals (kPa)	inches of mercury ("Hg)
Speed	kilometers per hour (kph)	miles per hour (mph)
Other Pressures	kilopascals (kPa)	pounds per square inch (psi)



**To change a setting:**

1. On the upper toolbar, select **Tools > Custom Setup**.  
The Scanner Units dialog box displays (Figure 5-59).

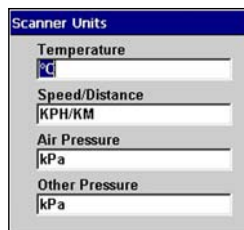


Figure 5-53 Sample Scanner Units Menu

2. Use right ► and left ◀ arrows to move between measurements, press **Y/✓** to open a dropdown menu for the item to be changed.
3. Select the desired measurement and the dropdown closes.
4. Press **N/X** to confirm your selections and return to the Tools Setup menu.

### 5.12.2 Save Data

Selecting **Save Data** from the dropdown menu opens the Save Data dialog box, which allows you to select where and how data is saved. Refer to “Setting a Destination for Saved Data” on page 50 for details.

### 5.12.3 Custom Data List

The **Custom Data List** selection, which is used to select specific data parameters to display, is only available in the Text view mode. This allows you to focus on any suspicious or symptom-specific data parameters and may allow for a faster display update rate.

Custom Data List selections are retained in the tool memory until a new vehicle ID is entered or another vehicle control system is selected for testing.



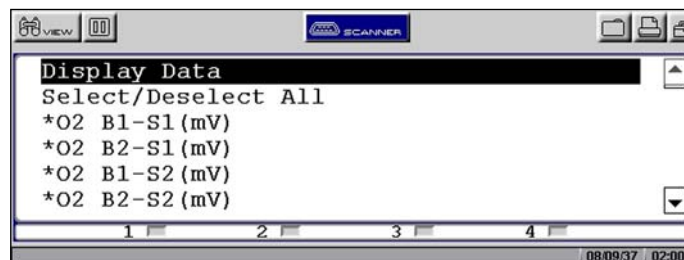
**NOTE:**

If a parameter is not selected for display in the Custom Data List, it will not be displayed when you enter Troubleshooter.



**To select a custom data list:**

1. On the upper toolbar, select **Custom Data List**.  
The Data Selection screen displays. An asterisk (\*) next to a parameter title indicates that parameter is selected for display (Figure 5-54).



**Figure 5-54** Sample Data Selection screen

2. Select or deselect the desired parameters.
3. Select **Display Data** or press **N/X** to confirm your selections and return to the data display to view the customized data list.

## 5.12.4 LED Setup

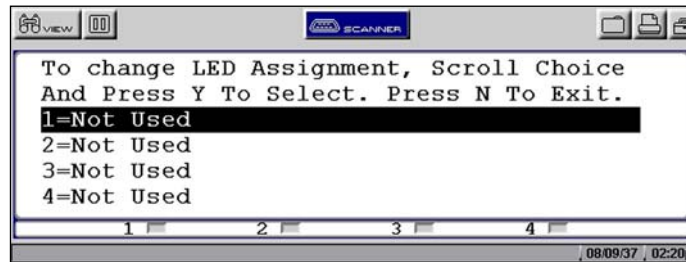
The LED Setup selection is used to program the operation of the four LEDs located just below the main body of the Scanner screen. The LEDs switch on and off to reflect a change of state for the assigned digital parameters. An LED turns red when switched on.



**To program LED operation:**

1. On the upper toolbar, select **Tools > LED Setup**.

The LED assignment menu opens with LED 1 highlighted (Figure 5-55).



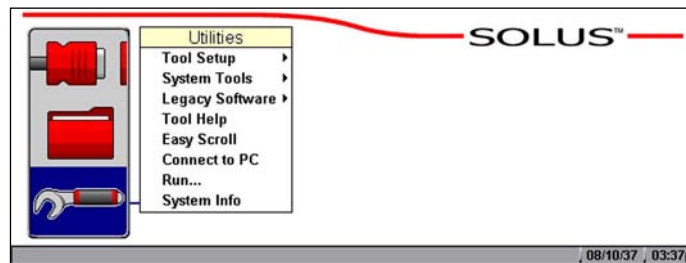
**Figure 5-55** Sample LED assignment menu

2. Use the up ▲ and down ▼ arrows to scroll through the list of available parameters.
3. Press **Y/✓** to lock in a selection and move the highlight to the next LED.
4. Press **N/X** to close the menu and return to the data display once all the LEDs are assigned.

## 5.13 Utilities



The **Utilities** button provides access to system information and controls (Figure 5-56).

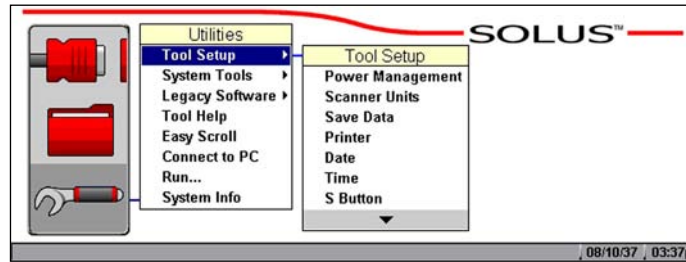


**Figure 5-56** Sample Utilities menu

The Utilities options available are discussed in the following sections.

### 5.13.1 Tool Setup

The Tool Setup submenu (Figure 5-57) lets you adjust certain settings for optimum performance.



**Figure 5-57** *Tool Setup sample menu*

The Tool Setup submenu includes the following options:

- “Power Management”
- “Scanner Units”
- “Save Data”
- “Printer”
- “Date”
- “Time”
- “S Button”
- “Color Theme”
- “Scanner View”
- “Navigation Prompts”

## Power Management

The Power Management option lets you select several backlight options.

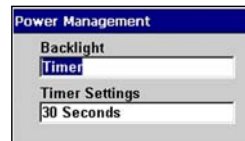
- **Timer**—The backlight turns off at the set time.
- **On**—The backlight remains on at all times.
- **Off**—The backlight remains off at all times.

For related information, see “Powering Off the Unit” on page 17.



**To set power management options:**

1. Select **Utilities > Tool Setup > Power Management**.  
The Power Management dialog box displays (Figure 5-58).



**Figure 5-58** *Sample power management dialog box*

2. Select from the drop-down lists as necessary.  
The drop-down list closes automatically once a selection is made.
3. Press **N/X** to close the Power Management dialog box.

## Scanner Units

The **Scanner Units** selection is used to change the units of measurement. Choose between US Customary or metric units of measure for available data parameters.

All measurement units return to their default values when the internal batteries are disconnected or different software is selected.

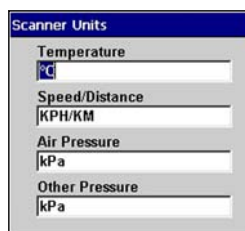
**Table 5-2** *Units of measurement—defaults and options*

Setting	Default	Option
Temperature	degrees Celsius (°C)	degrees Fahrenheit (°F)
Air Pressure (including manifold pressure)	kilopascals (kPa)	inches of mercury ("Hg)
Speed	kilometers per hour (kph)	miles per hour (mph)
Other Pressures	kilopascals (kPa)	pounds per square inch (psi)



### To change a setting:

1. Select **Utilities > Tool Setup > Scanner Units**.  
The Scanner Units dialog box displays (Figure 5-59).



**Figure 5-59** *Sample Scanner Units dialog box*

2. Select from the drop-down lists as necessary.  
The drop-down list closes automatically once a selection is made.
3. Press **N/X** to close the Scanner Units dialog box.

## Save Data

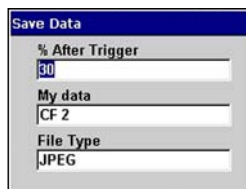
Selecting **Save Data** lets you adjust the amount of data recorded after a trigger-point. Save Data also lets you set the saving and loading location for all saved files, and whether to save image files in bitmap or jpeg format.

See “Setting a Destination for Saved Data” on page 50. Use the procedure below to adjust saving preferences.



### To adjust saving preferences:

1. From the main menu, select **Utilities > Tool Setup > Save Data**.  
The Save Data dialog box displays (Figure 5-60).



**Figure 5-60** Sample Save Data dialog box

2. Select from the drop-down lists as necessary:
  - **% After Trigger** determines how much new data is collected. At the default setting (30%), 30 percent of the saved file will be newly collected data and 70 percent will be retrieved from data stored in the buffer.
  - **My data** determines which CF card slot will be used to store saved data.

The drop-down list closes automatically once a selection is made.
3. Press **N/X** to close the Save Data dialog box.



**NOTE:**

The Save Data dialog box can also be accessed from the Setup menu on the saved data management screen.

## Printer

Select **Printer** to check the printer compatibility status.

Your scan tool supports infrared (IR) printing to PCL 3 (Printer Command Language Level 3) printers, such as the Hewlett-Packard (HP) PCL 3 standard, which supports some HP deskjet and inkjet printers (color and black & white). Contact the Hewlett-Packard Development Company to see if your printer supports the PCL 3 standard.



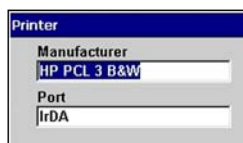
**NOTE:**

There are several aftermarket IR print adapters that will extend the printer compatibility of your scan tool.



**To check the printer compatibility status:**

1. Select **Utilities > Tool Setup > Printer**.  
The Printer dialog box displays.
2. Select from the drop-down lists as necessary (Figure 5-61).



**Figure 5-61** Sample Printer dialog box

3. Press **N/X** to close the Printer dialog box.



## Date

Selecting **Date** lets you set the date that displays in the Saved Data properties.



### To set the date:

1. Select **Utilities > Tool Setup > Date**.  
The Date dialog box displays.
2. Select the **Day**, **Month**, **Year**, or **Style** field.  
A drop-down list displays (Figure 5-62).



**Figure 5-62** *Sample Date dialog box*

3. Select an option from the drop-down list.  
The drop-down list closes automatically.
4. Press **N/X** to close the Date dialog box.

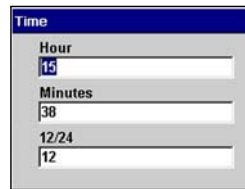
## Time

Selecting **Time** lets you set the time that displays in the Saved Data properties.



### To set the time on the system:

1. Select **Utilities > Tool Setup > Time**.  
The Time dialog box displays (Figure 5-63).



**Figure 5-63** *Sample Time dialog box*

2. Select the **Hour**, **Minutes**, or **12/24** field.  
A drop-down list displays.
3. Select an option from the drop-down list.  
The drop-down list closes automatically.
4. Press **N/X** to close the Time dialog box.

## S Button

Selecting **S Button** allows you to change the functionality of the **S** button. Possible function assignments include:

- **Save Image**—is the default and takes a snapshot of the current screen. The snapshot is saved as either a bitmap or a jpeg image, which can be opened using standard Internet browsers or graphics applications. This feature works anywhere in scan tool operations.
- **Freeze/Run**—works as the Pause/Play button when viewing data in the Graphs or PID List views. See “Pausing Data” on page 41 for details.
- **Save Frame**—works as the **Save Frame** selection from the Save button in the upper toolbar when this option is available. See “Saving Captured Data” on page 44 for details.
- **Print List**—works like the **Full PID List** selection from the Print button in the upper toolbar. See “Printing” on page 51 for details.
- **Print Page**—works like the **Full Screen** selection from the Print button in the upper toolbar. See “Printing” on page 51 for details.
- **S Button Popup**—opens the menu when the button is pressed so you can quickly select from any of the available functions.

---

### NOTE:



The **S** button can only perform print functions when the **Print** button is visible in the upper toolbar.

---



### To assign a function to the S button:

1. Select **Utilities > Tool Setup > S Button**.  
The **S Button** dialog box displays.
2. Press **Y/✓** to open the drop-down list (Figure 5-64).

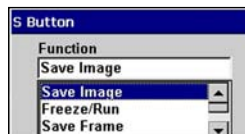


Figure 5-64 Sample S Button dialog box

3. Select a function from the drop-down list.
4. Press **N/X** to close the dialog box.

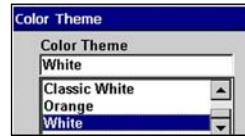
## Color Theme

**Color Theme** lets you select a black or white background for the screen. Using the black background helps conserve battery power



### To select a Color Theme:

1. Select **Utilities > Tool Setup > Color Theme**.  
The Color Theme dialog box displays.
2. Press **Y/✓** to open the drop-down list (Figure 5-65).



**Figure 5-65** Color Theme Menu

3. Select a function from the drop-down list.
4. Press **N/X** to close the dialog box.

## Scanner View

Scanner View sets the default setting for how the data displays. Scanner View options include:

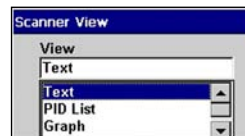
- Text
- PID List
- Graph
- Last Used View

See “Changing Screen Views” on page 33 for additional information.



### To select a Scanner View:

1. Select **Utilities > Tool Setup > Scanner View**.  
The Scanner View dialog box displays.
2. Press **Y/✓** to display a drop-down list (Figure 5-66).



**Figure 5-66** Sample Scanner View menu

3. Select an option from the drop-down list and the drop-down list closes automatically.
4. Press **N/X** to close the Scanner View dialog box.

## Navigation Prompts

This utility lets you set on-screen control button references to match the hardware. Control button references can be set to display as **Y/N** or **✓/X**.



### To set navigation prompts:

1. From the main menu, select **Utilities > Tool Setup > Navigation Prompts**.
2. The Navigation Prompts dialog box displays.
3. Select a set of control button references from the dropdown list.
4. Press **N/X** to close the dialog box.

## 5.13.2 System Tools

The **System Tools** submenu (Figure 5-67) lets you perform system maintenance functions.

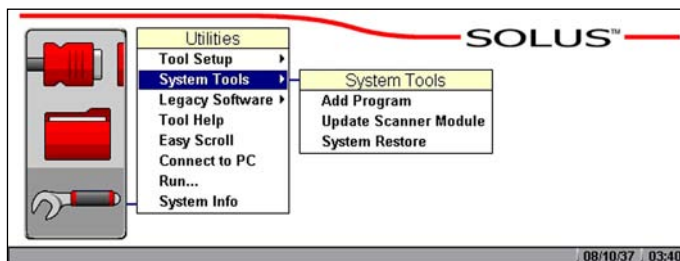


Figure 5-67 Sample System Tools submenu

System Tool options include:

- **Add Program**—lets you add optional software.
- **Update Scanner Module**—When instructed by a Help Desk representative to use, lets you update the Scanner module files.
- **System Restore**—lets you reinstall your system software.

## 5.13.3 Tool Help

Tool Help provides general operation and navigation from this manual.



### To use Tool Help:

1. Select **Utilities > Tool Help**.  
The Tool Help screen displays (Figure 5-68).

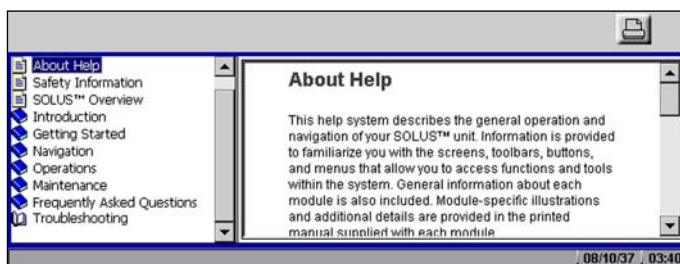


Figure 5-68 Sample Tool Help screen

2. Press the down ▼ arrow to move the highlight to the Contents frame.
3. Select a topic in the Contents frame.  
The topic text displays in the right frame.
4. Press the right ► arrow to move screen focus to the right frame, and press the up ▲ and down ▼ arrows as needed to scroll through additional text.
5. Press the left ◀ arrow to return to the Contents frame.



### To exit Tool Help:

- Press **N/X** twice.

### 5.13.4 Easy Scroll

The Easy Scroll utility functions as a selection shortcut that lets you use only the Thumb Pad arrows to highlight and select an item.

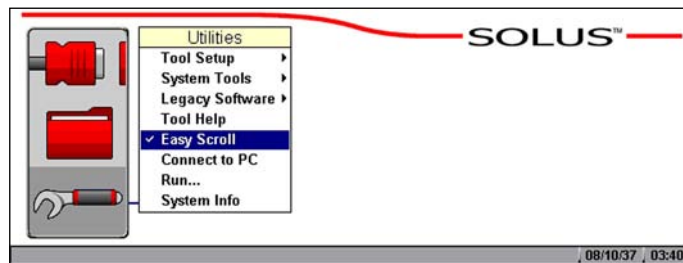
See “Using Easy Scroll” on page 22 for information on navigating with Easy Scroll.



**To turn Easy Scroll on and off:**

- Select **Utilities > Easy Scroll**.

A check mark to the right of the **Easy Scroll** option indicates that the utility is on (Figure 5-69).



**Figure 5-69** Easy Scroll turned on



**NOTE:**

Easy Scroll stays on until you manually turn it off.

### 5.13.5 Connect to PC

The **Connect to PC** selection is used with the optional ShopStream Connect™ software, which lets you view data files on a computer and share files.

### 5.13.6 Run

The **Run** option is used to access special Snap-on® CF card applications.



**To run special CF card applications:**

1. Insert the CF card containing the special application into CF Slot 2 on the top of the unit (Figure 2-3 on page 5).
2. Select **Utilities > Run**.  
The application begins.

### 5.13.7 System Info

The **System Info** option lets you view configuration information for your scan tool.

**To display the system information:**

1. Select **Utilities > System Info**.

The System Information screen displays. The left field of the screen shows the information menu and the right field displays the selected information. Navigate the information screens as follows:

- a. Press the down ▼ arrow to move the highlight from the Print button to the menu.
- b. Use the down ▼ and up ▲ arrows to highlight a menu item.
- c. Press **Y/✓** to select the highlighted menu item.

The selection now displays in the right field of the screen (Figure 5-70).



**Figure 5-70** Sample System Info screen

- d. Press the right ► arrow to move from the menu field to the information field.
  - e. Use the down ▼ and up ▲ arrows to scroll the information field.
  - f. Press the left ◀ arrow to return to the menu field.
2. Press the **N/X** twice to exit System Info and return to the main menu.

This section covers the following maintenance issues:

- Cleaning and damage inspection
- Battery replacement
- Storage tips
- Disposal requirements (environmental hazards)

## 6.1 Cleaning and Damage Inspection

When using the scan tool, make sure to do the following:

- Before and after each use, check the housing, wiring, and connectors for dirt and damage.
- At the end of each working day, clean the scan tool housing, wiring, and connectors with a clean damp cloth.

## 6.2 Replacing the Batteries

When the AA batteries no longer provide enough charge to power the scan tool, use the following procedure to replace them.

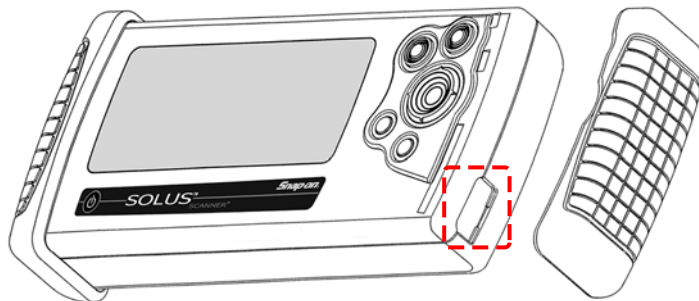
**NOTE:**

We recommend connecting an alternate power source to the scan tool while changing batteries to retain the clock and custom settings. See “Power Supply” on page 10 for options.

---

**To replace the batteries:**

1. Remove the right handgrip.  
The battery slot is exposed (Figure 6-1).



**Figure 6-1** Battery slot

2. Unscrew the battery cover with a flathead screwdriver and remove the cover.

3. Observing proper polarity (shown on the back of the scan tool), install six AA batteries.

---

**IMPORTANT:**

Your scan tool will be damaged if the battery polarity is incorrect. Refer to the diagram on the rear cover of the scan tool for correct battery polarity.

---

4. Replace the cover and tighten the screw.
5. Replace the handgrip.

## 6.3 Storage Tips

When storing your scan tool, remember the following:

- Always turn the scan tool off. See “Powering Off the Unit” on page 17 for details.
- Keep in mind the storage temperature range. See “Technical Specifications” on page 6 for additional information.

## 6.4 Disposing of the Batteries

Always dispose of materials according to local regulations.



The following frequently asked questions provide solutions to common problems.

- “When I first turn on the scan tool, why does it beep but nothing appears on-screen?” on page 66
- “Can I use my other Snap-on® test adapters with this scan tool?” on page 66
- “Why do my batteries drain so quickly?” on page 66
- “What should I do if my printer is not responding?” on page 67
- “What should I do if the unit doesn’t respond as expected when I press the Power button?” on page 67
- “Why does my unit shut down unexpectedly?” on page 67

## A.1 When I first turn on the scan tool, why does it beep but nothing appears on-screen?

The master storage CF card that came with your scan tool must be installed in CF Slot 1 for the unit to operate.

## A.2 Can I use my other Snap-on® test adapters with this scan tool?

Yes.

## A.3 Why do my batteries drain so quickly?

The internal AA batteries are not intended as the scan tool’s primary power source. The internal batteries are intended to maintain the time, date, and custom settings, as well as to power the unit during the vehicle identification process.

During testing, the unit should receive power from a vehicle diagnostic connector or the AC/DC power supply.

For related information, see the following sections:

- “Battery Power” on page 10
- “Installing the Batteries” on page 14
- “Power Management” on page 55

## A.4 What should I do if my printer is not responding?

It may take a minute or two before the printer receives the print request.

If there is still no response after a few minutes, make sure the following conditions are met:

- The printer is receiving power and is turned on.
- The printer has paper.
- The infrared output on top of the scan tool is pointed at the infrared input on the printer.
- The scan tool is less than a few feet from the printer.

For related information, see the following sections:

- “IR Output” on page 10
- “Setting Up to Print” on page 16
- “Printing” on page 51

## A.5 What should I do if the unit doesn't respond as expected when I press the Power button?

An emergency reset button on the back of the unit under the left hand grip will shut down and then restart the unit. See “Emergency Restart” on page 69 for details.

If the emergency reset button fails to correct the problem, remove all sources of power for at least two minutes, then reconnect the power sources and press the Power button.

## A.6 Why does my unit shut down unexpectedly?

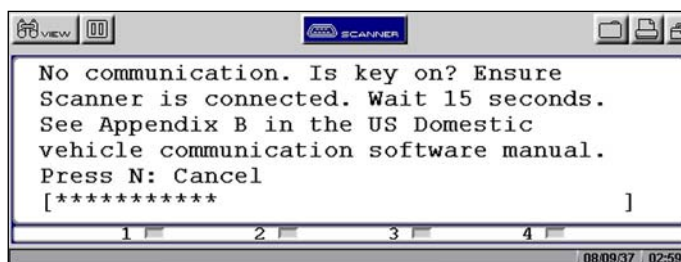
Your internal batteries could be low. We recommend that you check all power sources.

See “Supplying Power” on page 13 for more information.

This section addresses issues that may arise when using the scan tool.

## B.1 No Communication Message

The screen displays a “No Communication” (Figure B-1) message when the scan tool and the vehicle control module cannot communicate with each other for some reason.



**Figure B-1** Sample No Communication message

The following conditions will cause the scan tool to display a “No Communication” message:

- The scan tool is unable to establish a communication link with the vehicle.
- You are using the incorrect Personality Key™ device with the test adapter.
- You select a system for testing that is not part of the vehicle equipment (for example, ABS on a vehicle without anti-lock brakes).
- There is a loose connection.
- There is a blown vehicle fuse.
- There is a wiring fault on the vehicle.
- Incorrect vehicle identification is entered.

Refer to the appropriate Vehicle Communication Software User’s manual, included on the documentation CD, for manufacturer-specific problems.

## B.2 Unit Will Not Power On

The following conditions will prevent your scan tool from powering on:

- No or expired internal batteries (see “Battery Power” on page 10 and “Installing the Batteries” on page 14)
- No master storage CF card in CF Slot 1
- You are connected to a vehicle diagnostic connector that does not supply power, requiring the auxiliary power cables (see “Auxiliary Power Cables” on page 12 and “Connecting to Vehicle Power” on page 14)

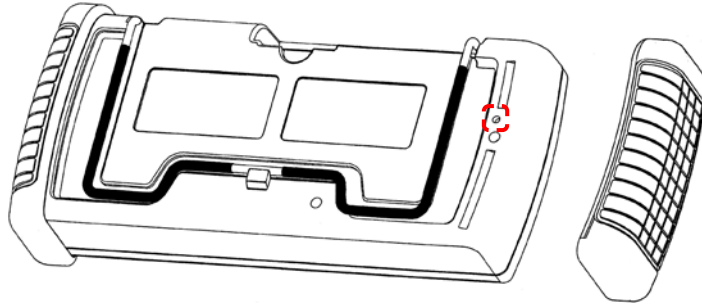
## B.3 Emergency Restart

If your scan tool freezes or will not power off, you can perform an emergency restart.



**To perform an emergency restart:**

1. Remove the left handgrip.
2. Locate the emergency restart button on the back of the unit (Figure B-2).



**Figure B-2** *Emergency restart button location*

3. Gently insert a toothpick or some other non-metallic item into the opening and depress the emergency restart button slot.  
The unit restarts.

# Downloading and Installing Software Updates

Following are instructions for downloading software updates from the internet and installing the updates onto the SOLUS™ scan tool.

## C.1 Check for Service Upgrades Before Use

To download and install software service upgrades you need a personal computer (PC) running ShopStream Connect™ software, which is a free downloadable program.

Improved versions of the operating system software for your handheld diagnostic tool periodically become available at no cost to you. These “service upgrades”, which are the result of an ongoing research and development program, are available through the internet. It is important to check for available upgrades before using your diagnostic tool for the first time, and on a regular basis after that, to ensure you have the latest version of the software.

Following are procedures for:

- Verifying your PC meets the minimum requirements for ShopStream Connect™ software
- Downloading and Installing ShopStream Connect™ software on your PC
- Downloading service upgrades to your SOLUS scan tool

## C.2 Verifying Minimum PC Requirements

---

**IMPORTANT:**

If your PC does not meet the minimum requirements, do not attempt to install the ShopStream Connect software.

---

Before installing the software, verify your PC meets the following requirements:

- System Properties:
  - Operating system—Microsoft Windows 2000 Service Pack 4, Windows XP, or Vista. The system must be upgraded to Microsoft .NET Framework Version 2.
  - Processor—Pentium 4 or later, or equivalent
  - Memory—256 MB minimum, 512 MB recommended
- Hard Drive—50 MB free space
- CD-ROM, DVD, or DVD-ROM drive
- USB 2.0 or later
- Internet Explorer 6.0 or higher
- Internet connection
- Adobe Reader software (free download at [www.adobe.com/products/reader](http://www.adobe.com/products/reader))

A type A/B USB cable is also needed to connect the SOLUS scan tool to the PC.

## C.2.1 Verifying PC System Properties

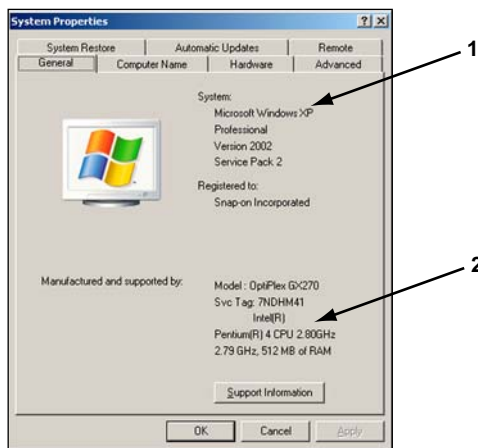
Follow the procedures below to check your PC system properties and to determine how much free space is available on your hard drive.



### To check your PC system properties:

1. On the Desktop, right-click **My Computer** to open the menu.
2. Select **Properties** from the menu.

The **System Properties** dialog box displays with your system information (Figure C-1).



- 1— System property information
- 2— Hard drive information

Figure C-1 Sample Windows XP System Properties dialog box



### To check PC hard drive free space:

1. On the Desktop, double-click **My Computer**.
2. Select **View > Details** (Figure C-2).

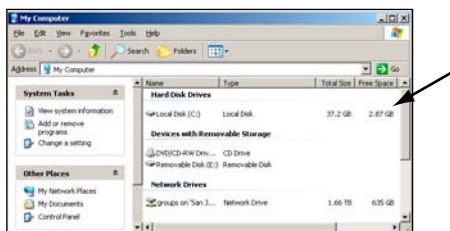


Figure C-2 Sample PC hard drive free space details

## C.3 Downloading and Installing ShopStream Connect

Follow the procedure below to download the ShopStream Connect software.



**To download the software:**

1. From your PC, go to <http://diagnostics.snapon.com/scc> using your Internet browser.
2. Locate the ShopStream Connect software download.
3. Follow the on-screen instructions.

After downloading, follow the procedures below to install the ShopStream Connect software onto your PC.



**To install the ShopStream Connect software:**

1. Locate the ShopStream Connect software installer on the PC and double-click **ShopStreamConnect.exe**



**NOTE:**

C:\Program Files\ShopStream Connect is the default download location.

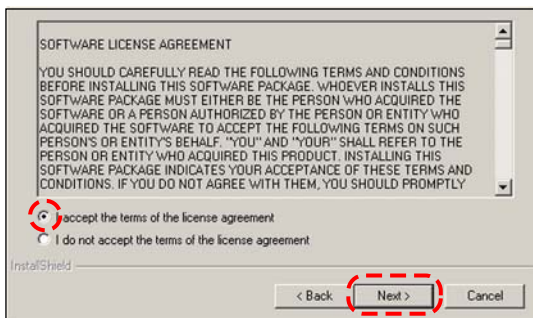
2. When the welcome screen displays (Figure C-3), select **Next**.



**Figure C-3** Sample Welcome screen

The License Agreement screen displays (Figure C-4).

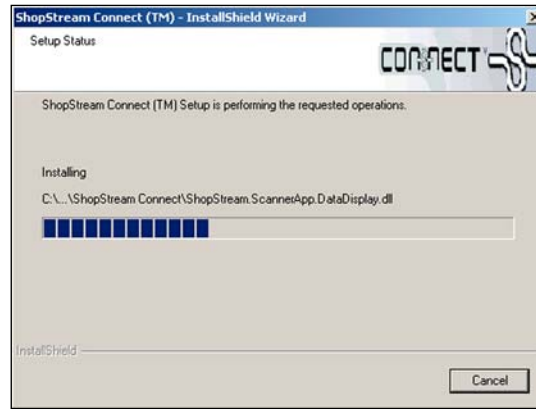
3. Highlight **I accept the terms of the license agreement** and select **Next** to continue.



**Figure C-4** Sample License Agreement screen

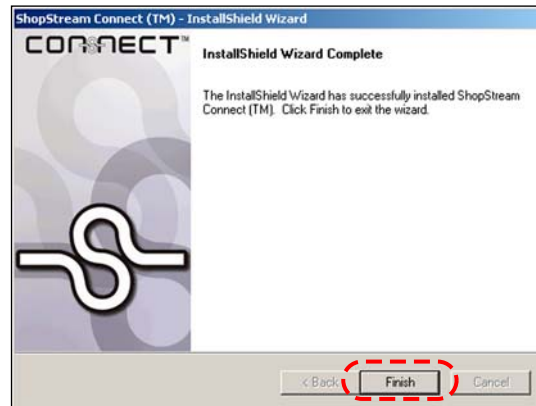
The Choose Destination Location screen displays. It is highly recommended to allow the software to install in the default location.

4. Select **Next** to continue.
5. Select **Install** when the Ready to Install the Program screen displays to begin the installation. The Setup Status screen tracks progress as the program installs (Figure C-5).



**Figure C-5** Sample Setup Status screen

6. When the Complete screen displays, select **Finish** to close the Install Wizard (Figure C-6).



**Figure C-6** Sample Complete screen

A ShopStream Connect shortcut icon is added to your desktop (Figure C-7), double-click the icon to launch the ShopStream Connect software.



**Figure C-7** Sample ShopStream Connect Desktop icon



## C.4 Downloading Service Upgrades

The ShopStream Connect software allows you to download service upgrades directly to your handheld diagnostic tools, as well as update its own software. The following pages contain a brief description for installing a service upgrade on a handheld tool. Detailed procedures for updating the ShopStream Connect software, connecting handheld diagnostic tools to the PC, and other operations are found in the ShopStream Connect User’s Manual. The ShopStream Connect User’s Manual is available from the Help button on the ShopStream Connect toolbar (Figure C-8).



Figure C-8 Sample ShopStream Connect help menu

### C.4.1 Before You Begin

Prior to downloading a service upgrade, be sure to have the following items on hand:

- A PC with ShopStream Connect software and an internet connection
- The AC/DC Power Supply for the SOLUS scan tool
- A type A/B USB cable

---

**IMPORTANT:**

An uninterrupted power source to the diagnostic tool is crucial during an upgrade, as any loss of power may damage the tool and render it inoperative. Therefore, use of the AC/DC Power Supply is highly recommended. Do not rely on partially-charged batteries.

---

### C.4.2 Installing a Service Upgrade

Once you have the required items available, use the procedure below to install an upgrade.



**To install a service upgrade:**

1. Connect the AC/DC Power Supply to the DC power supply input port on SOLUS and a reliable power source.
2. Power on the SOLUS scan tool.
3. From the SOLUS main menu, select **Utilities** > **Connect to PC** to place the scan tool in Connect to PC mode.
4. Connect the USB cable between the USB port on top of the SOLUS scan tool and a USB port on the PC.

A “Removable Disk” window may automatically open on the PC (Figure C-9). If so, select **Cancel** to close the window.

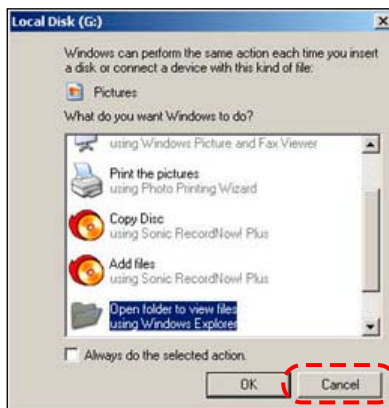


Figure C-9 Sample removable disk window

- 5. Double-click the desktop icon to launch ShopStream Connect (Figure C-7).
- 6. Once ShopStream Connect opens; select Tools > Update Software > SOLUS from the Menu bar (Figure C-10).

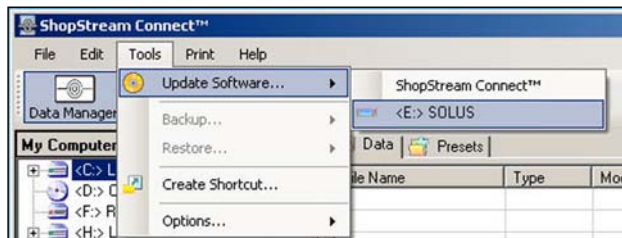


Figure C-10 Sample Update Software menu

When connectivity is established with the Snap-on Web server, a check for updates confirmation message displays (Figure C-11).

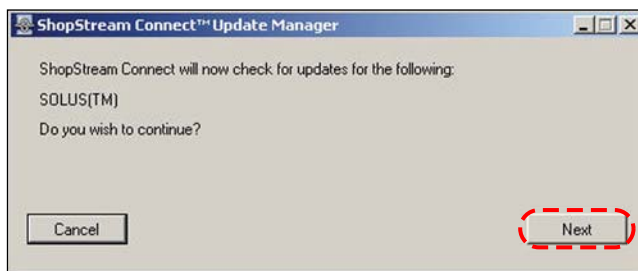


Figure C-11 Sample Check for updates screen

- 7. Select **Next** to continue and the software checks to see if an upgrade is available:
  - a. If no upgrades are available, an updates not found message displays (Figure C-12). Select **Finish** to close the Update Manager, then skip ahead to Step 9.



**Figure C-12** Sample no updates available screen

- b. If an upgrade is available, an updates found message displays (Figure C-13). Select **Download** to begin the upgrade process and continue to Step 8.



**Figure C-13** Sample update available screen



**NOTE:**

Each service upgrade is unique. The time involved will vary and some additional steps may be required. Follow any on-screen instructions to complete the process.

8. When the “complete” message displays, select **Finish** to close the Update Manager.
9. Remove the USB cable to disconnect the tool from the PC.
10. Press the **Power** button on SOLUS to exit Connect to PC mode.  
The upgrade is now downloaded, but not installed. The installation process automatically begins when SOLUS is powered on. SOLUS should automatically reboot after exiting Connect to PC mode. If not, power on the tool.
11. After SOLUS powers on, the upgrade installation begins. The install may take several minutes and a series of screens tracks the progress. Do not press any buttons or disrupt power during the installation.  
When the main menu displays, the installation is complete and your SOLUS scan tool is ready for use.

# Index

## A

- AA batteries
  - installing 15
  - replacing 64
  - technical specifications 7
  - time, date, and custom settings 10
- AC power adapter 11
- adapters. *See* test adapters
- Auto scale 37
- auxiliary power cables
  - battery power cable 12
  - lighter power cable 12
  - vehicle power 10, 14

## B

- batteries. *See* AA batteries
- battery cover
  - removing 15, 64
- battery power cable. *See* auxiliary power cables
- brightness/contrast 5, 18
  - See also* buttons
- buffer bar 19, 21
- buttons 5, 8

## C

- cables 11
- casing hook 6
- changing screen views 33–38
  - See also* upper toolbar
- cleaning the unit 64
- clearing codes 29
- clearing data 42
- Codes Menu 28–30
- Color Theme 59
- CompactFlash® cards
  - slot locations 5
  - slot technical specs 6
- component tests 30
- confirmation messages 23
- Connect to PC 62
- connecting to a vehicle 24, 26
- connecting to vehicle power 14
- Custom Setup 52
- customizing a data list 53

## D

- damage inspection 64

- data cable 11
  - See also* power supply
- data cable connector 5, 10
- data cable extension
  - accessory 12
- Data Display 27
- data parameters
  - customizing list 53
  - displaying 28
  - Graph views 35
  - pausing 41
  - PID List view 33
  - reviewing 33
  - Text view 35
- data storage CF card 6
- Date 58
- DC power jack
  - AC adapter 9
  - location 5
- disposal requirements 64
- DTC status 29

## E

- Easy Scroll 22, 62
- error messages 23
- exiting Scanner mode 32

## F

- Freeze Frame/Failure Records 29
- frequently asked questions 66
- functional tests 30

## G

- getting started 13
- graphing data
  - Graph mode 35–50
  - parameter menu 36

## H

- handgrips 5
  - removing 15, 64, 69
- hanging position. *See* stand

## I

- identifying a test vehicle 24, 25
- information tests 30

infrared (IR) port  
  location 5  
inspecting unit for damage 64  
installing batteries 14  
internal batteries. *See* AA batteries

**L**

LCD screen 5  
LED indicators 19  
lighter power cable. *See* auxiliary power cables  
locking a parameter 34  
locking data parameters 36

**M**

main body 22  
maintenance tips 64  
making selections 22  
manual conventions  
  description 1  
  notes 2  
Manual scale 37  
manuals, software 3  
manufacturer  
  selecting 25  
manufacturer selection (vehicle) 24

**N**

navigating 19

**O**

operating temperature range 7  
operations 24  
  connecting to a vehicle 24, 26  
  identifying a test vehicle 24, 25  
  selecting a system to test 24, 26  
  selecting software 24  
  selecting tests 24, 27  
optional accessories 12

**P**

parameter menu 36  
  clear all trigger levels 36  
  clear trigger levels 36  
  lock 36  
  scale 36  
  set trigger levels 36  
parameters  
  clearing data 34  
  locking 34  
Pause/Play button. *See* upper toolbar  
pausing data 34, 41  
Personality Key™ 68  
PID triggering 39

Play button. *See* upper toolbar  
Power button. *See* buttons  
power cables. *See* auxiliary power cables  
Power Management 55  
power options 17  
power supply  
  connecting to 13–16  
  connecting to vehicle power 14  
  types 10–11  
powering up the unit 16  
Printer 57  
printer setup 16  
printing 51

**R**

replacing the batteries. *See* AA batteries  
reset tests 30  
restarting 69  
review PID 34  
Run 62

**S**

S Button 59  
S button 9  
  location 5  
  *See also* Utilities  
Safety iii–iv  
safety  
  information iii  
  message conventions iii  
safety messages iii–iv  
Save Data 56  
Saved Data  
  capturing 44  
  copying and moving 49  
  deleting files 49  
  identifying files 47  
  loading 48  
  reviewing 48  
  viewing 46  
saved data 46–50  
saving data 44–46  
saving preferences, adjusting 56  
Scale all 38  
scanner button 21  
Scanner mode  
  exiting 32  
  power options unavailable 17  
Scanner Units 56  
Scanner units 52–53  
Scanner View 60  
screen layout 19  
screen messages 23  
selecting a system to test 24, 26

- selecting tests 24
- selecting the manufacturer 25
- set trigger levels 38–39
- ShopStream Connect 17
- shutting down the unit 9, 17
- software
  - exiting 31
  - selecting 24
  - Troubleshooter 4
  - Vehicle Communication 4
- software manuals 3
- sorting data 42
- stand 6, 7–8
- storage temperature range 7
- storage tips 65
- subsystem tests 30
- supplying power. *See* power supply
- system CF card 6
- System Info 62
- system information
  - displaying 63
- System Main Menu 27
- system tests 30
- System Tools 61

## T

- technical specifications 6
- temperature range specifications 7
- terminating vehicle communication 31
- test adapters 11, 14, 68
- tests
  - component 30
  - functional 30
  - selecting 24, 27
  - subsystem 30
  - system 30
- Thumb Pad 5, 8
  - See also* buttons
- Time 58
- toggle tests 30
- Tool Help 3, 61
- Tool Setup 54
- toolbar. *See* upper toolbar
- Tools Button 51
- trigger
  - clearing levels 40
  - condition 39
  - delay 39
  - disarming 40
- Trouble Codes 28
- Troubleshooter 30
- troubleshooting tips 68
- turning off the unit 17

## U

- unit operations. *See* operations
- unlock all 36
- unlock all PIDs 37
- unlock PIDS 37
- unlocking a parameter 35
- upper toolbar
  - buttons and functions 20
  - navigating 22
  - Pause/Play button 33
  - test controls 19
  - Tools button 51
- USB port
  - connecting to PC 9
  - location 5
- using cursors 42–43
- using zoom 43
- Utilities menu 54–63
  - Color Theme 59
  - Connect to PC 62
  - Date 58
  - Easy Scroll 62
  - Power Management 55
  - Printer 57
  - Run... 62
  - S Button 59
  - Save Data 56
  - Scanner Units 56
  - Scanner View 60
  - System Info 62
  - System Tools 61
  - Time 58
  - Tool Help 61
  - Tool Setup 54

## V

- variable control tests 30
- Vehicle Communication menu 25
- vehicle diagnostic connectors 11, 12, 14, 26
- vehicle identification. *See* identifying a test vehicle
- vehicle power. *See* power supply

## W

- warning messages 23

## Y

- Y button. *See* buttons

